

US00D464082S

(12) **United States Design Patent**
Yamada et al.

(10) **Patent No.:** **US D464,082 S**

(45) **Date of Patent:** **** Oct. 8, 2002**

(54) **INK CARTRIDGE**

(75) Inventors: **Manabu Yamada**, Matsumoto (JP);
Chiyoshige Nakazawa, Suwa (JP)

(73) Assignee: **Seiko Epson Corporation**, Tokyo (JP)

(**) Term: **14 Years**

(21) Appl. No.: **29/141,589**

(22) Filed: **May 10, 2001**

(30) **Foreign Application Priority Data**

Nov. 10, 2000	(JP)	2000-032240
Nov. 10, 2000	(JP)	2000-032244
Nov. 10, 2000	(JP)	2000-032245

(51) **LOC (7) Cl.** **18-02**

(52) **U.S. Cl.** **D18/56; 347/86**

(58) **Field of Search** **D18/43, 56; 347/86,**
347/87

(56) **References Cited**

U.S. PATENT DOCUMENTS

D331,939	S	*	12/1992	Ujita	D18/12
D334,403	S	*	3/1993	Kawakami	D18/56
D419,592	S	*	1/2000	Nakazawa et al.	D18/56
6,053,606	A	*	4/2000	Yamaguchi et al.	347/86
D447,169	S	*	8/2001	Okubo et al.	D18/56
D447,513	S	*	9/2001	Miyazawa et al.	D18/56
D449,642	S	*	10/2001	Yamada et al.	D18/56

* cited by examiner

Primary Examiner—Cathy Anne MacCormac
(74) *Attorney, Agent, or Firm*—Oliff & Berridge, PLC

(57) **CLAIM**

The ornamental design for an ink cartridge, as shown and described.

DESCRIPTION

FIG. 1 is a top view of an ink cartridge according to a first embodiment of the inventive design;
 FIG. 2 is a bottom view thereof;
 FIG. 3 is a left-side view thereof;
 FIG. 4 is a right-side view thereof;
 FIG. 5 is a front view thereof;
 FIG. 6 is a rear view thereof;
 FIG. 7 is a cross-sectional view thereof, taken along the lines 7—7 of FIG. 2;
 FIG. 8 is a cross-sectional view thereof, taken along the lines 8—8 of FIG. 6;
 FIG. 9 is a cross-sectional view thereof, taken along the lines 9—9 of FIG. 4;
 FIG. 10 is a cross-sectional view thereof, taken along the lines 10—10 of FIG. 4;
 FIG. 11 is a cross-sectional view thereof, taken along the lines 11—11 of FIG. 4;
 FIG. 12 is a perspective view thereof; and,
 FIG. 13 is another perspective view thereof.

The broken lines are for illustrative purposes only and form no part of the claimed design.

1 Claim, 8 Drawing Sheets

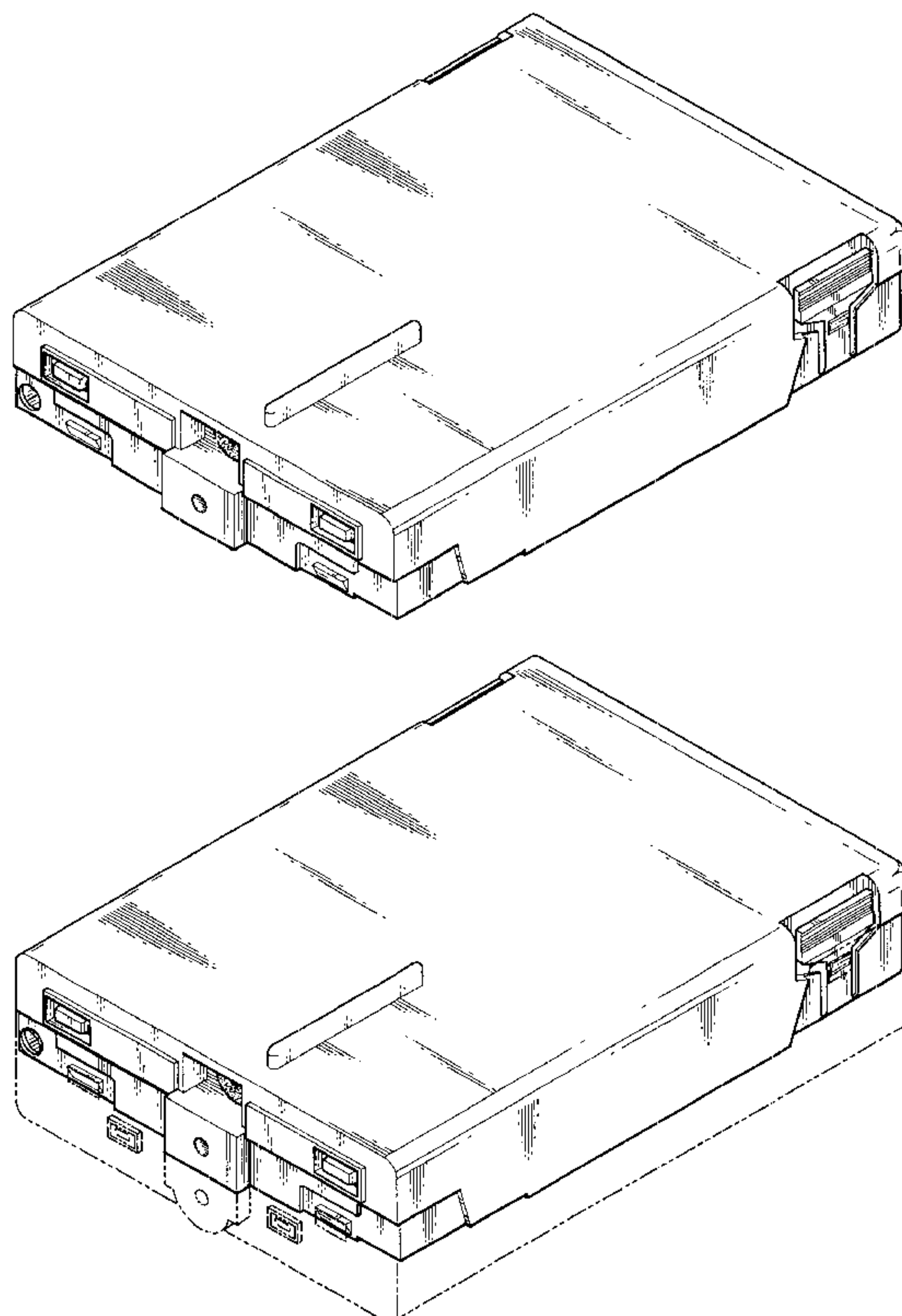

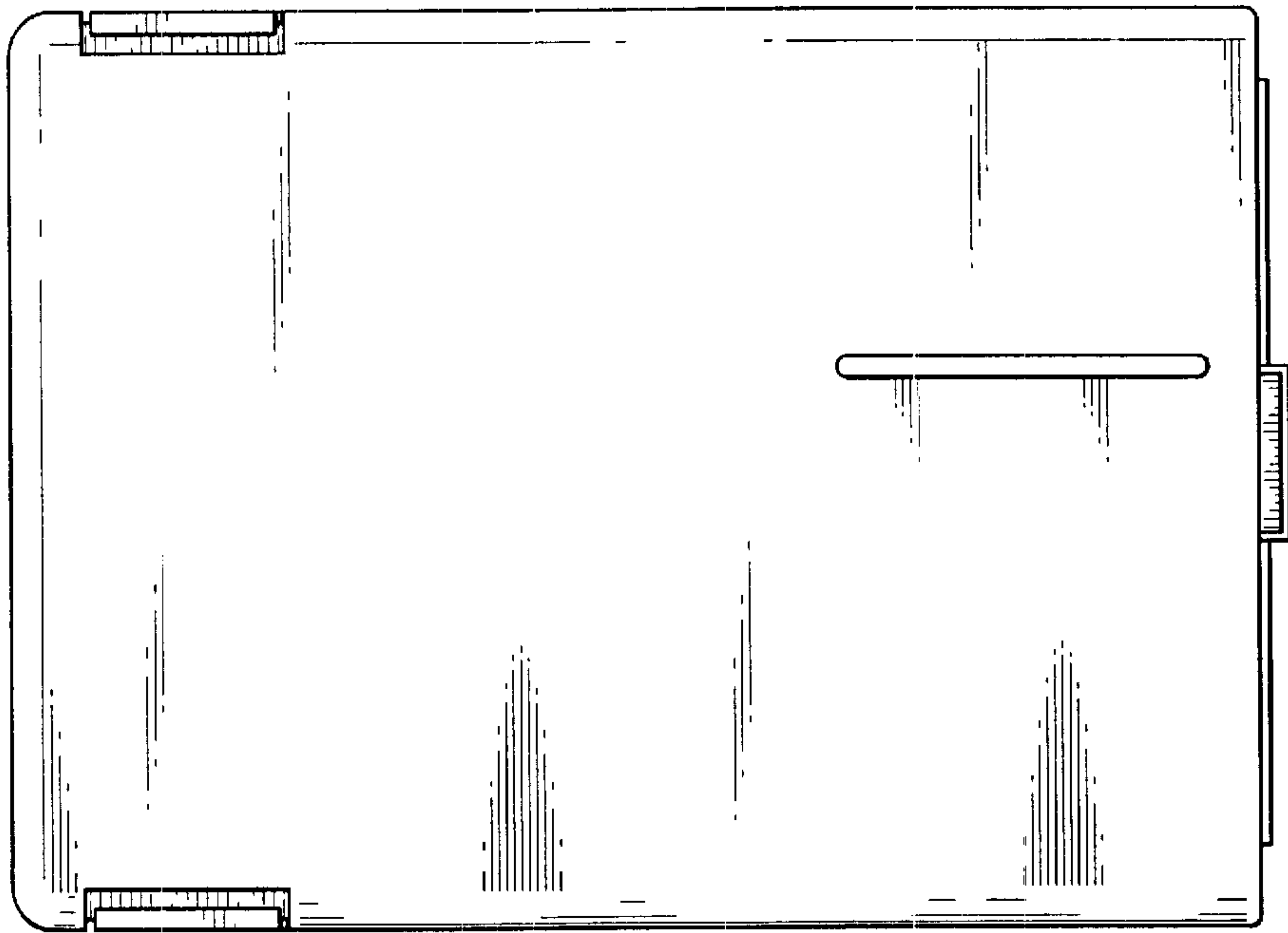

Fig. 1

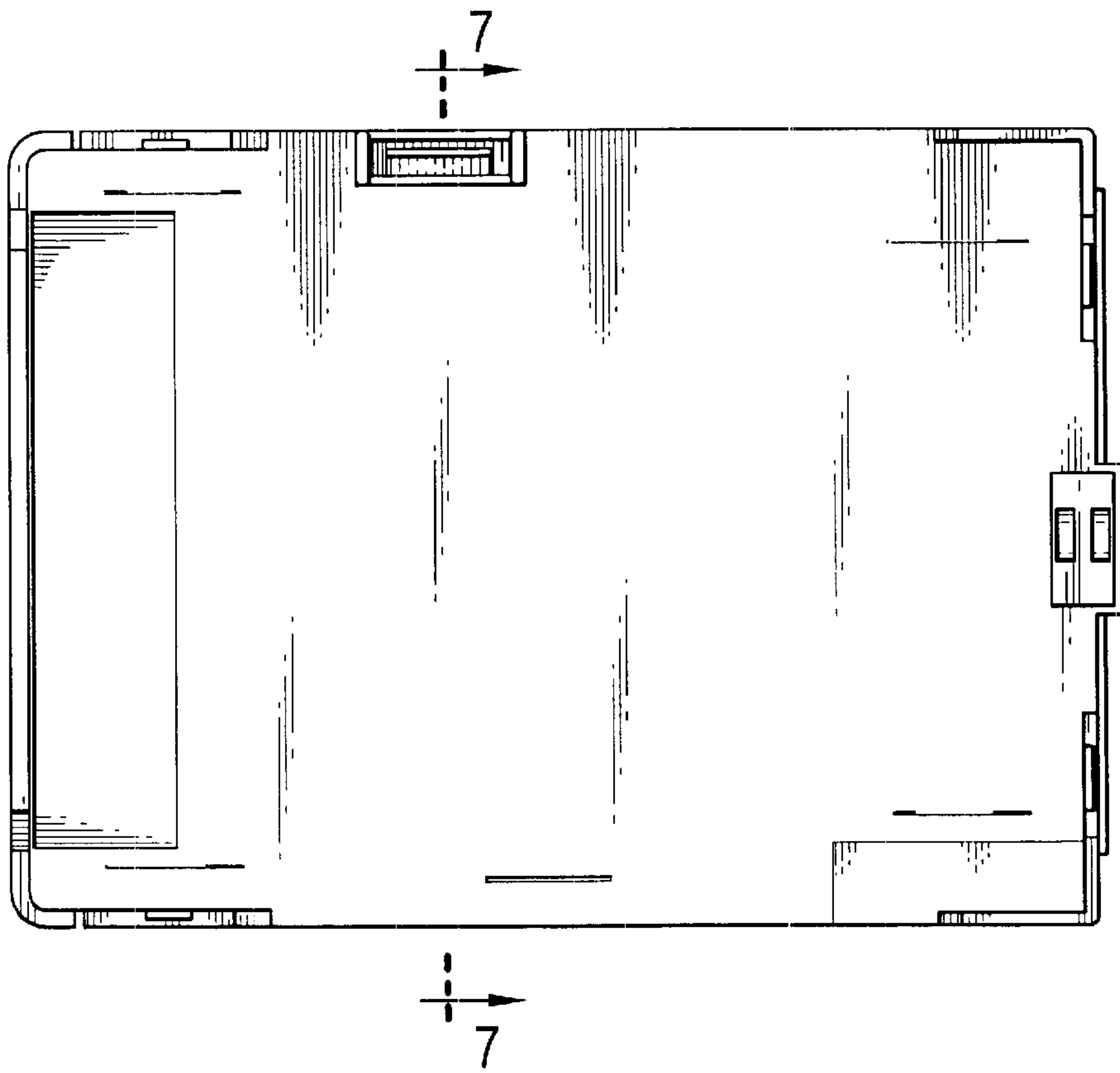

Fig. 2

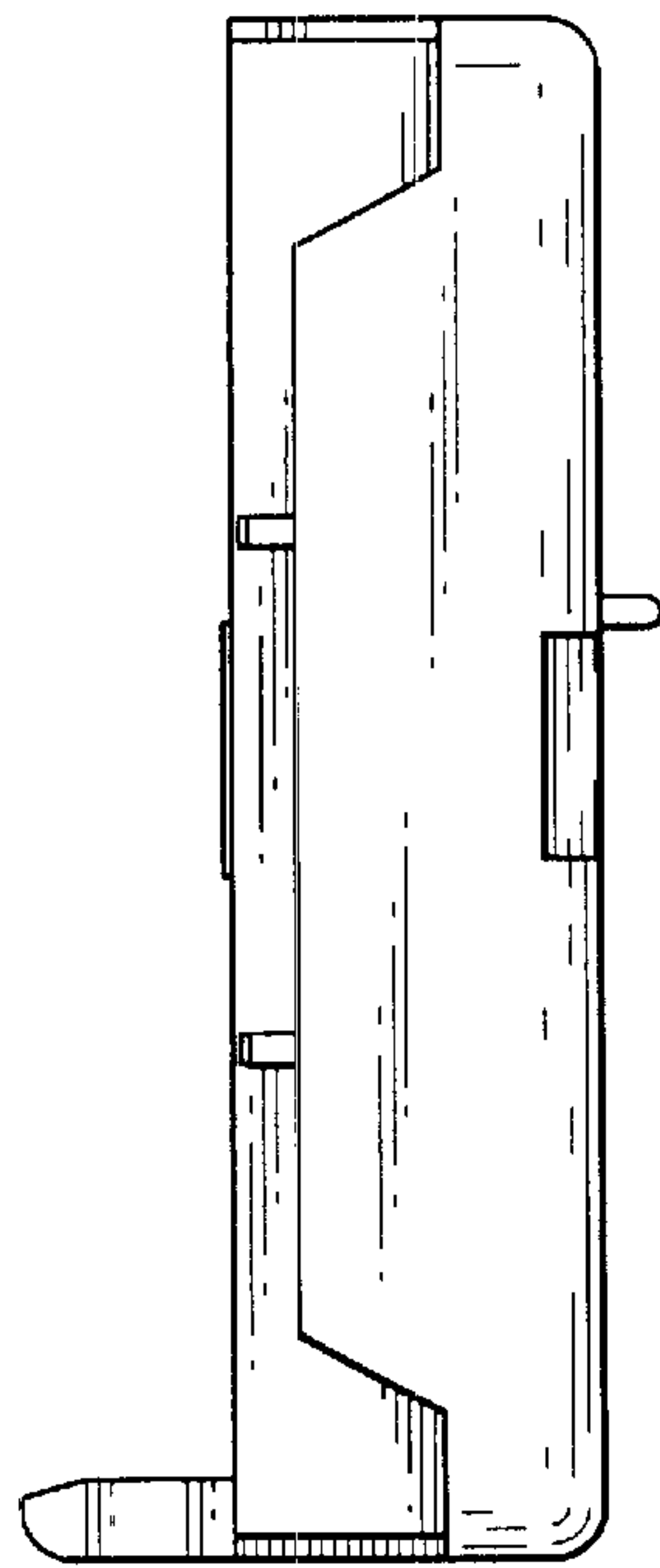

Fig. 3

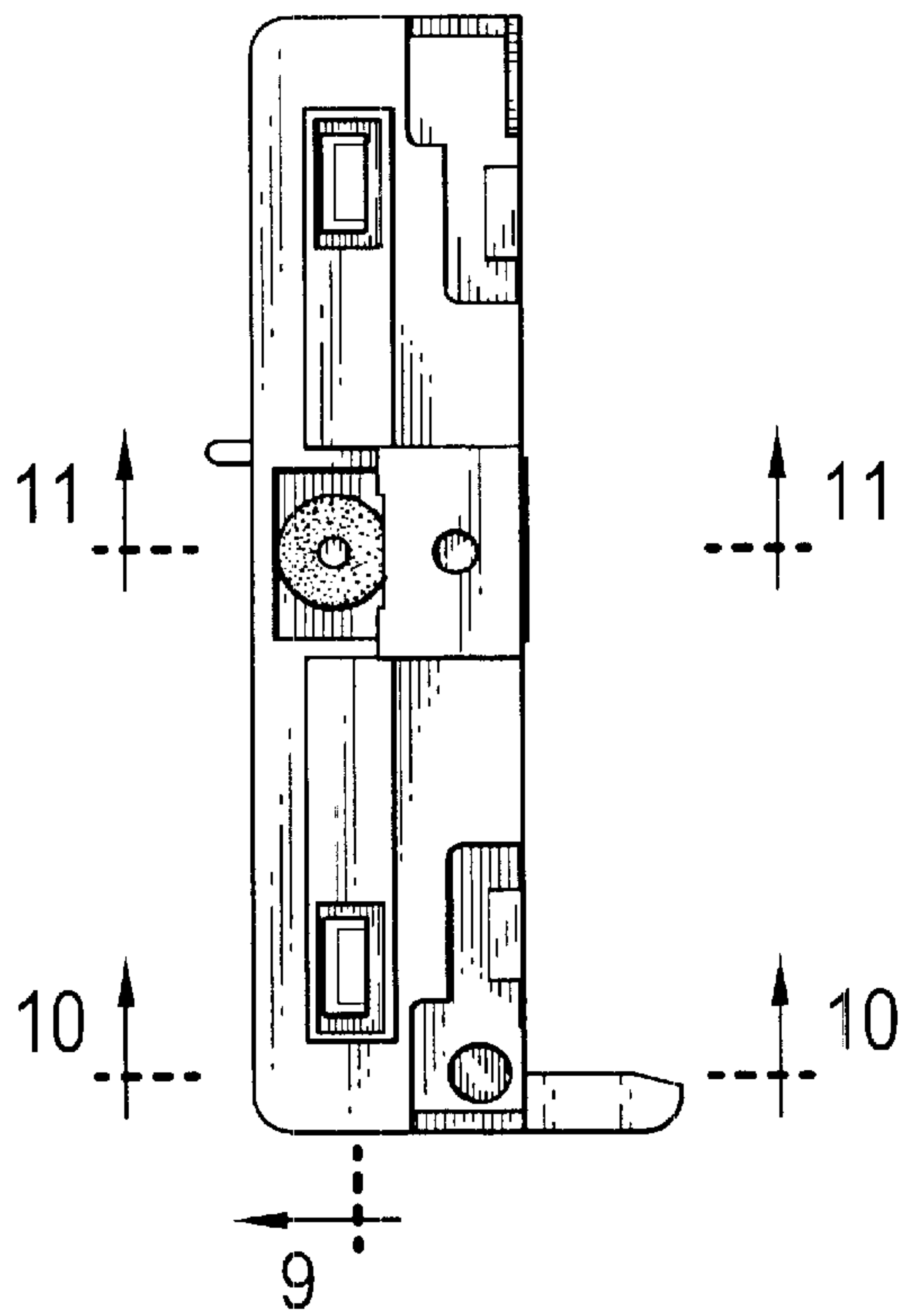
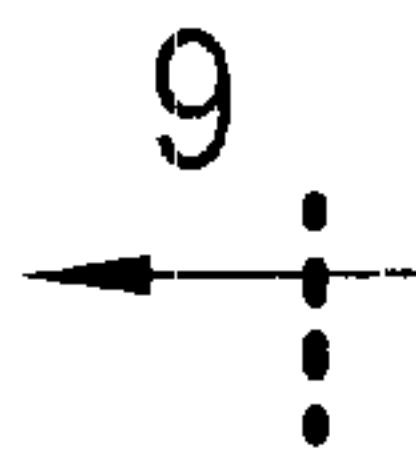

Fig. 4

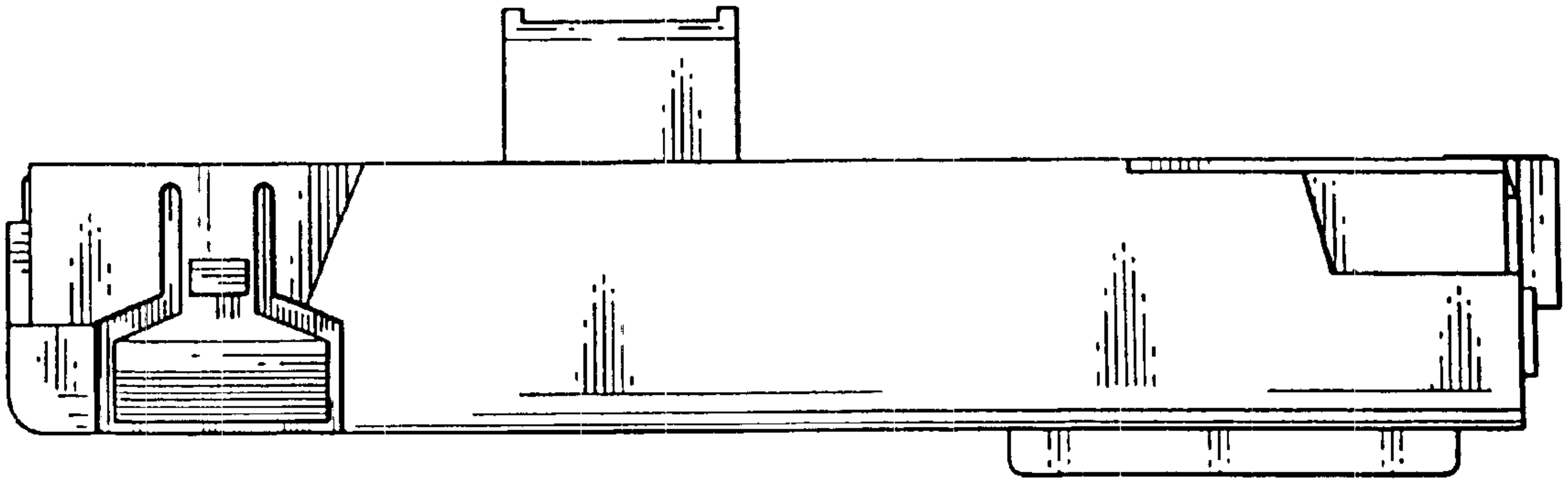

Fig. 5

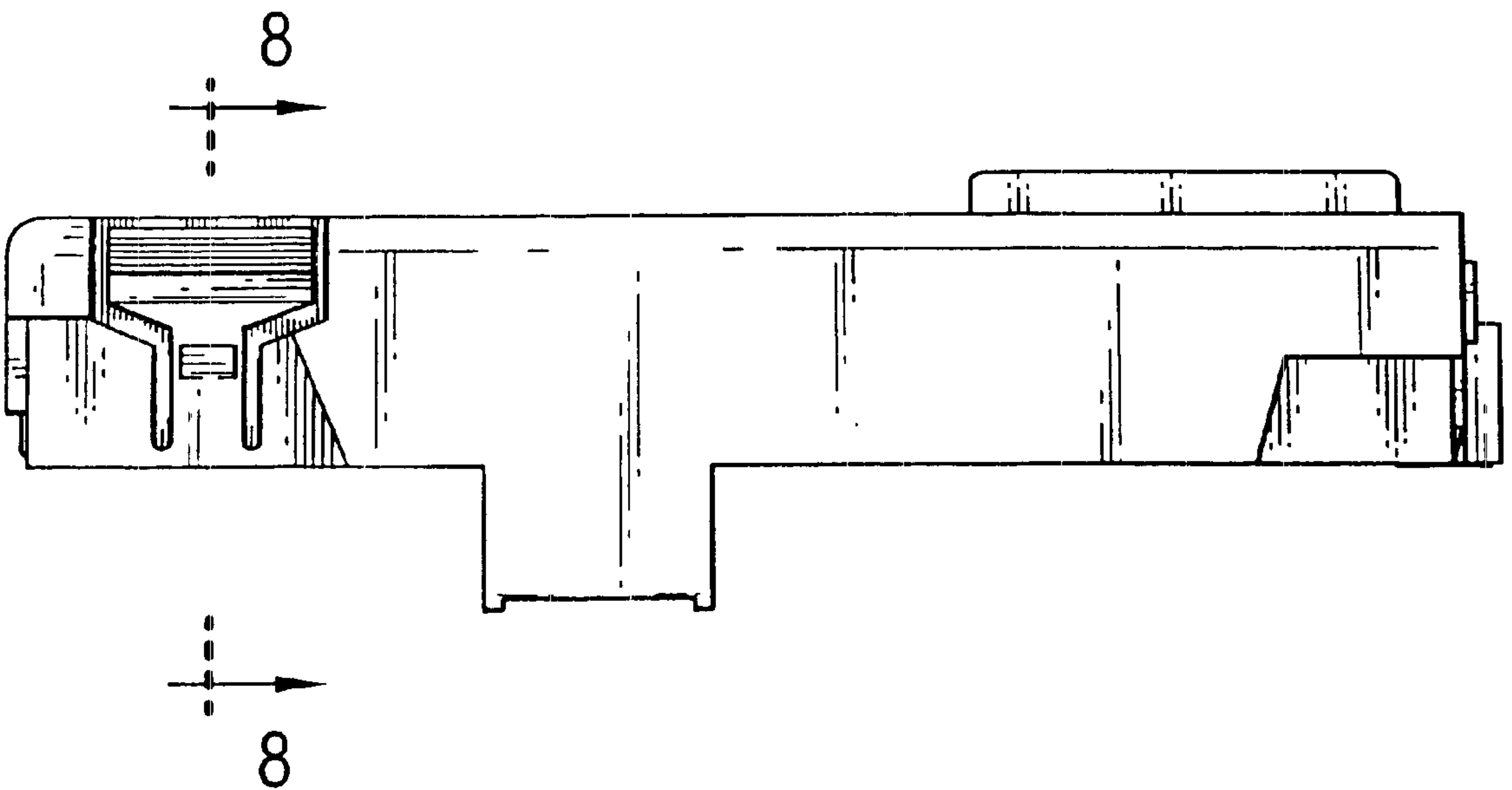

Fig. 6

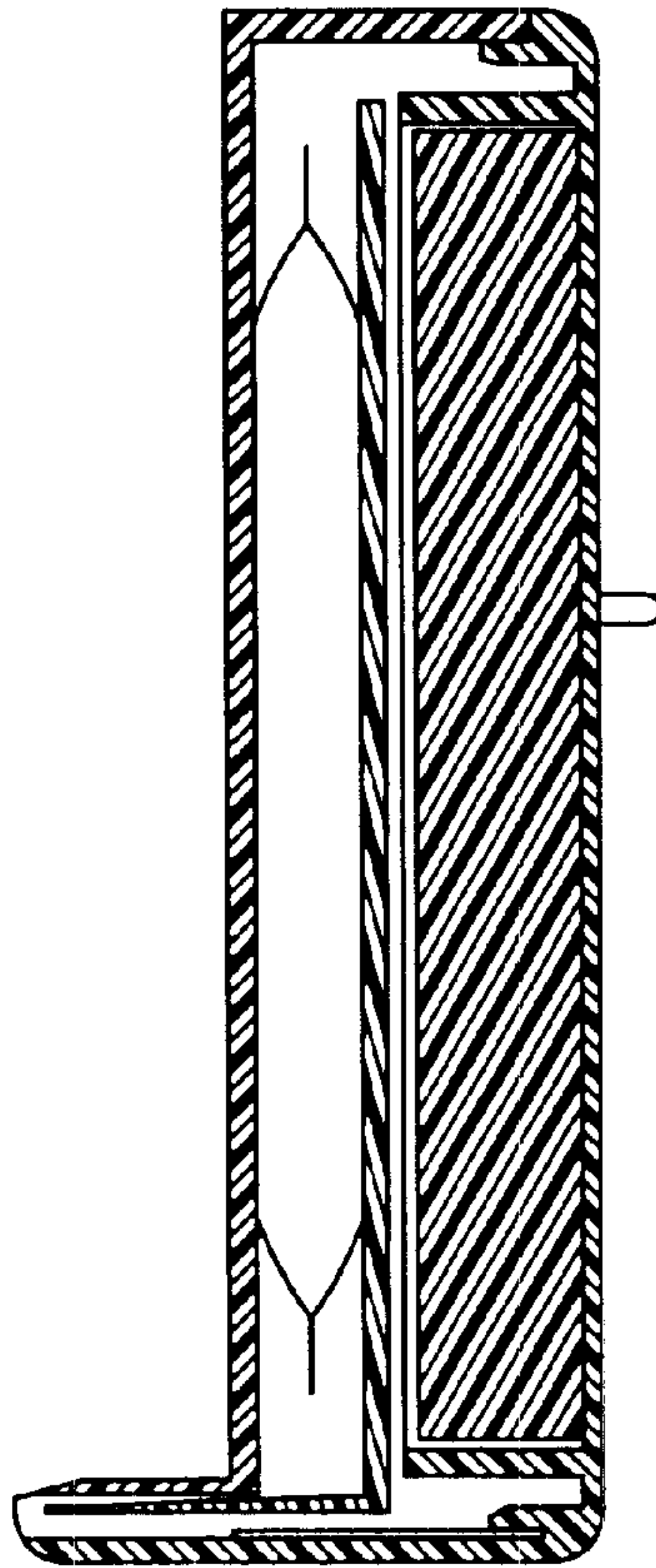

Fig. 7

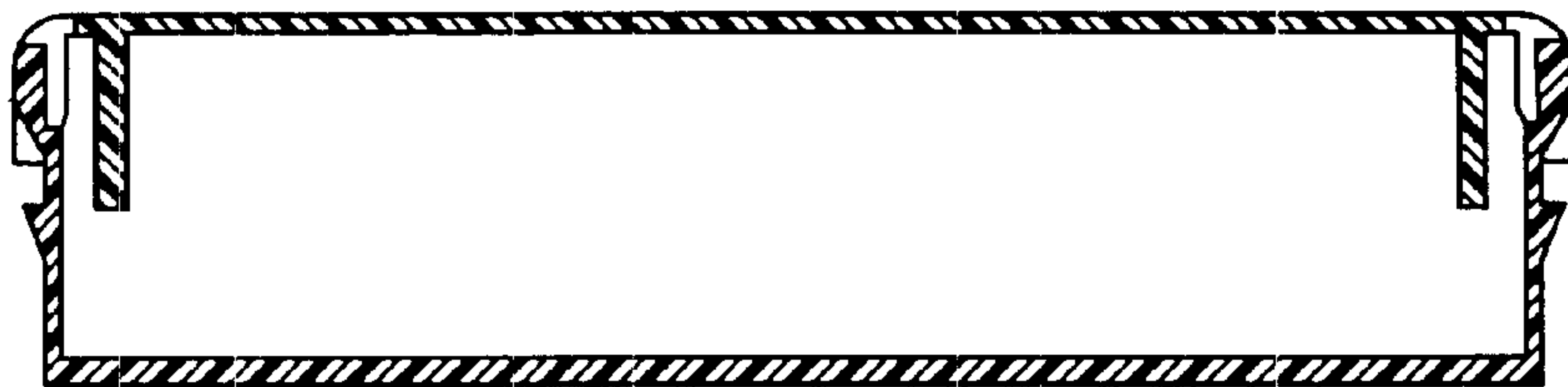

Fig. 8

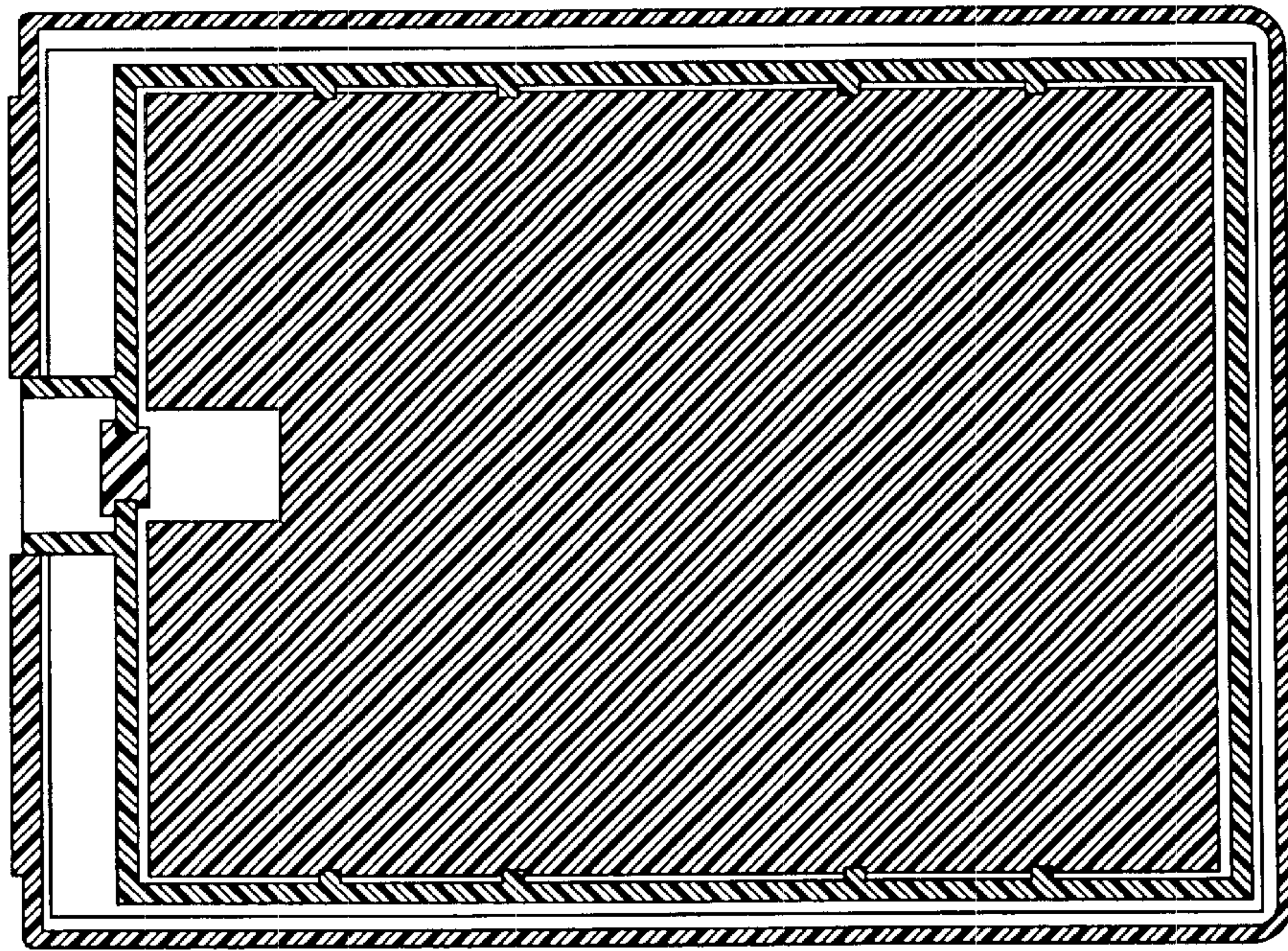

Fig. 9

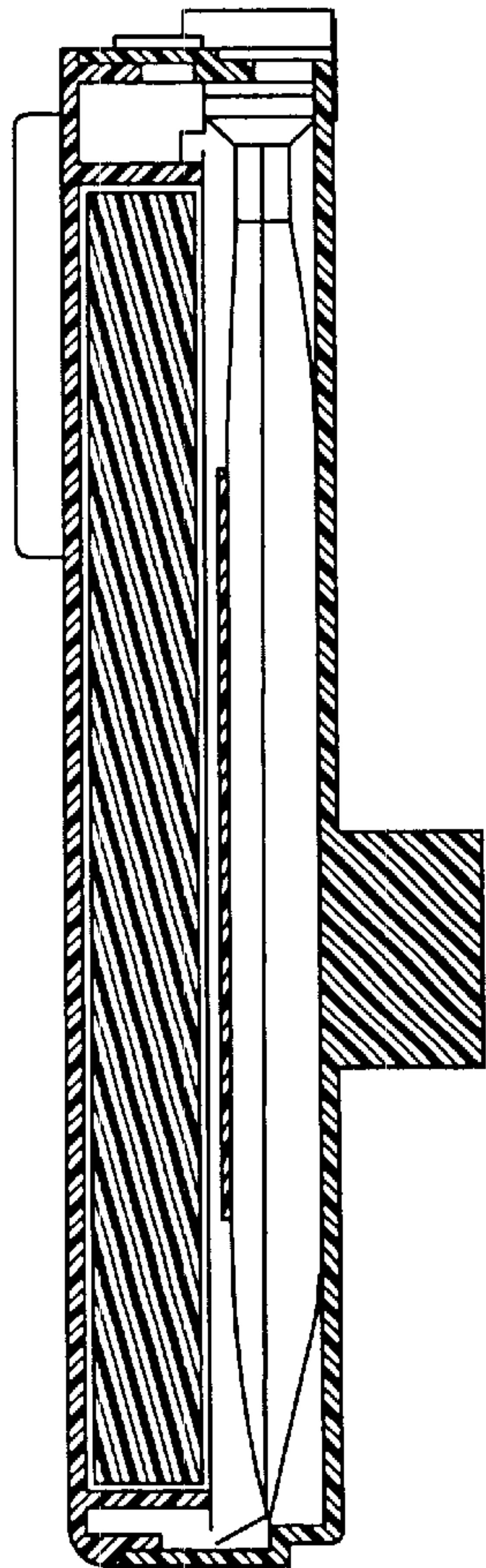

Fig. 10

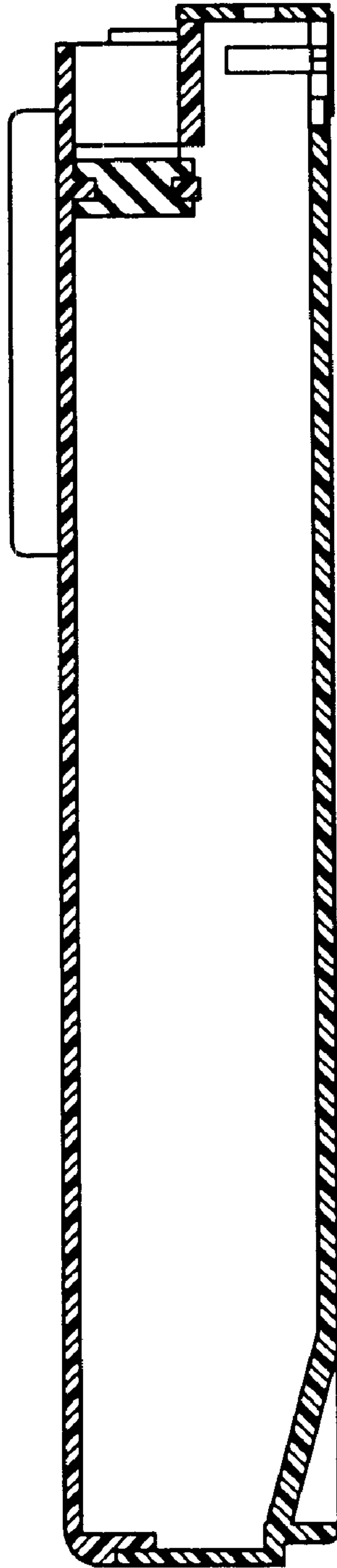

Fig. 11

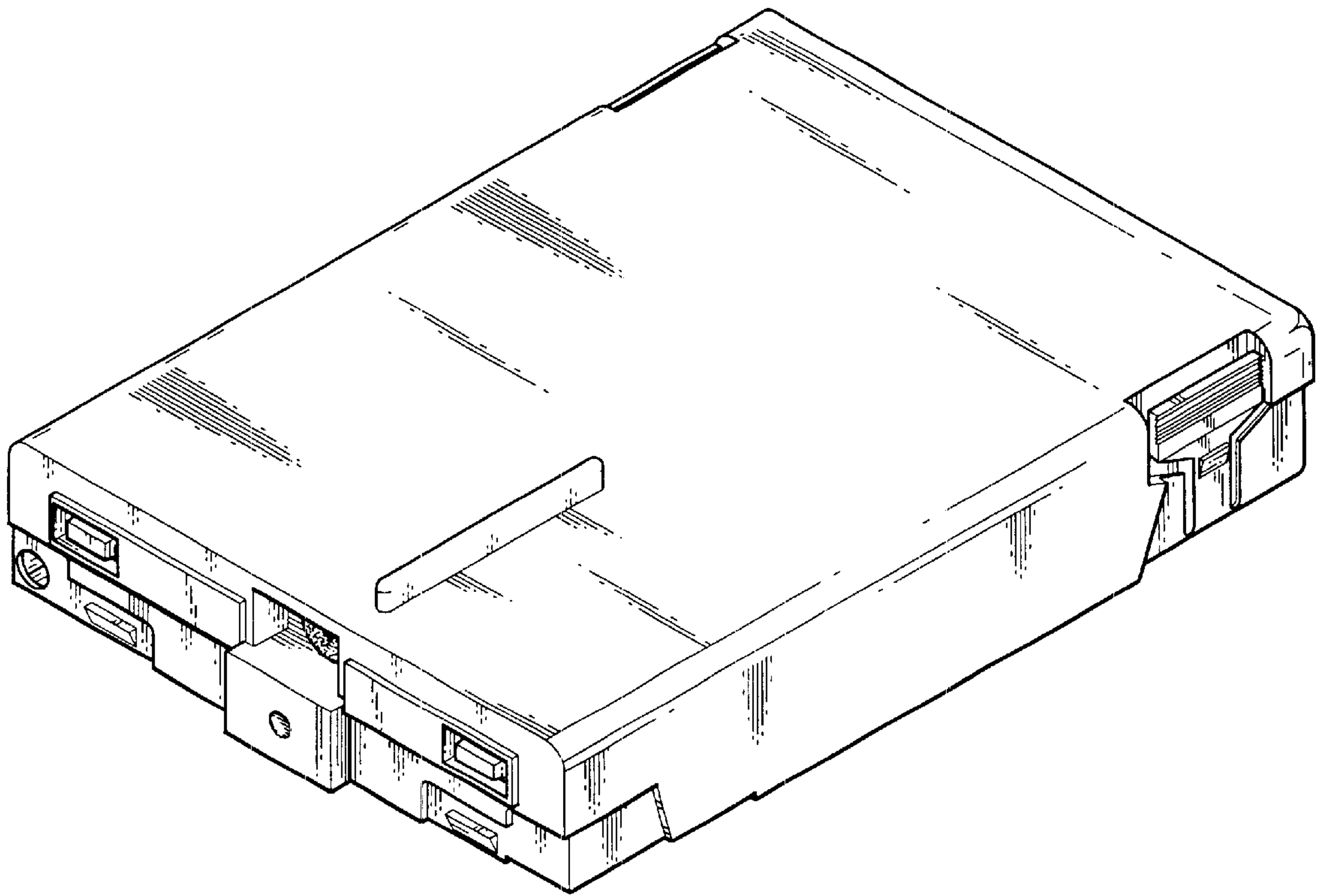

Fig. 12

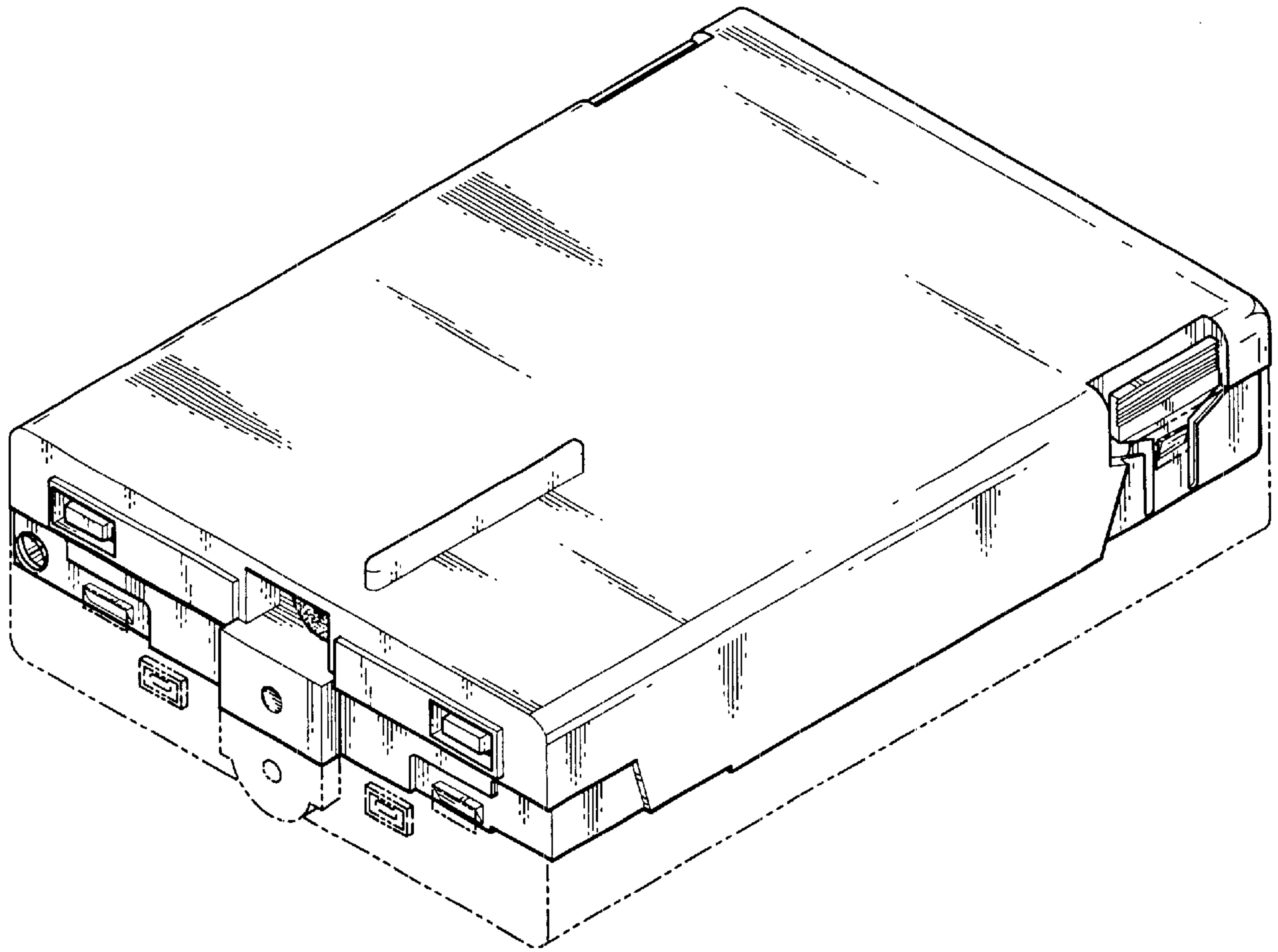

Fig. 13