



US00D463846S

(12) **United States Design Patent**
Ko

(10) **Patent No.:** **US D463,846 S**

(45) **Date of Patent:** **** Oct. 1, 2002**

(54) **FAUCET**

D441,838 S * 5/2001 Haas D23/238

(75) Inventor: **Hsi Chia Ko**, Changhua Hsien (TW)

* cited by examiner

(73) Assignee: **Chung Cheng Faucet Co. Ltd.**,
Changhua Hsien (TW)

Primary Examiner—Louis S. Zarfes

Assistant Examiner—Gregory Andoll

(**) Term: **14 Years**

(74) *Attorney, Agent, or Firm*—Troxell Law Office PLLC

(21) Appl. No.: **29/146,710**

(57) **CLAIM**

The ornamental design for the faucet, as shown and described.

(22) Filed: **Aug. 16, 2001**

DESCRIPTION

(51) **LOC (7) Cl.** **23-01**

FIG. 1 is a perspective view of a faucet showing my new design;

(52) **U.S. Cl.** **D23/238**

FIG. 2 is a front view thereof;

(58) **Field of Search** D23/238-257;
4/675-678; 16/110 R-121; D8/300-308

FIG. 3 is a rear view thereof;

FIG. 4 is a left side view thereof, the right side view being a mirror image thereof;

(56) **References Cited**

U.S. PATENT DOCUMENTS

D323,877 S * 2/1992 Haug et al. D23/238

D429,797 S * 8/2000 Kolada D23/238

FIG. 5 is a top view thereof; and,

FIG. 6 is a bottom view thereof.

1 Claim, 4 Drawing Sheets

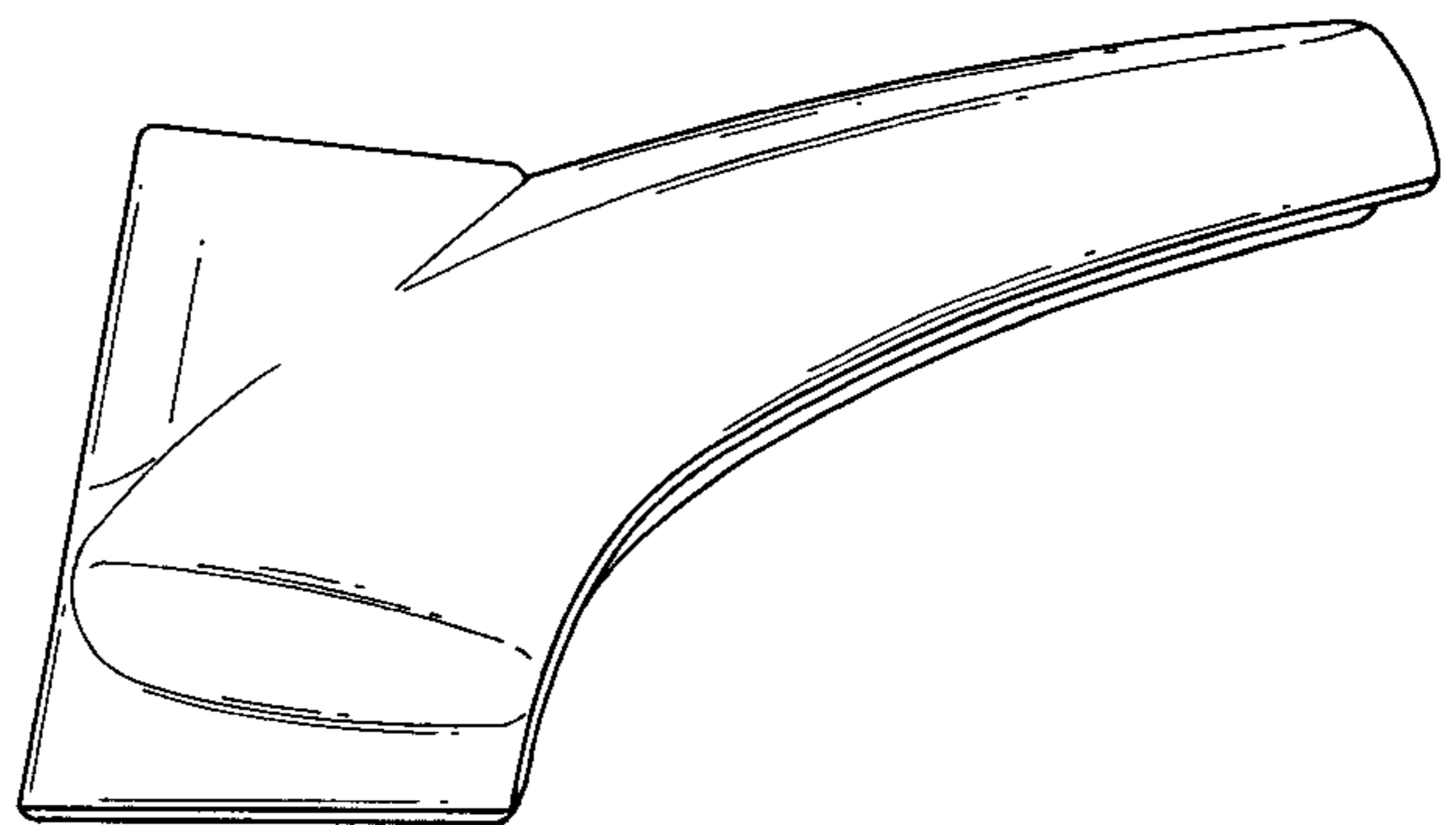
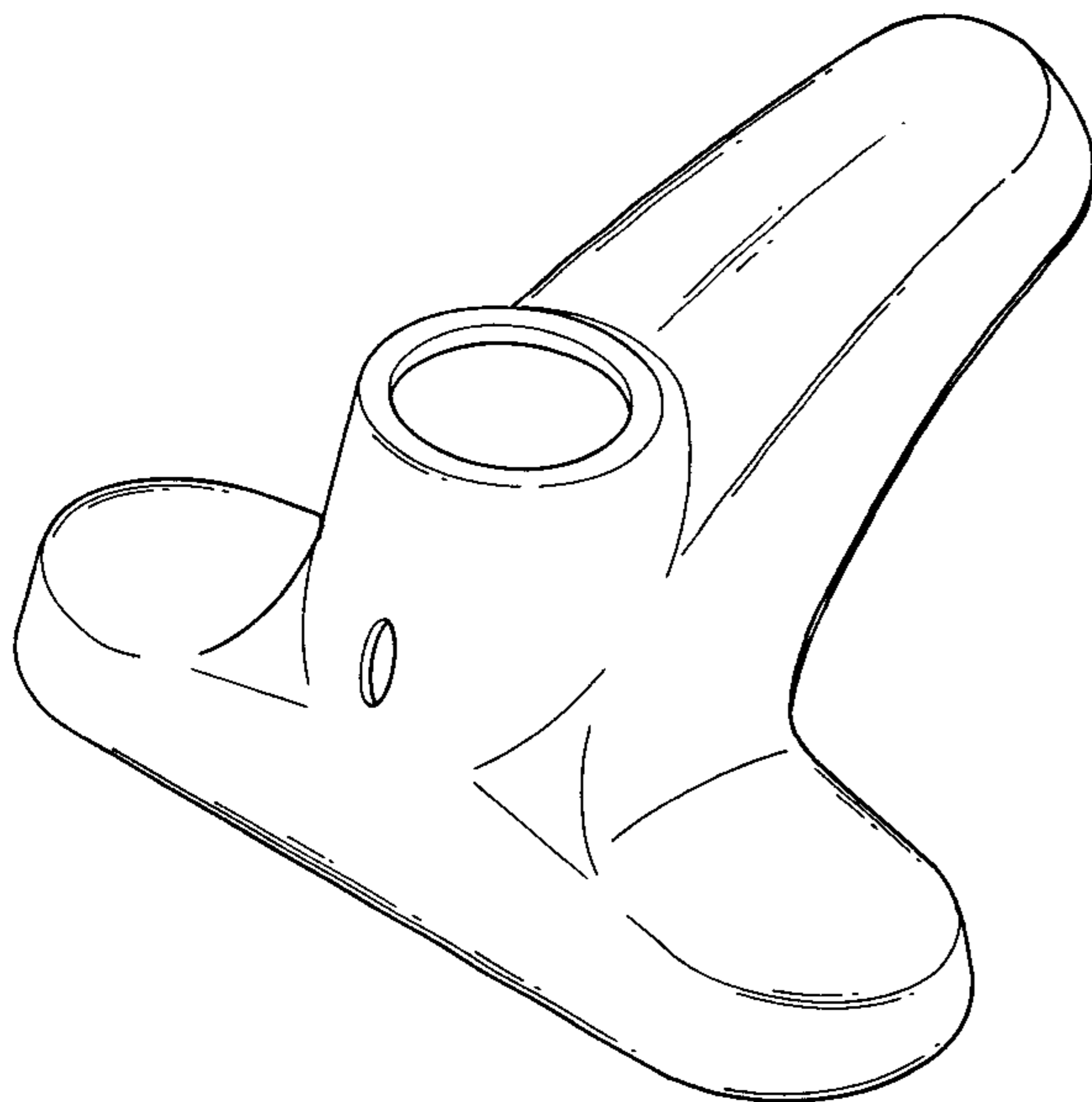

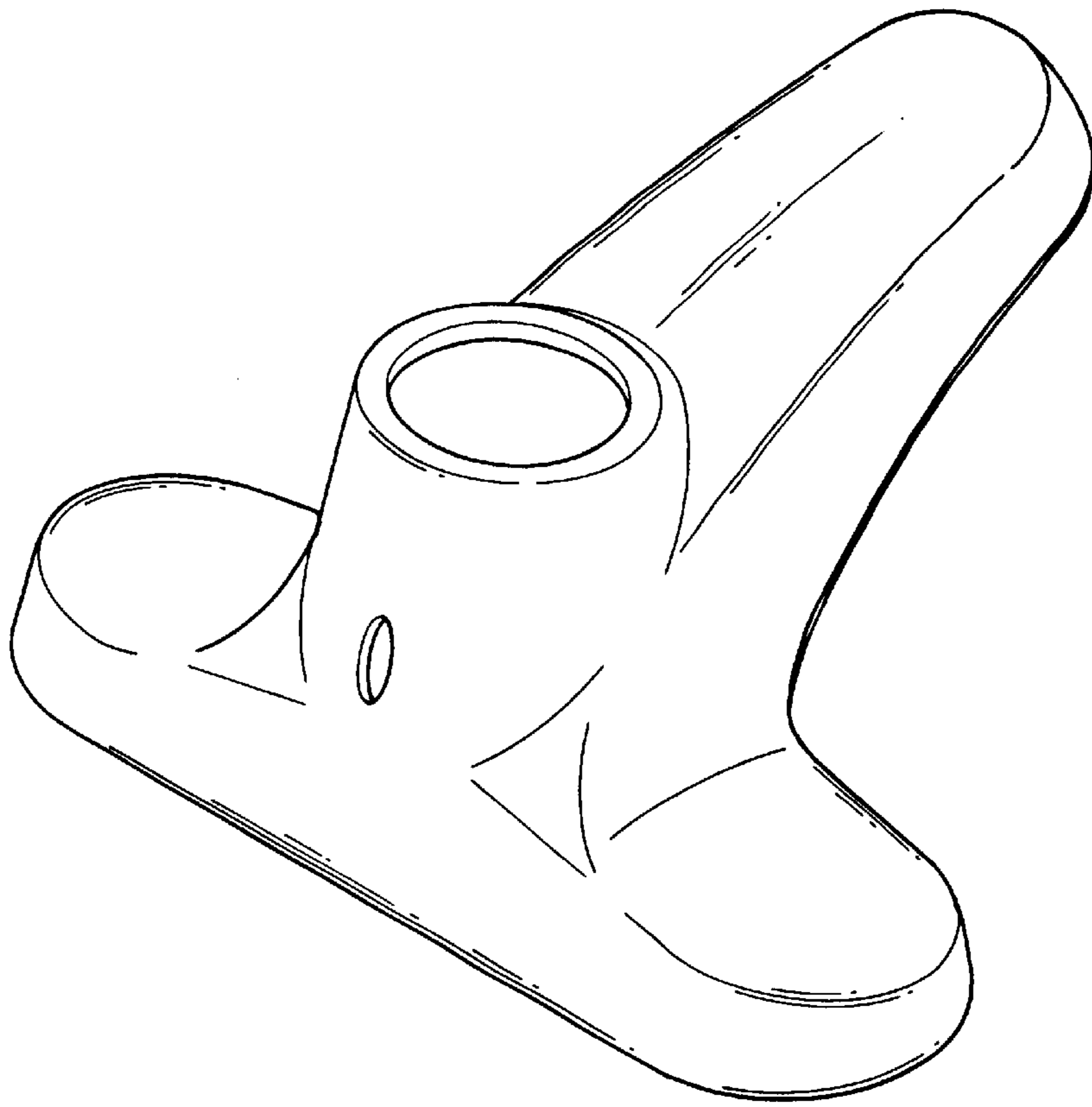

FIG · 1

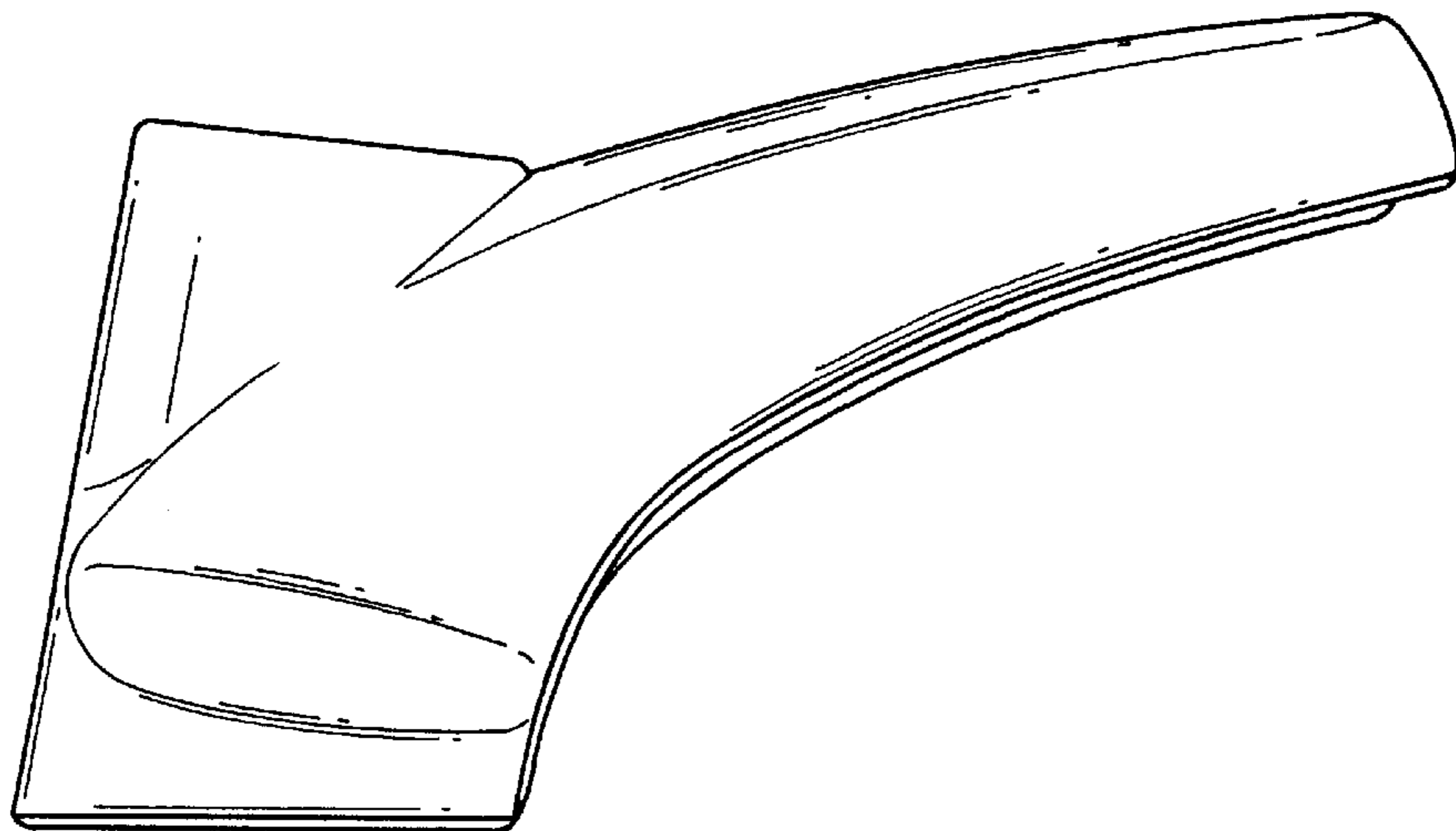

FIG · 4

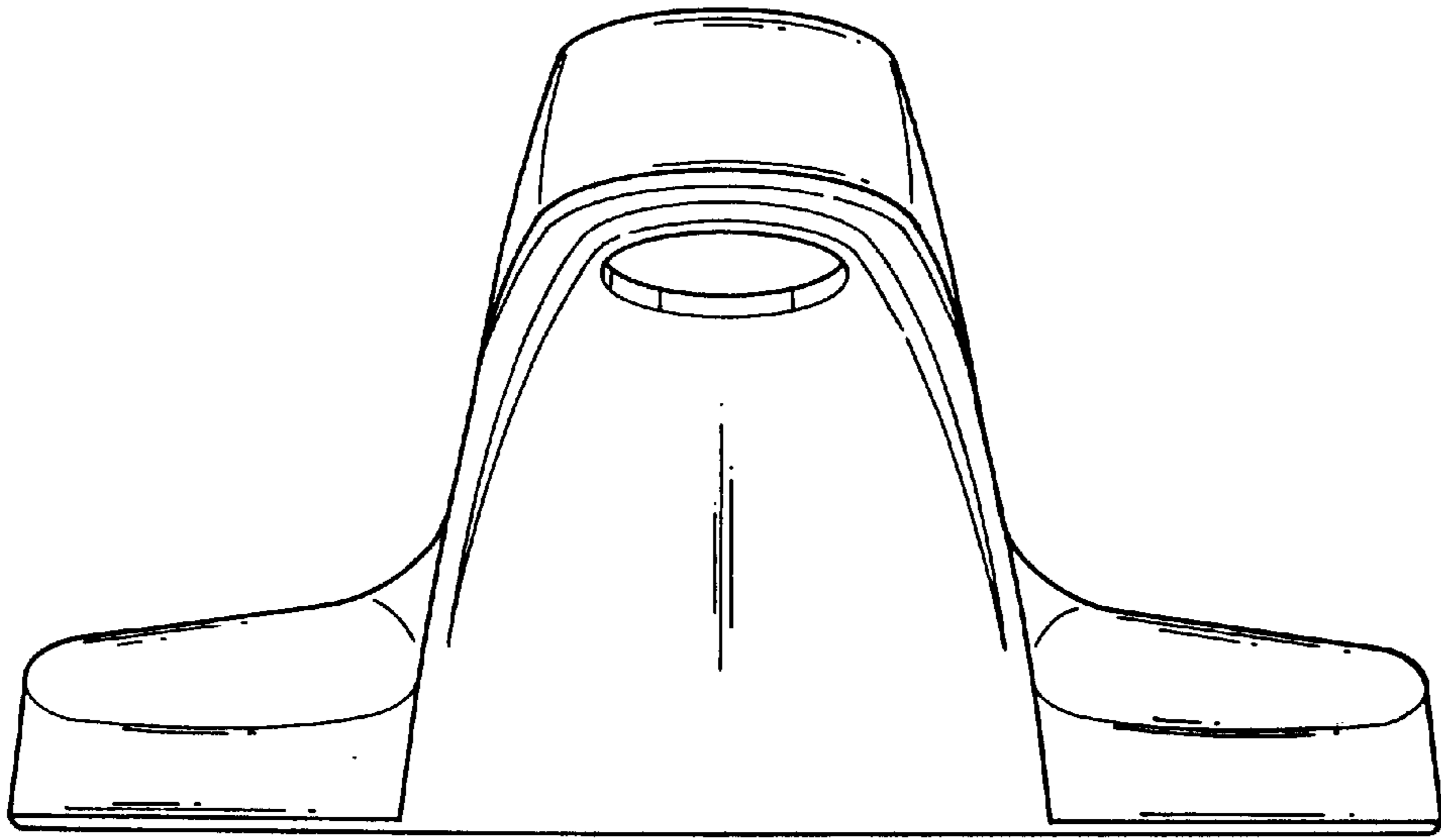

FIG · 2

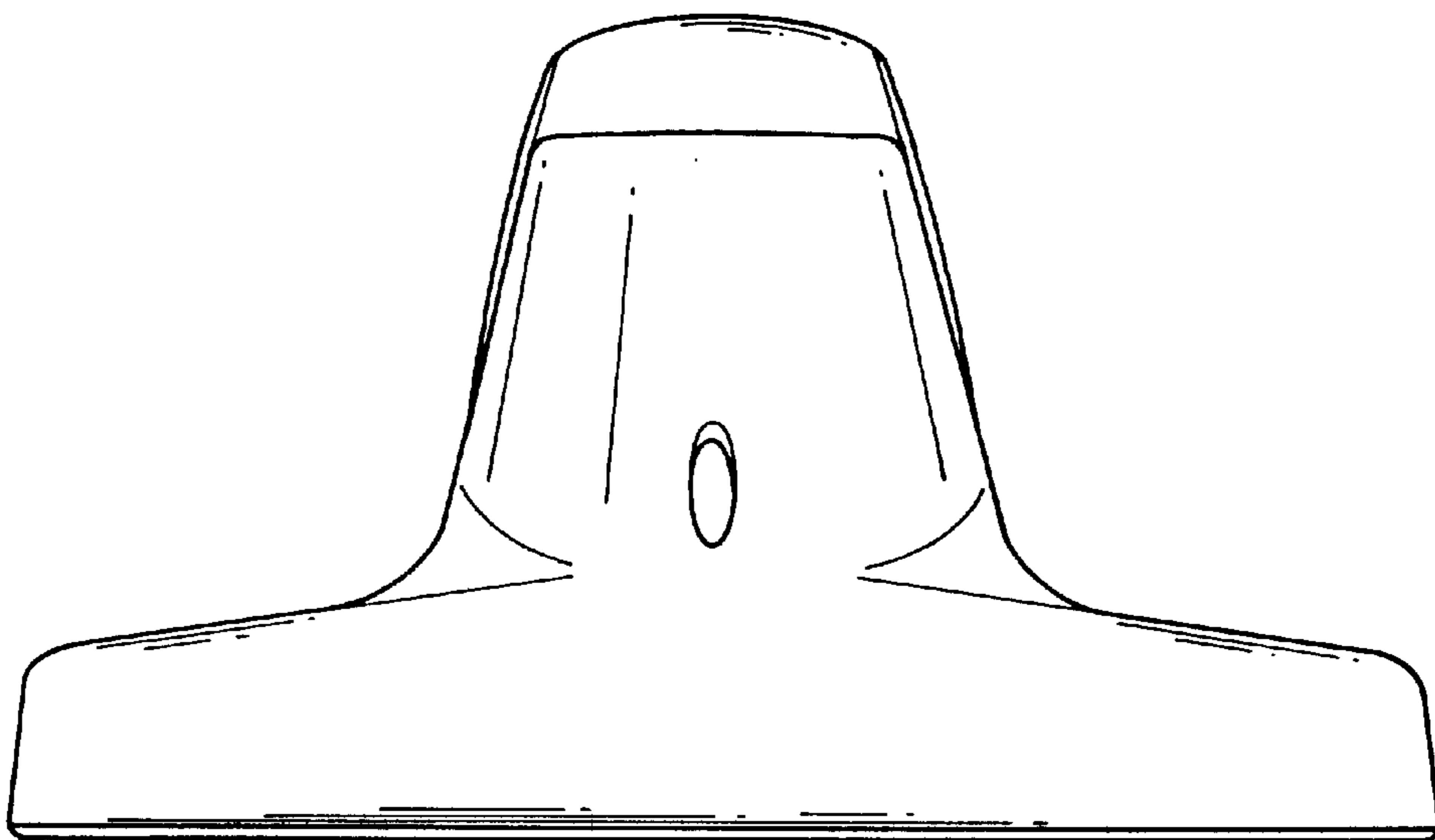

FIG · 3

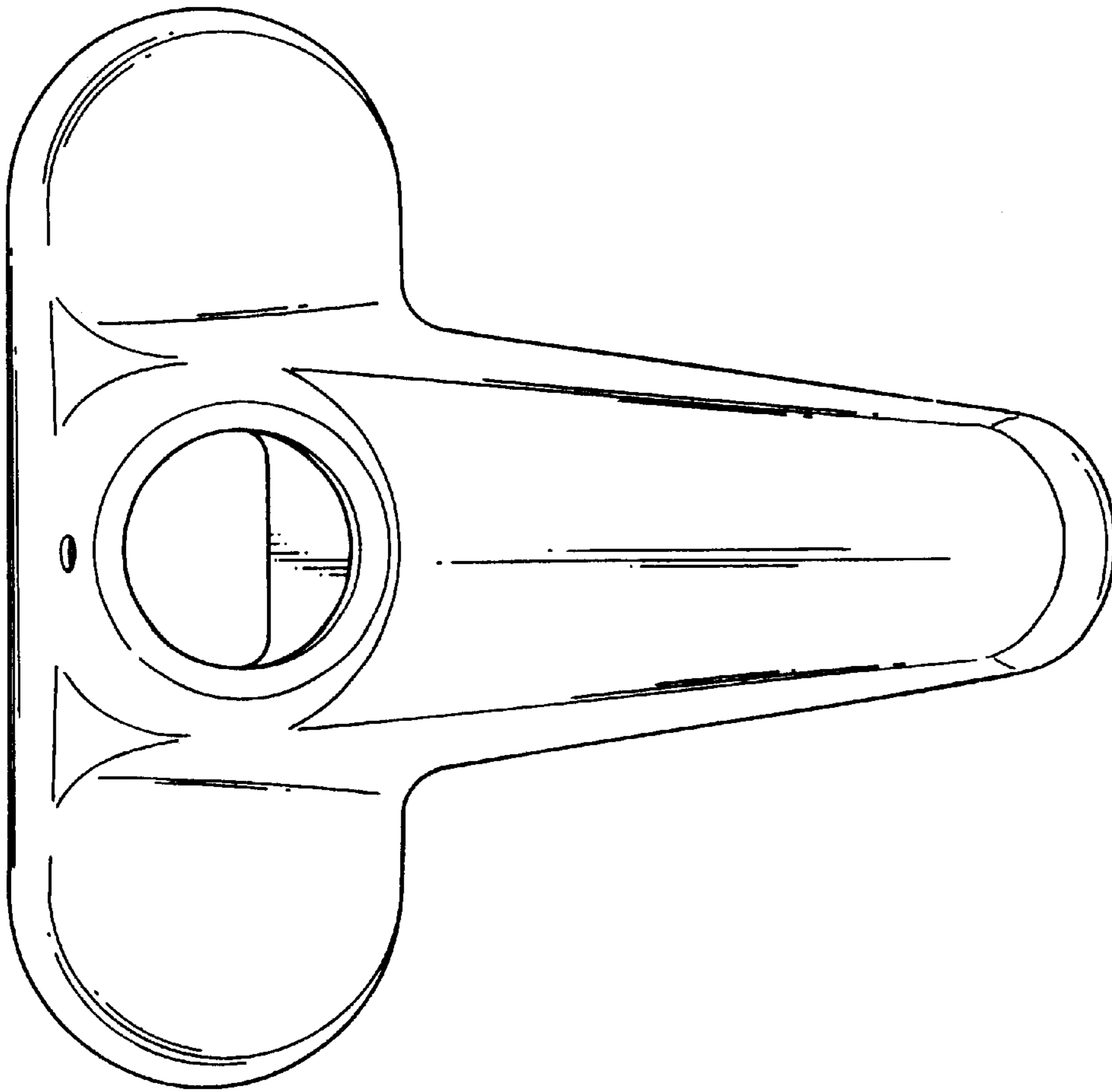

FIG. 5

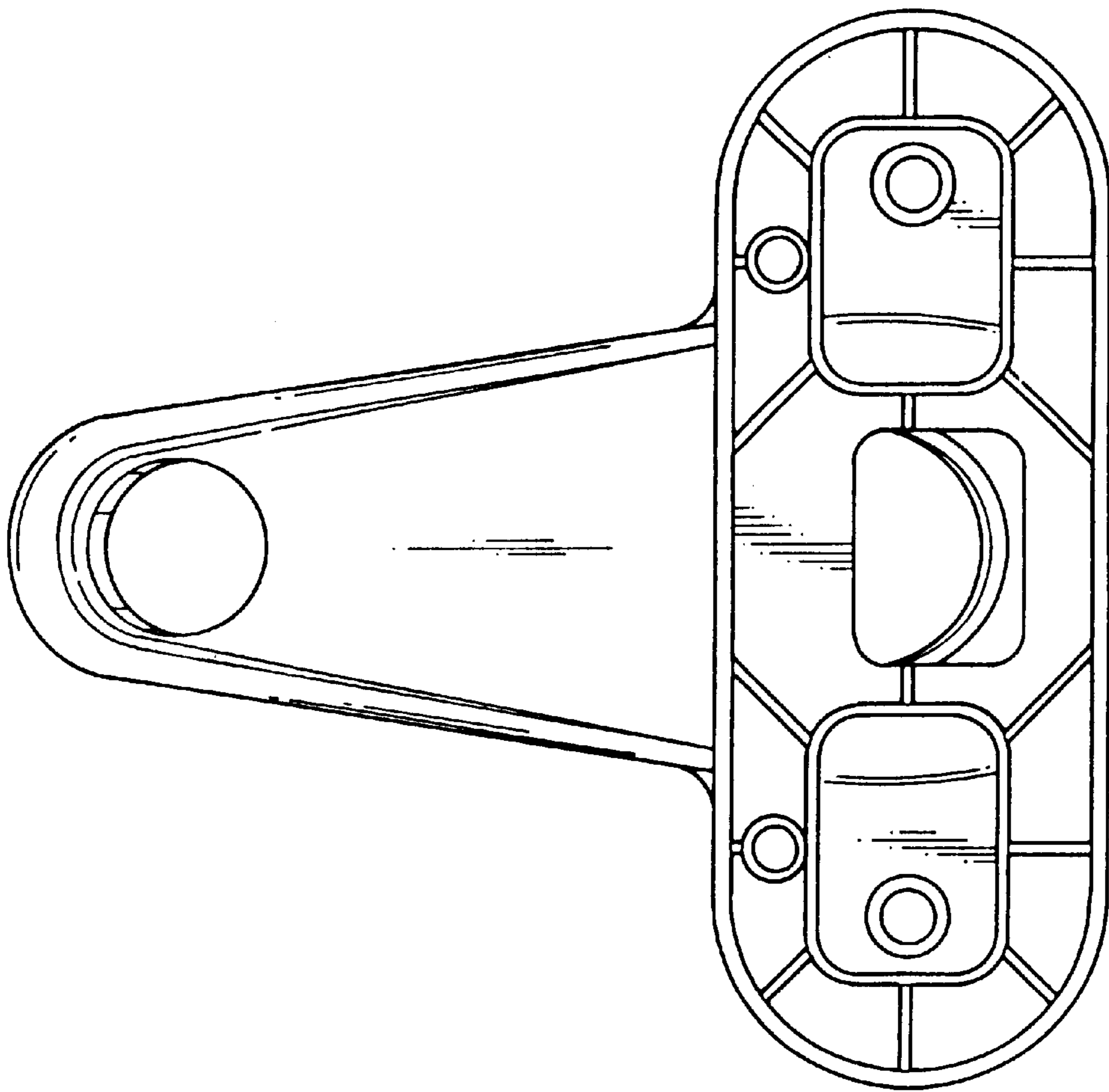

FIG. 6