



US00D463784S

(12) **United States Design Patent**
Taylor et al.

(10) **Patent No.: US D463,784 S**

(45) **Date of Patent: ** Oct. 1, 2002**

(54) **COMMUNICATION DEVICE**

D443,603 S * 6/2001 Taylor et al. D14/206

(75) Inventors: **Terrance N. Taylor**, Lake Geneva, WI (US); **David S. Weisz**, Kildeer, IL (US); **Connie Kus**, Palatine, IL (US); **Luigi Flori**, Wauconda, IL (US); **Kelly Ferguson**, Lake in the Hills, IL (US); **John Hartman**, Chicago, IL (US)

* cited by examiner

Primary Examiner—Paula A. Mortimer
(74) *Attorney, Agent, or Firm*—Randall S. Vaas

(73) Assignee: **Motorola, Inc.**, Schaumburg, IL (US)

(57) **CLAIM**

The ornamental design for a communication device, as shown and described.

(**) Term: **14 Years**

DESCRIPTION

(21) Appl. No.: **29/145,228**

FIG. 1 is a top, front and left side perspective view of a communication device, the broken lines to illustrate a first environment for the design and forming no part of the claimed design;

(22) Filed: **Jul. 18, 2001**

(51) **LOC (7) Cl.** **14-01**

(52) **U.S. Cl.** **D14/206**

(58) **Field of Search** D14/205, 206, D14/223, 137, 138, 192, 249; 181/129, 130; 379/430, 431; 381/26, 92, 95, 369, 370, 376, 377, 118, 74, 72

FIG. 2 is a left side elevation view of the design of FIG. 1; FIG. 3 is a front elevation view of the design of FIG. 1; FIG. 4 is a right side elevation view of the design of FIG. 1; FIG. 5 is a rear elevation view of the design of FIG. 1; FIG. 6 is a bottom plan view of the design of FIG. 1; FIG. 7 is a top plan view of the design of FIG. 1; and, FIG. 8 is a top, front and left side perspective view of the communication device, the broken lines to illustrate a second environment for the design and forming no part of the claimed design.

(56) **References Cited**

U.S. PATENT DOCUMENTS

- D353,818 S * 12/1994 Nakamura D14/205
- D357,477 S * 4/1995 Mueller et al. D14/206
- 5,751,825 A * 5/1998 Myers et al. 381/118
- 5,970,155 A * 10/1999 Leppalahti 381/72

The broken line matter in all figures is for illustrative purposes only and forms no part of the claimed design.

1 Claim, 5 Drawing Sheets

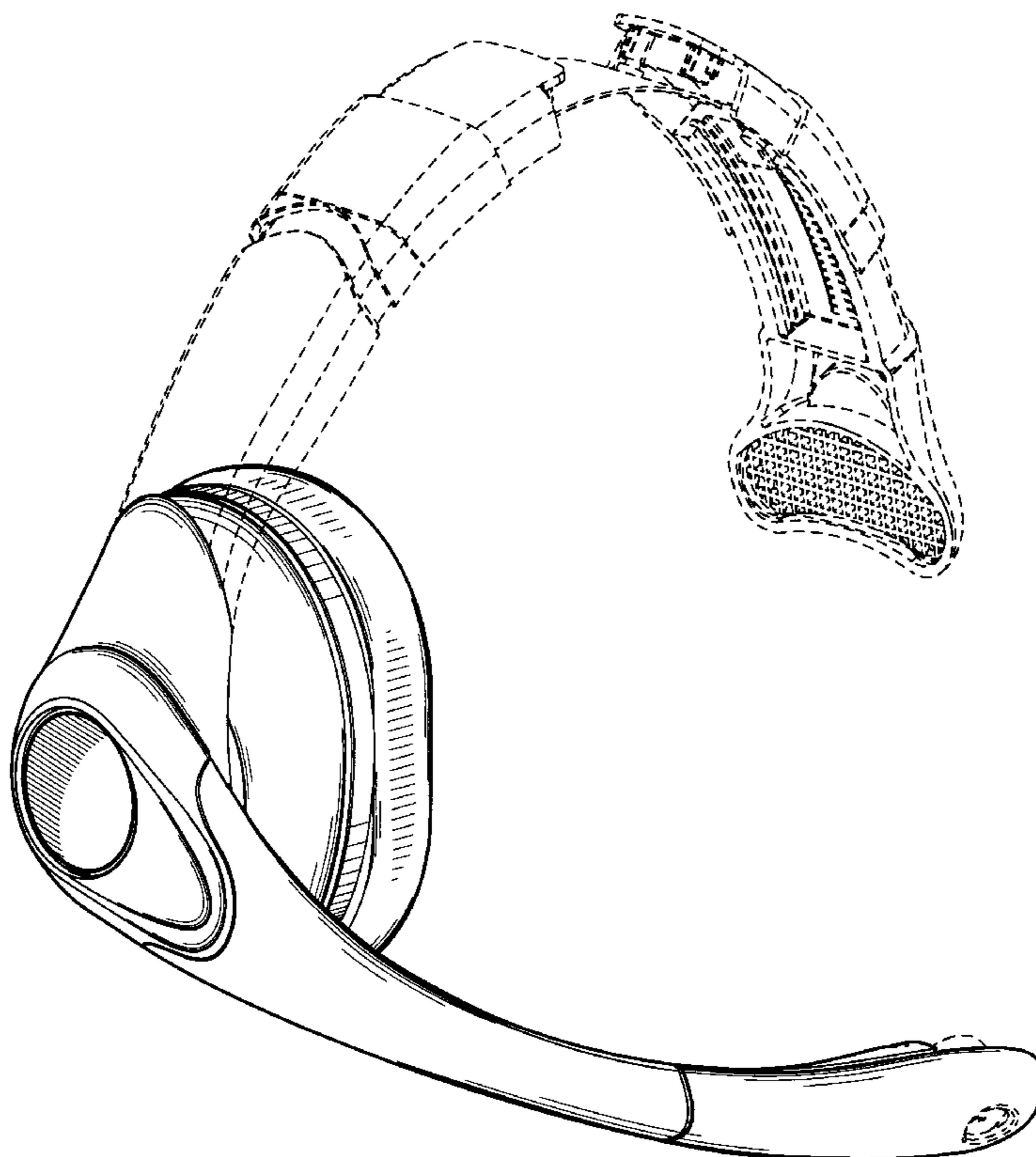

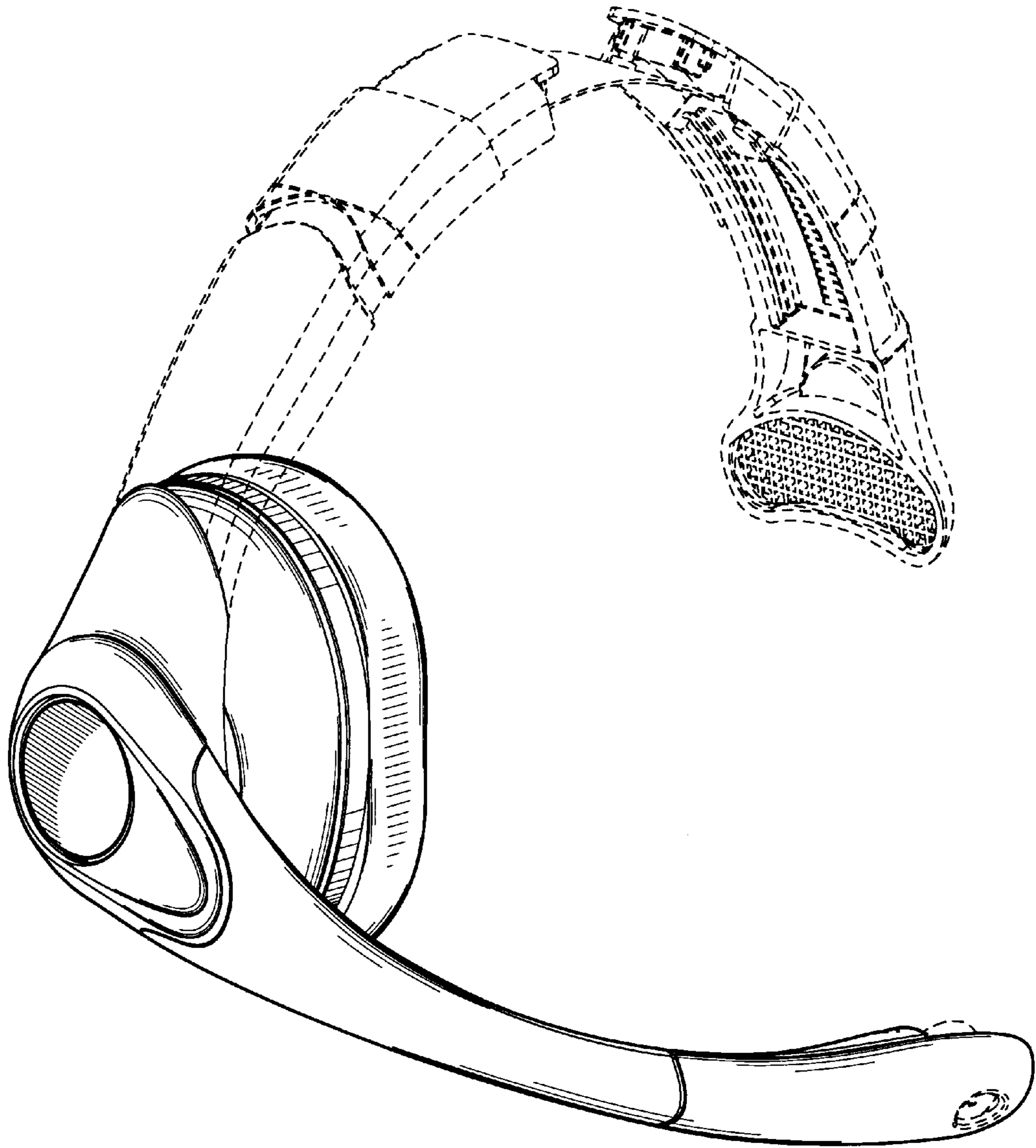

FIG. 1

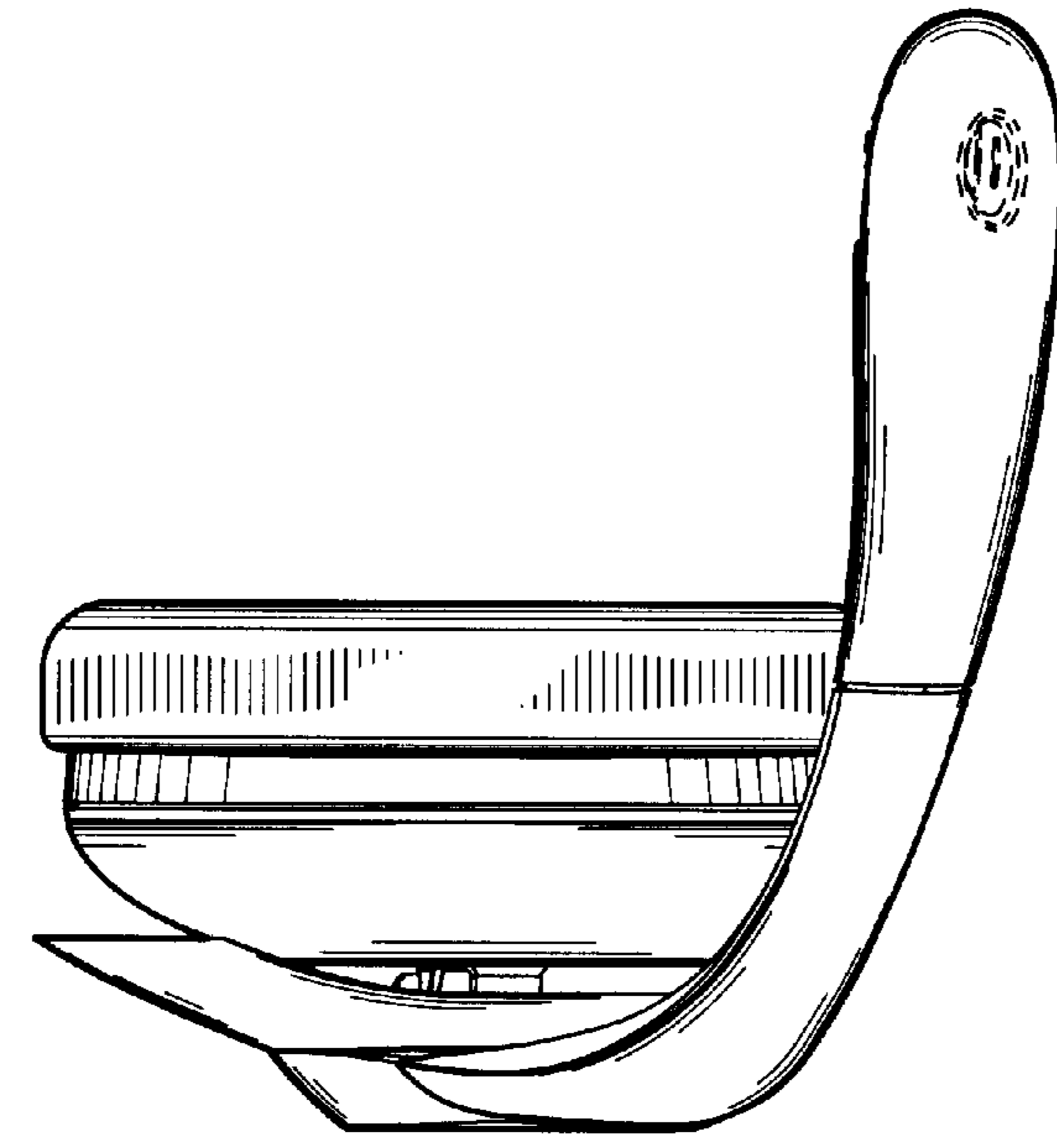

FIG. 3

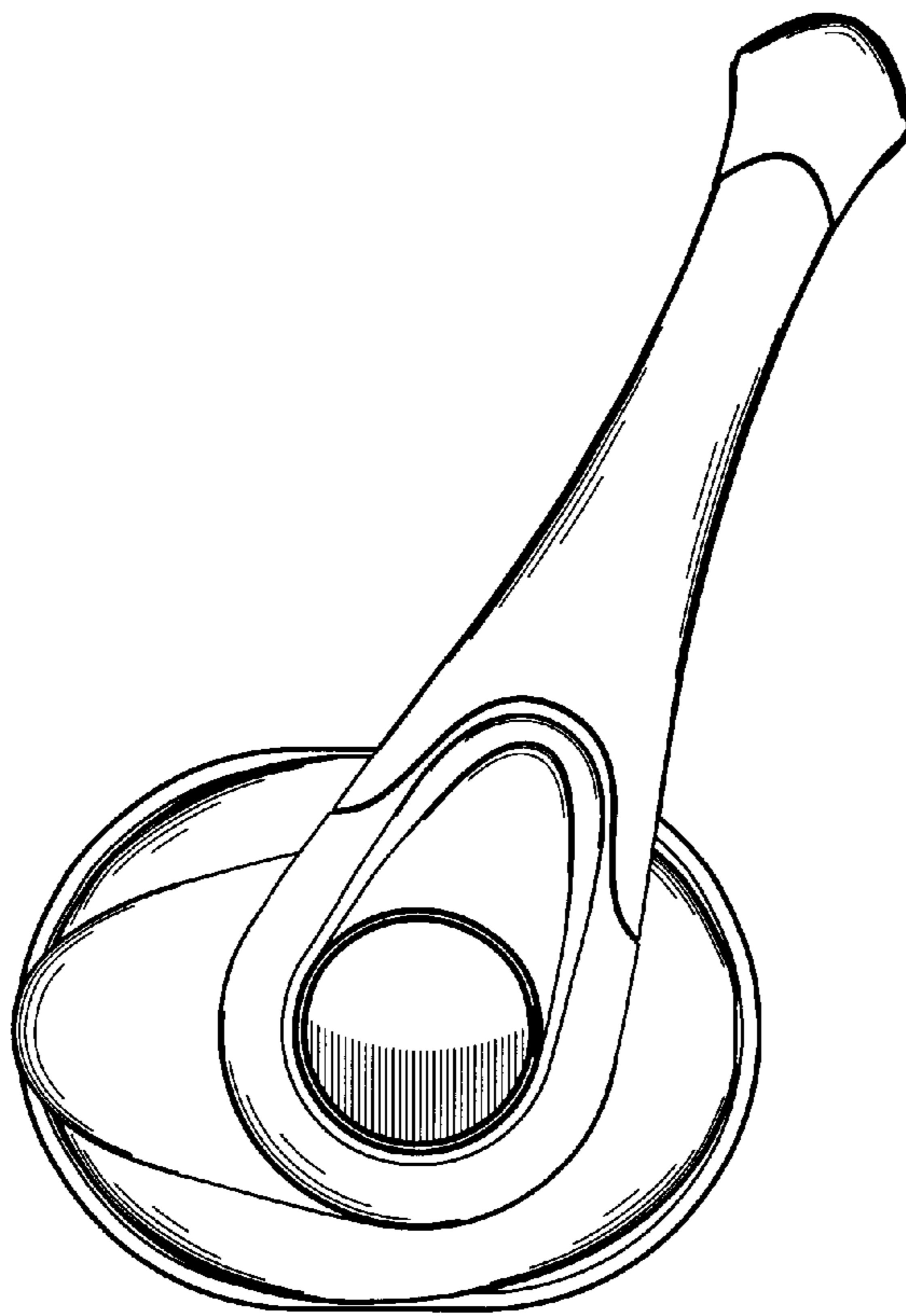

FIG. 2

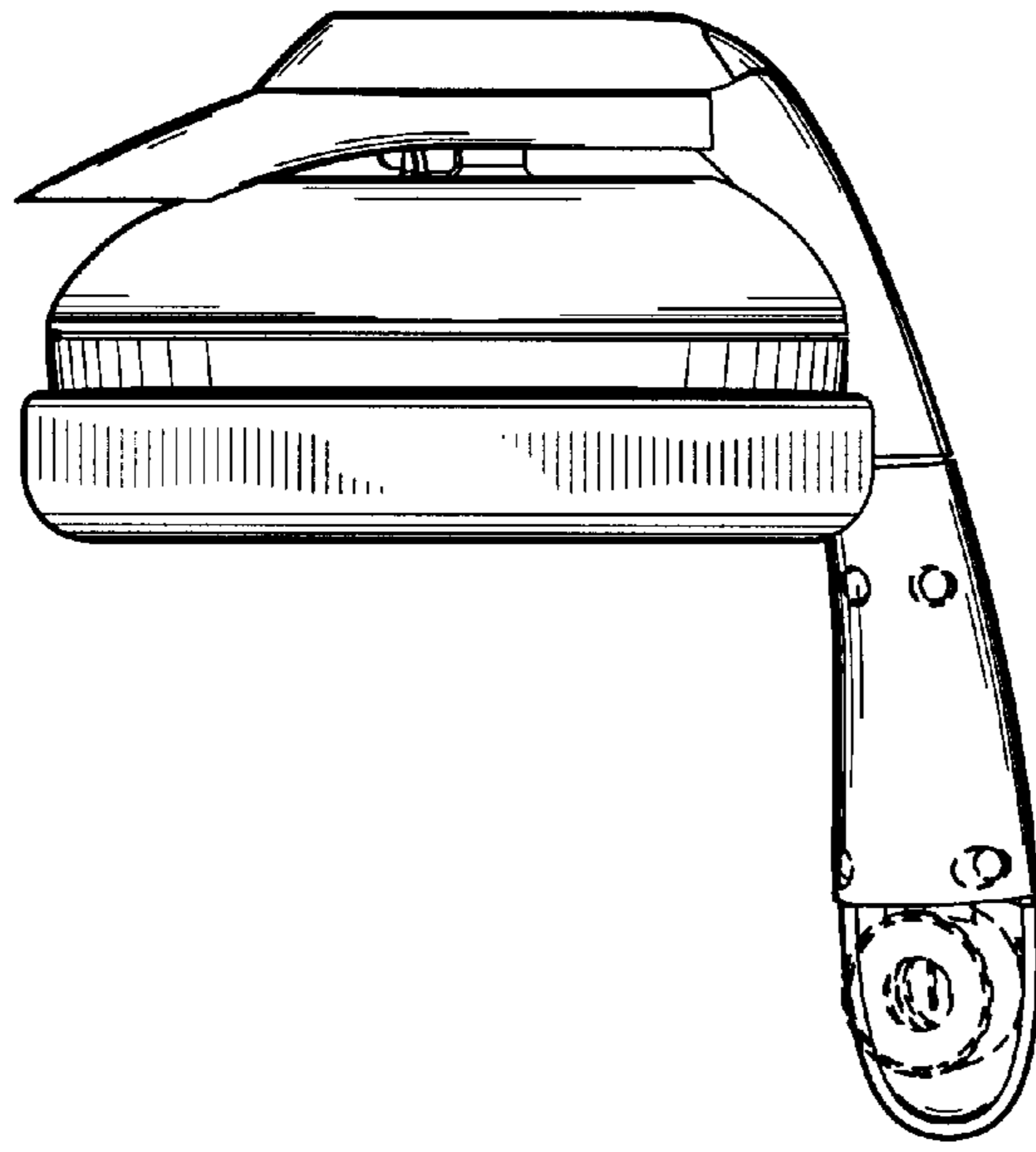

FIG. 5

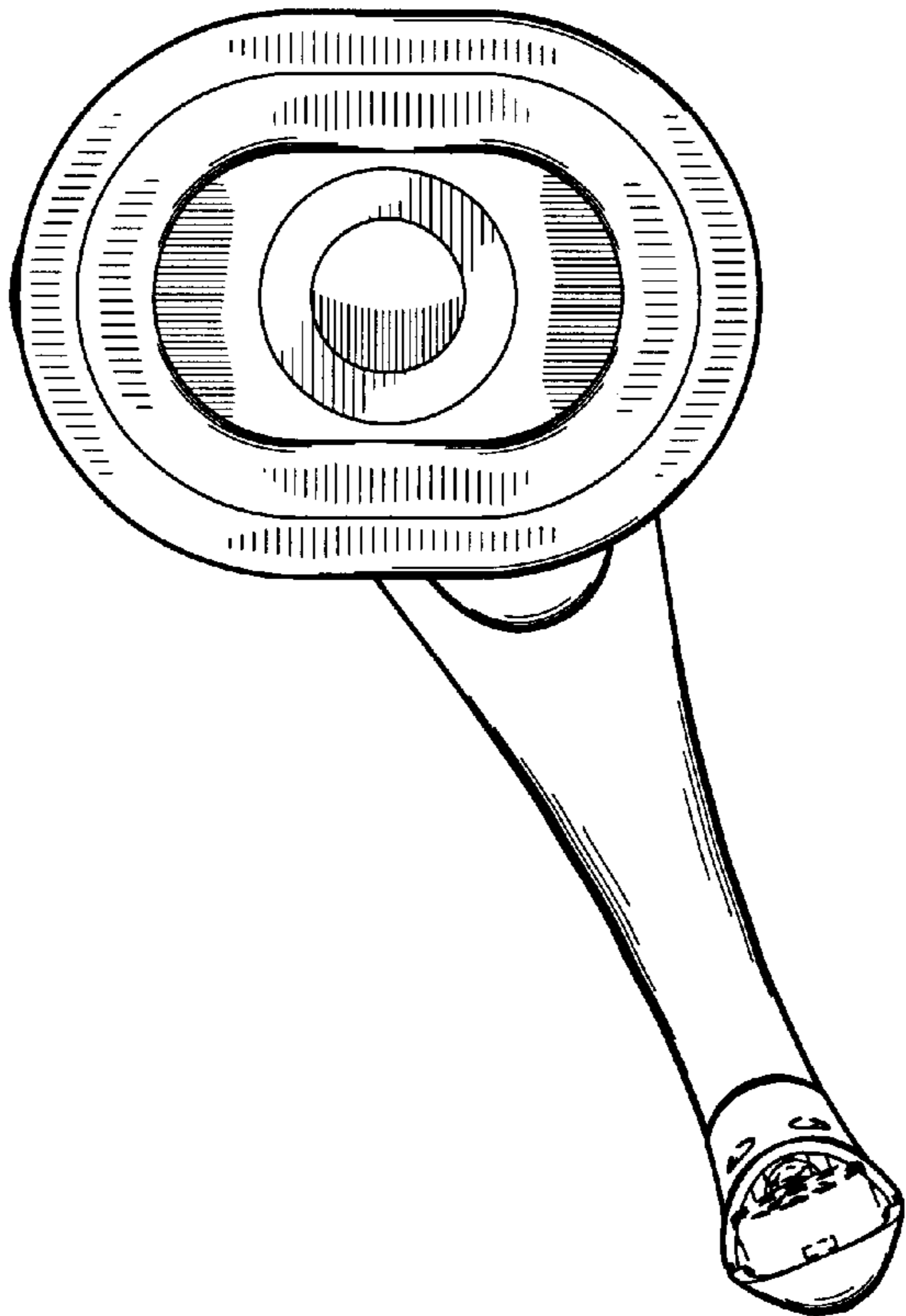

FIG. 4

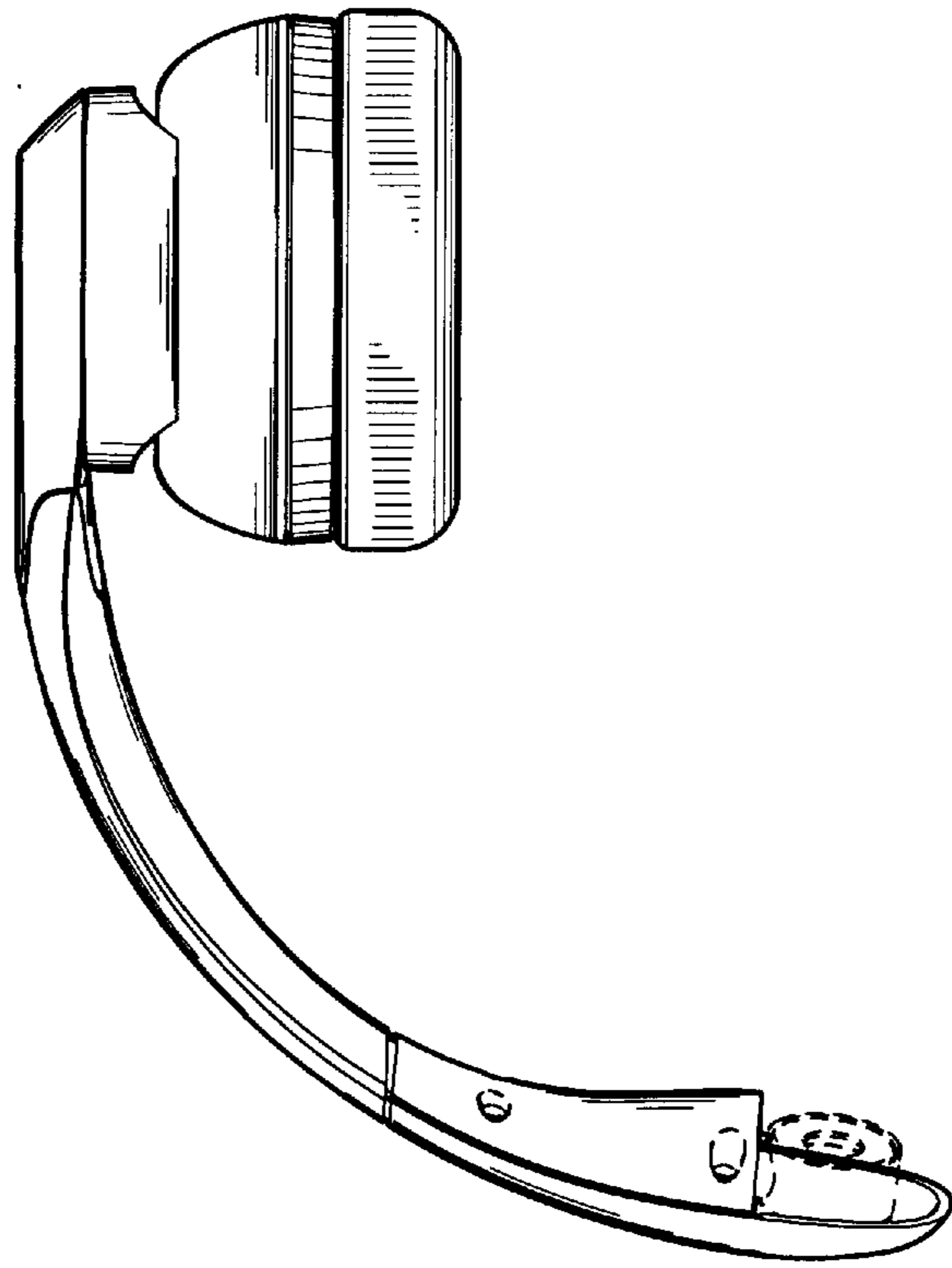

FIG. 6

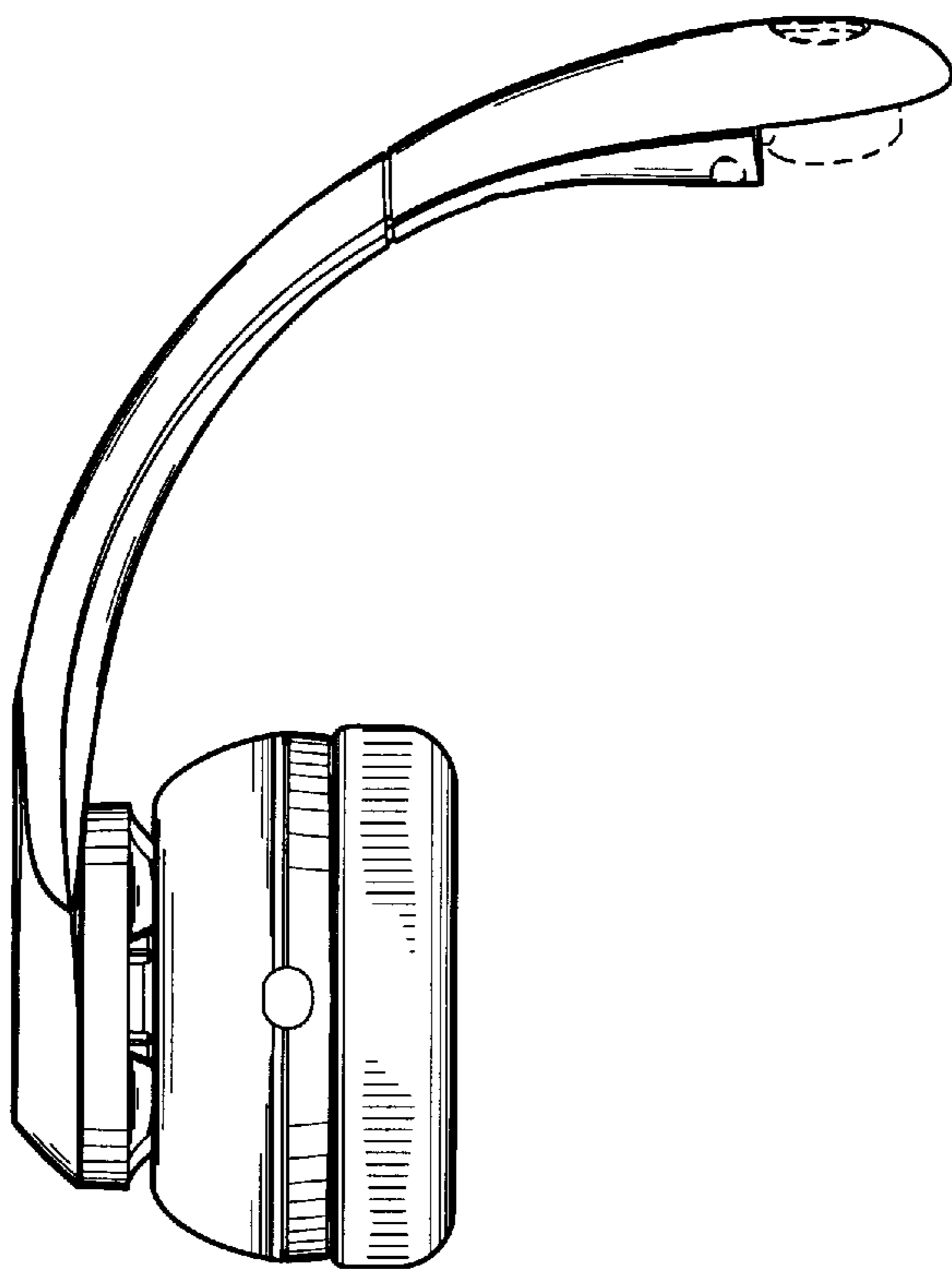

FIG. 7

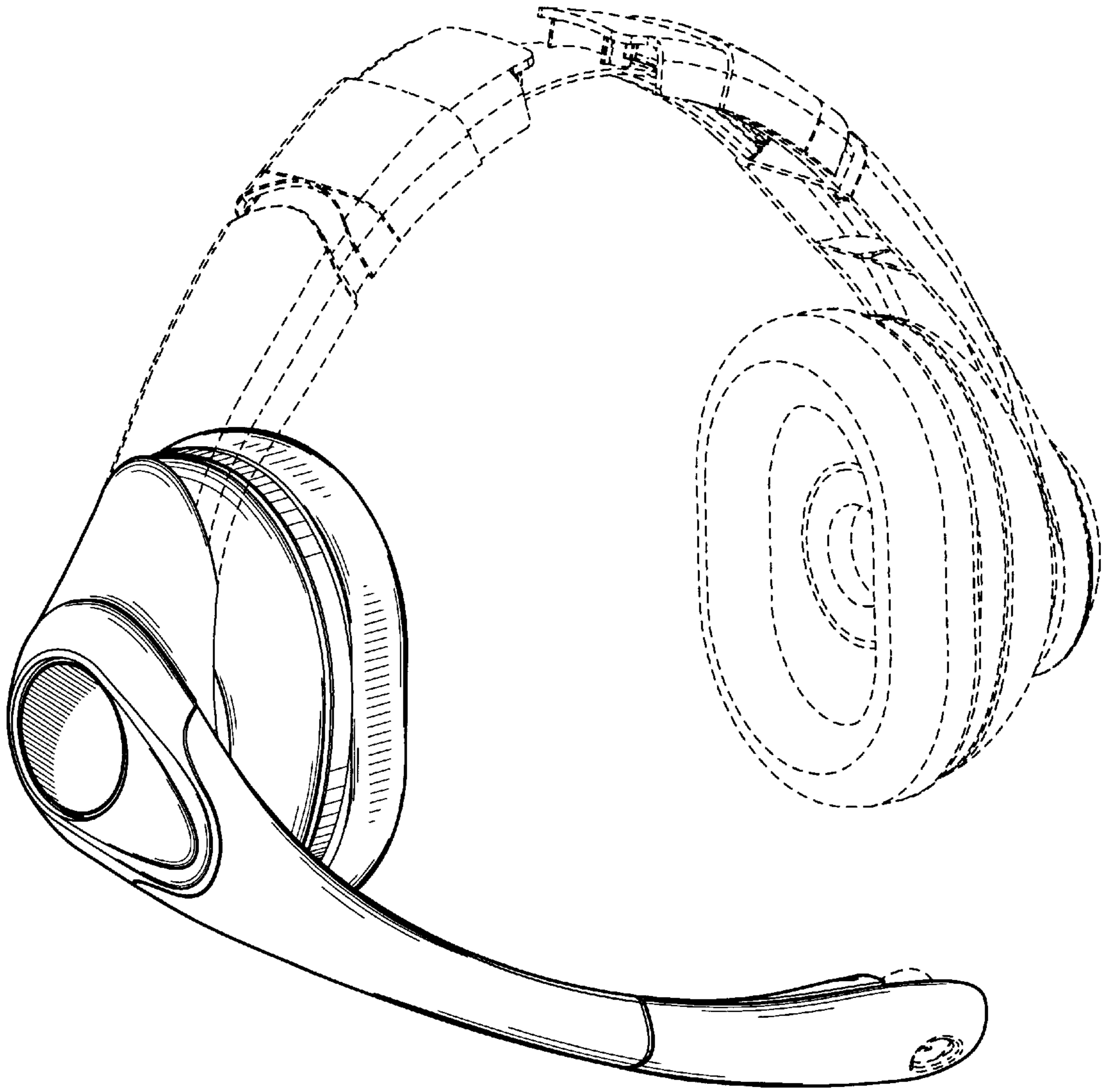

FIG. 8