



US00D463707S

(12) **United States Design Patent**  
**Bossler**

(10) **Patent No.:** **US D463,707 S**

(45) **Date of Patent:** **\*\* Oct. 1, 2002**

(54) **PORTABLE ROUND BARBECUE GRILL**

(75) Inventor: **Martin C. Bossler**, Spring Grove, IL (US)

(73) Assignee: **Uniflame Corporation**, Zion, IL (US)

(\*\*) Term: **14 Years**

(21) Appl. No.: **29/146,522**

(22) Filed: **Aug. 10, 2001**

(51) **LOC (7) Cl.** ..... **07-02**

(52) **U.S. Cl.** ..... **D7/332**

(58) **Field of Search** ..... D7/332, 334-337, D7/402-404; 126/25 R, 25 A, 25 AA, 9 R, 9 B, 29-30, 41 R; 99/421 R, 444

(56) **References Cited**

**U.S. PATENT DOCUMENTS**

2,641,243 A	6/1953	Goss	126/25
3,051,159 A	8/1962	Hardy	126/25
D284,929 S	8/1986	Schlosser et al.	D7/332
D293,191 S	* 12/1987	Stephen et al.	D7/332
4,836,179 A	* 6/1989	Schlosser et al.	126/25 R
5,159,917 A	* 11/1992	Archer et al.	126/25 R

5,355,558 A	10/1994	Vetrtanen	16/360
D352,865 S	* 11/1994	Pai	D7/337
D355,566 S	2/1995	Stephen et al.	D7/331
D385,147 S	* 10/1997	Fielding et al.	D7/332
D420,546 S	* 2/2000	Pai	D7/332
D427,840 S	* 7/2000	Pai	D7/332

\* cited by examiner

*Primary Examiner*—Ruth McInroy

(74) *Attorney, Agent, or Firm*—Greer, Burns & Crain, Ltd.

(57) **CLAIM**

The ornamental design for a portable round barbecue grill, as shown and described.

**DESCRIPTION**

FIG. 1 is a perspective view of a portable round barbecue grill showing my new design; FIG. 2 is a front view thereof; FIG. 3 is a right side view thereof; FIG. 4 is a top view thereof; FIG. 5 is a bottom view thereof; FIG. 6 is a left side view thereof; and, FIG. 7 is a rear view thereof.

**1 Claim, 2 Drawing Sheets**

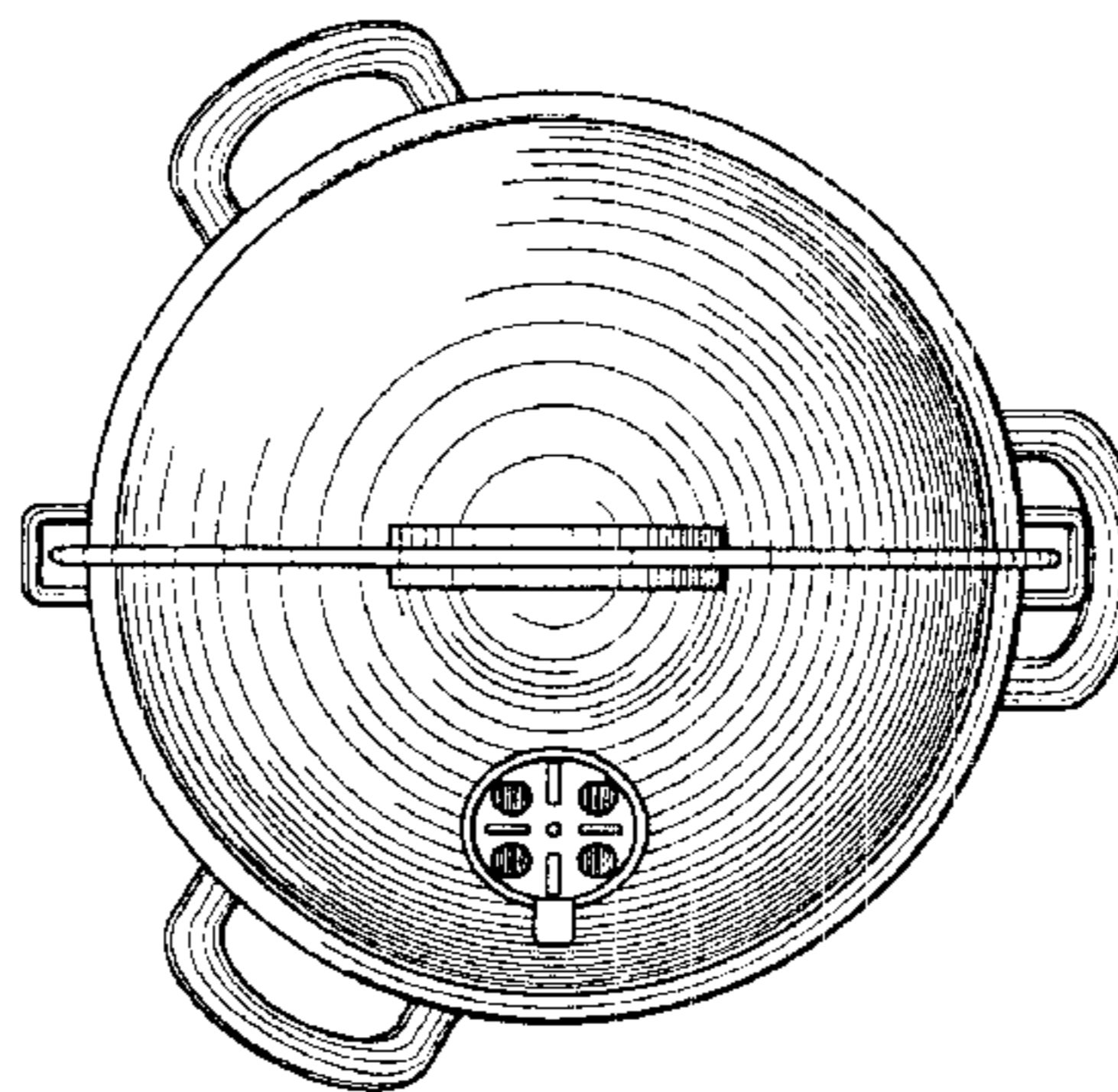
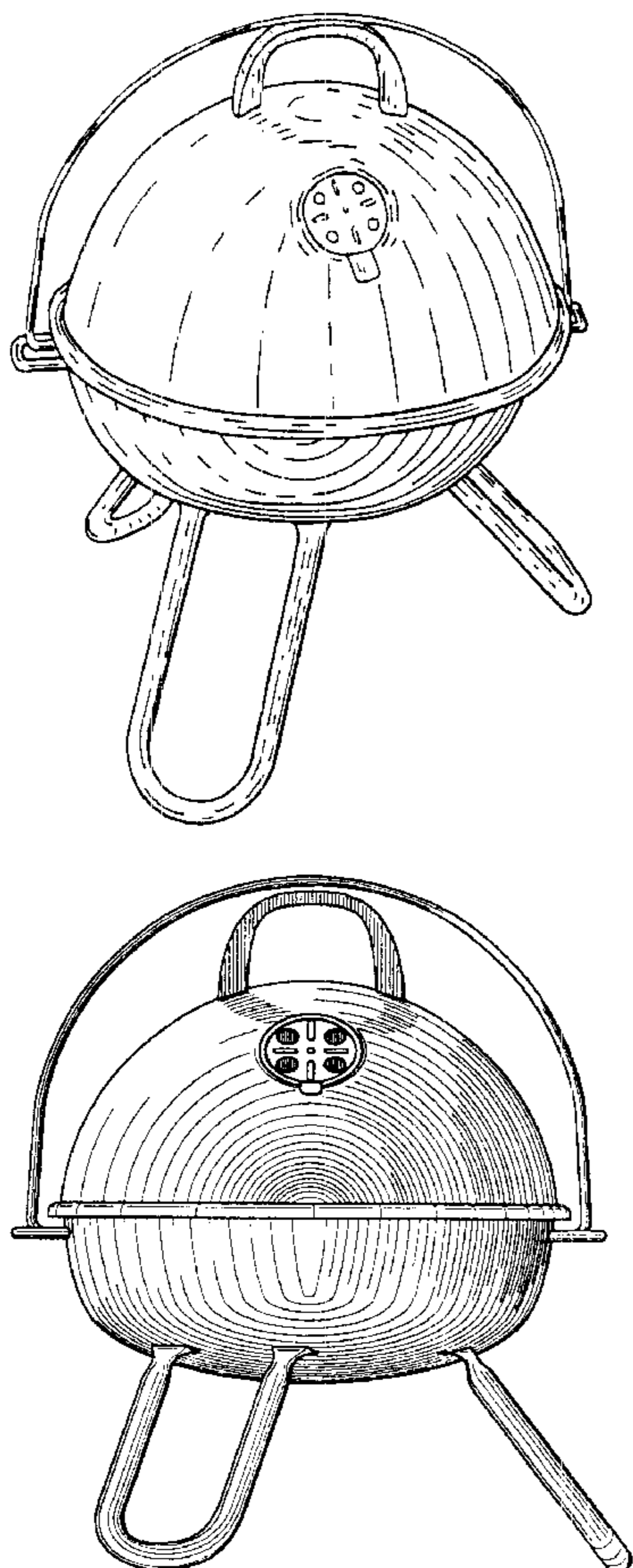

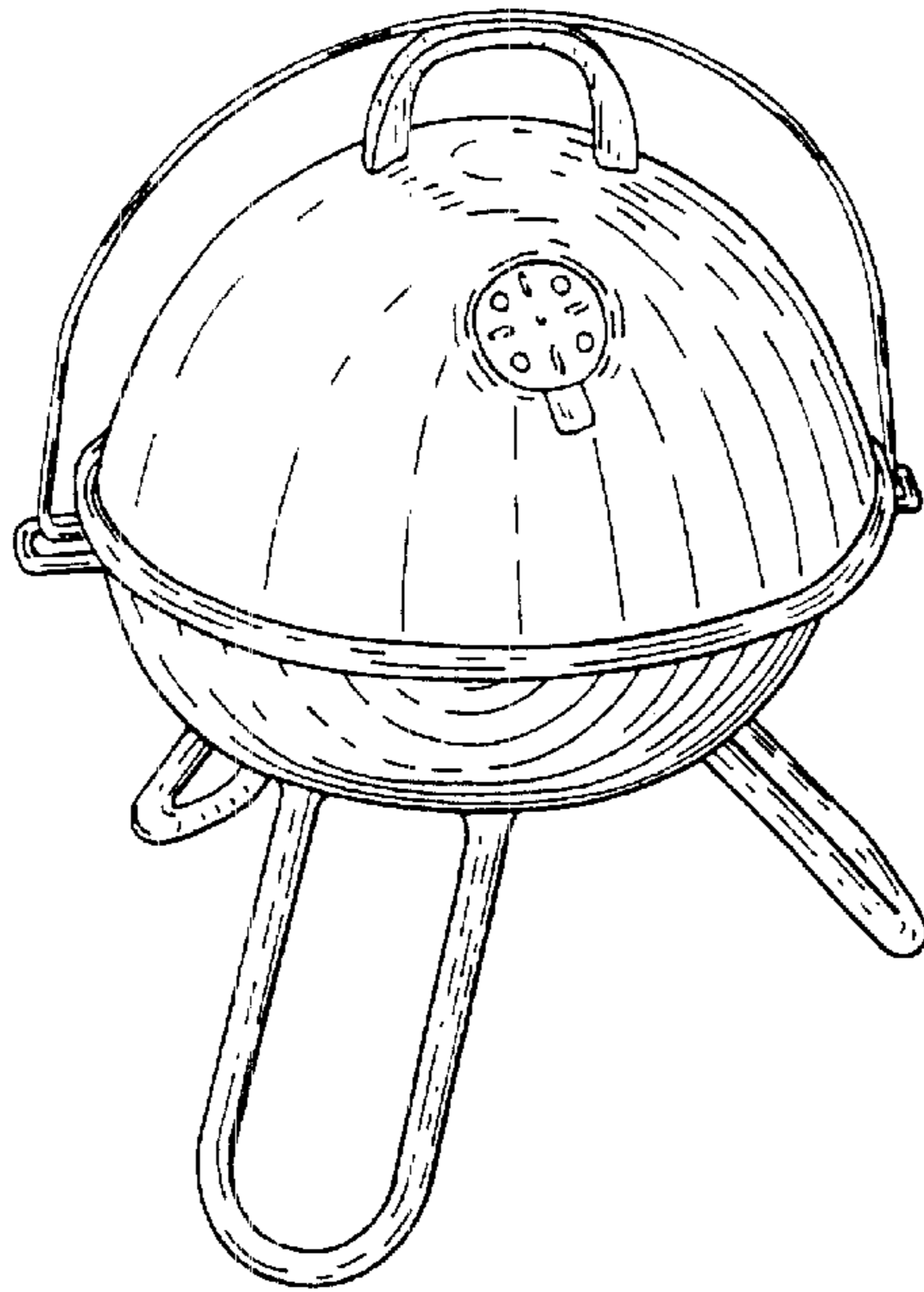

Fig.1

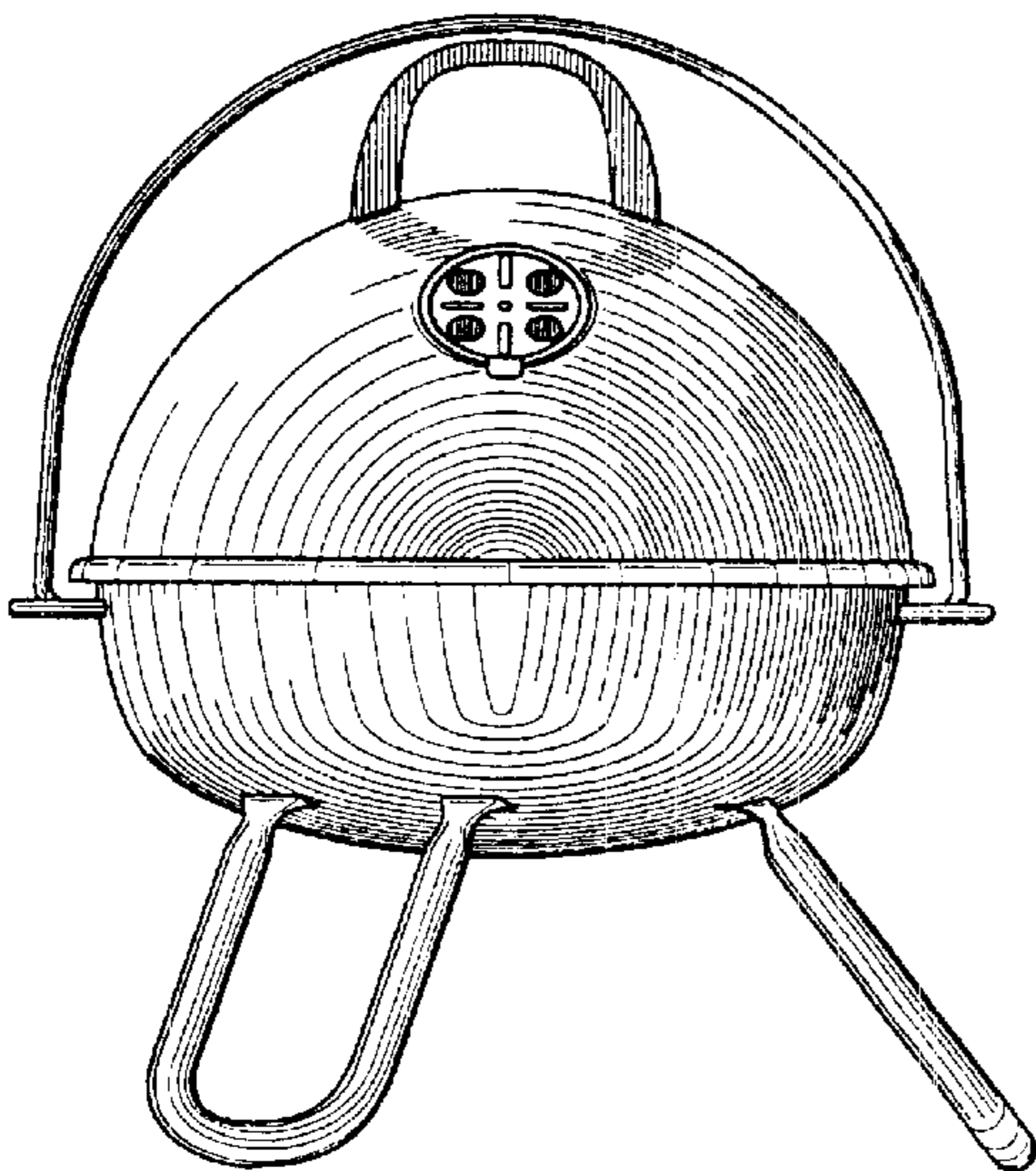

Fig.2

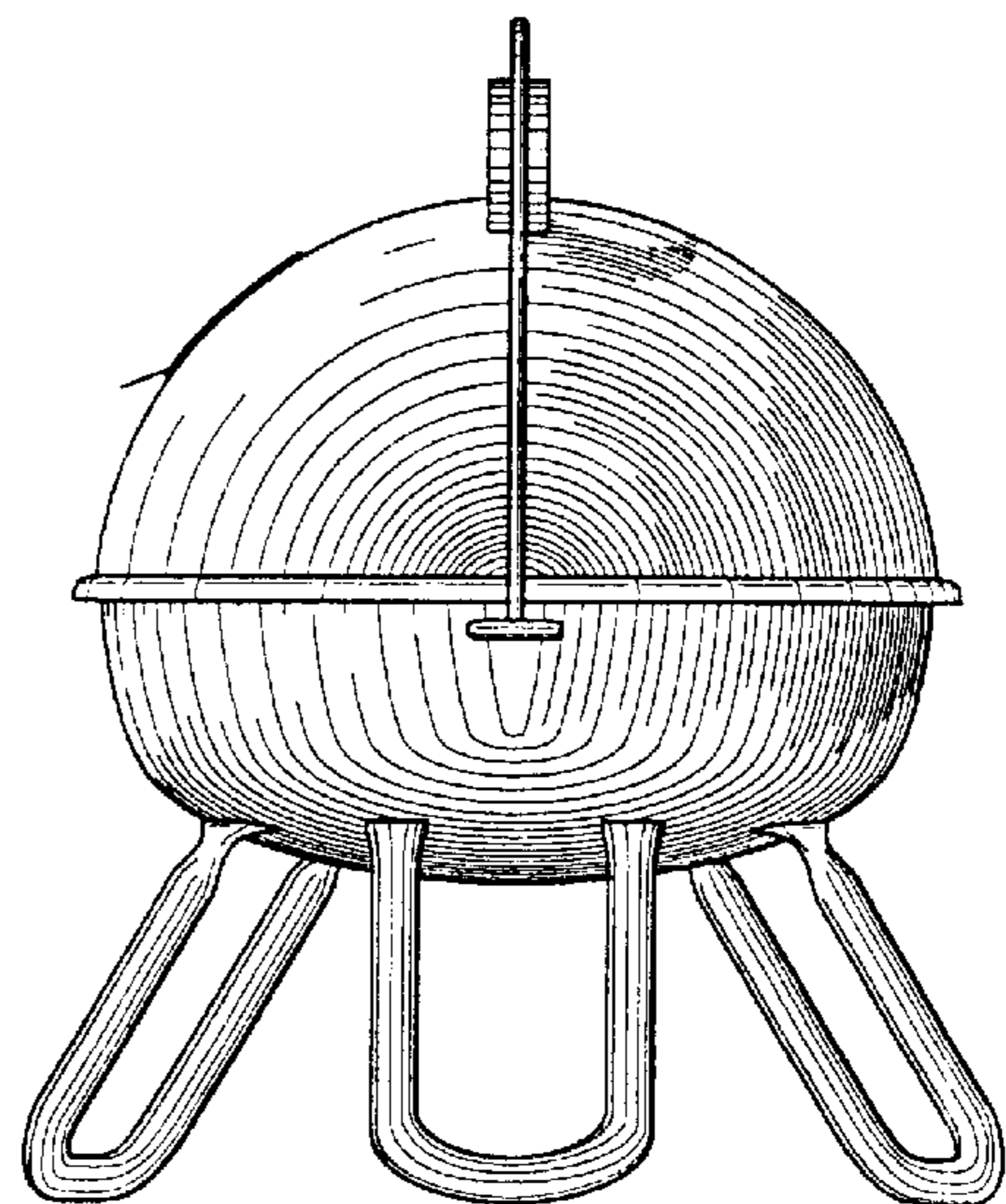

Fig.3



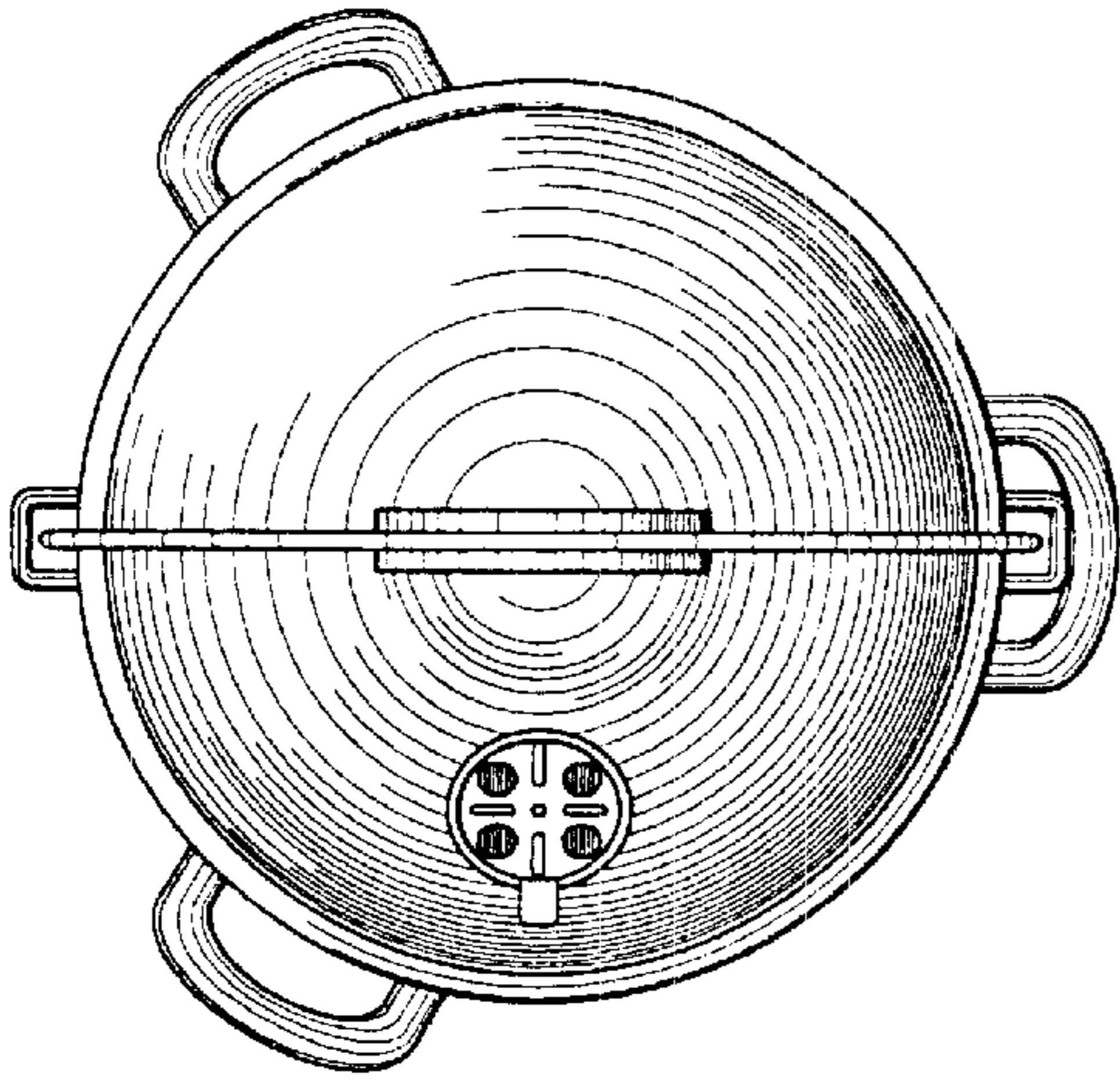

Fig. 4

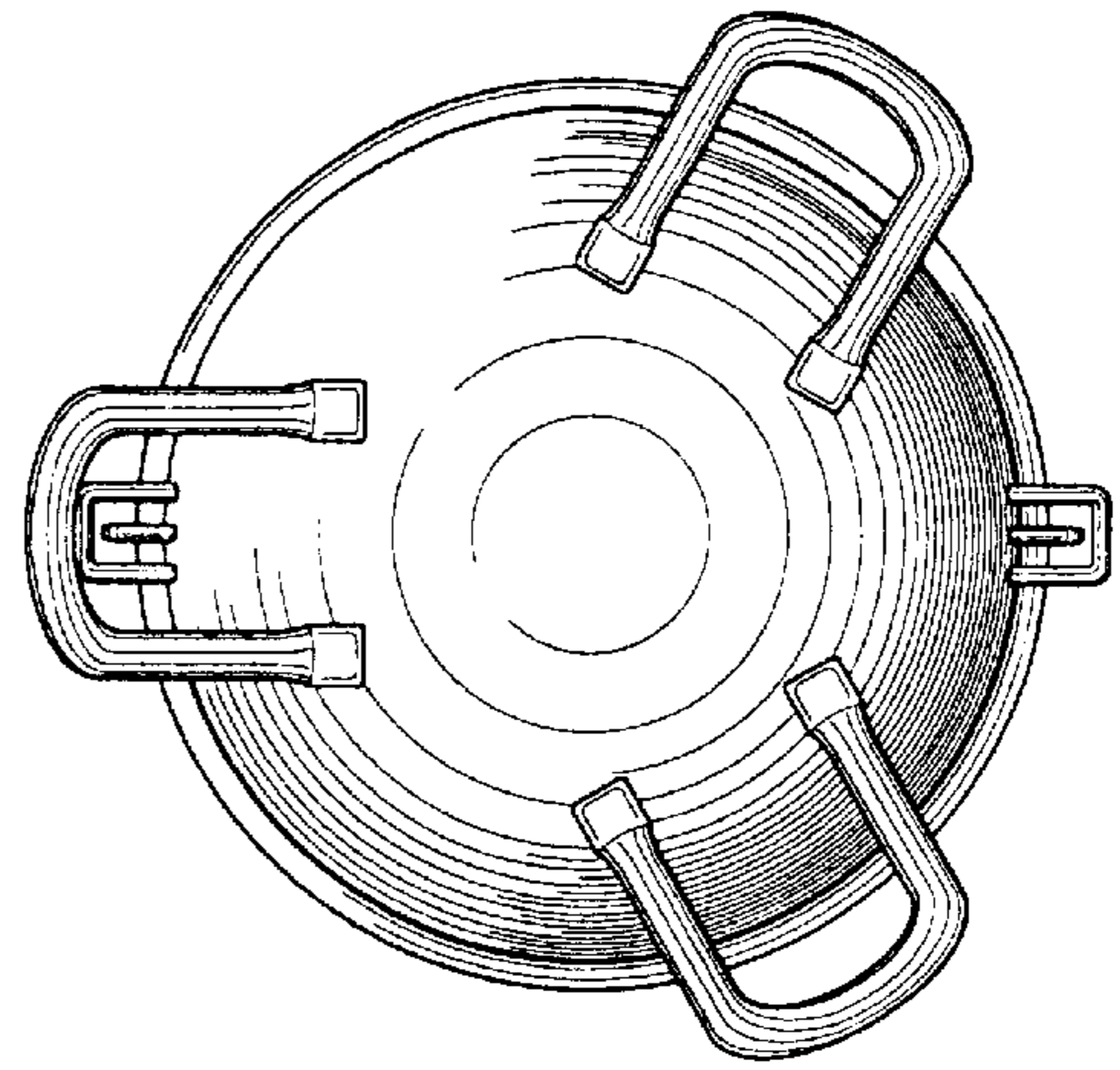

Fig. 5

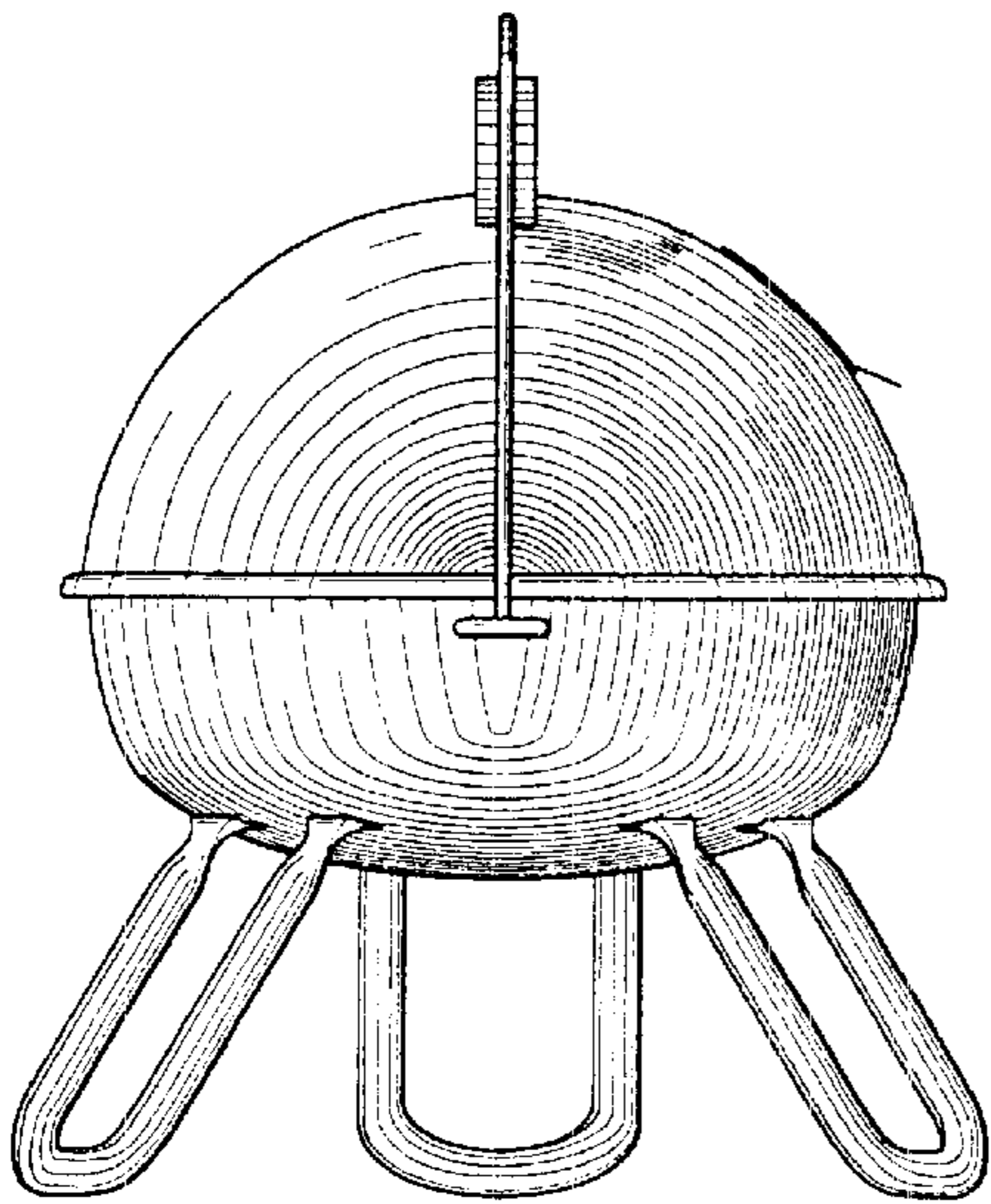

Fig. 6

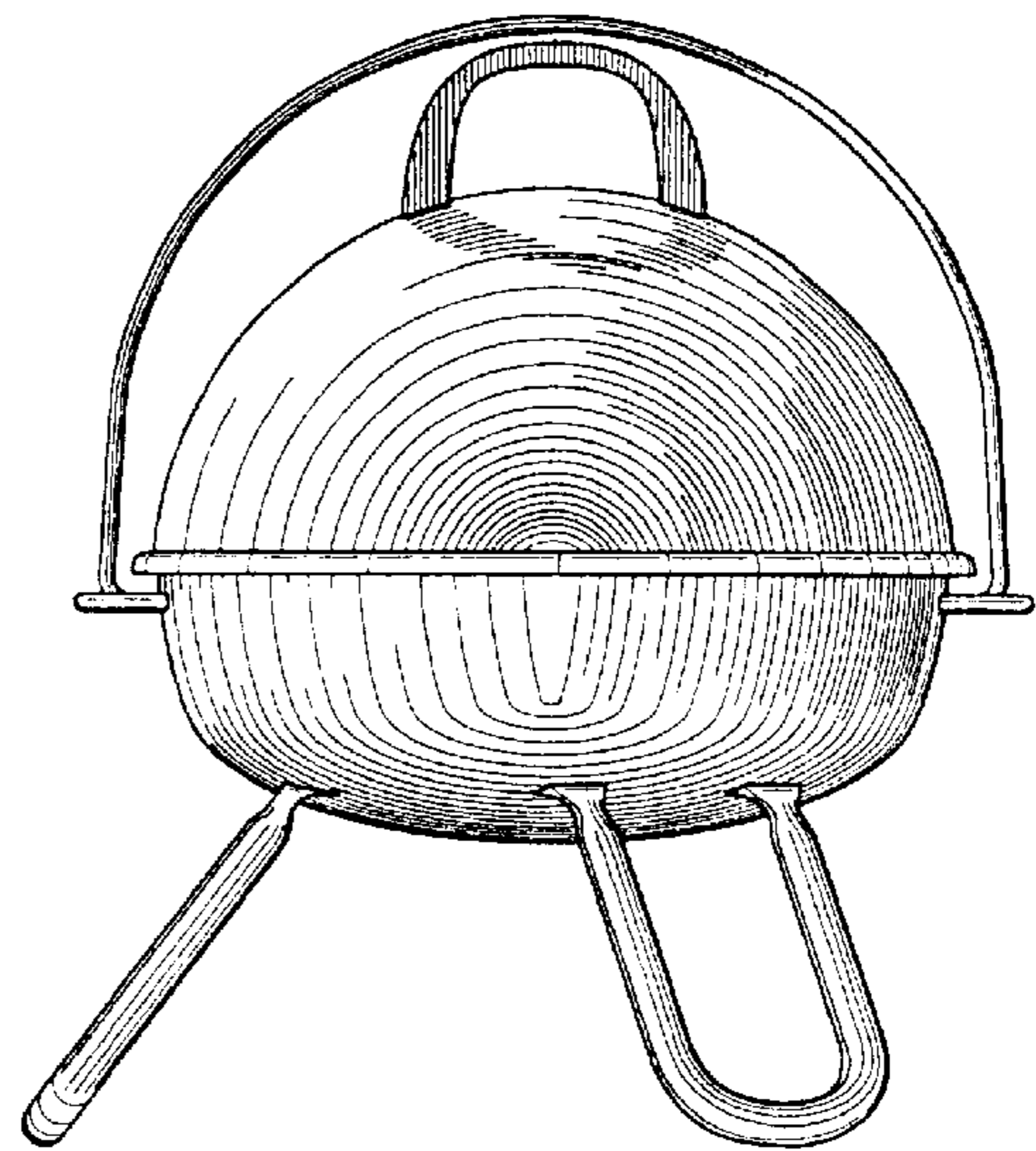

Fig. 7