



US00D463702S

(12) **United States Design Patent**
Ku

(10) **Patent No.:** **US D463,702 S**

(45) **Date of Patent:** **** Oct. 1, 2002**

(54) **INFLATABLE MAT**

(76) **Inventor:** **Tun-Jen Ku**, 16, Kuo Chung 2nd Rd.,
Da-Li City, Taichung (TW)

(**) **Term:** **14 Years**

(21) **Appl. No.:** **29/144,195**

(22) **Filed:** **Jun. 25, 2001**

(51) **LOC (7) Cl.** **06-09**

(52) **U.S. Cl.** **D6/604**

(58) **Field of Search** D6/595, 596, 601,
D6/604, 605; D21/809; 5/15, 417, 419,
420, 630, 631, 633, 634, 636, 644, 645,
652, 653, 654, 655, 655.3, 706, 710, 713,
727

(56) **References Cited**

U.S. PATENT DOCUMENTS

| | | | | | |
|-------------|---|---------|---------------|-------|---------|
| D93,703 S | * | 10/1934 | Coomber | | D6/604 |
| D108,622 S | * | 3/1938 | Johnson | | D6/604 |
| 2,795,802 A | * | 6/1957 | Myers | | 5/636 |
| 3,566,423 A | * | 3/1971 | Reinfeldt | | 5/653 |
| D221,697 S | * | 8/1971 | Nicholson | | D21/809 |
| D259,458 S | * | 6/1981 | Fuller et al. | | D6/596 |
| D284,248 S | * | 6/1986 | Challen | | D6/601 |

| | | | | | |
|-------------|---|---------|------------------|-------|---------|
| 4,712,258 A | * | 12/1987 | Eves | | 5/655 |
| 5,103,514 A | * | 4/1992 | Leach | | 5/417 |
| D342,855 S | * | 1/1994 | Butler, III | | D6/601 |
| D357,595 S | * | 4/1995 | Roschacher | | D6/596 |
| D370,584 S | * | 6/1996 | Treadwell et al. | | D6/596 |
| D381,234 S | * | 7/1997 | Lupoff | | D6/596 |
| D390,618 S | * | 2/1998 | Wilson | | D21/809 |
| 5,855,033 A | * | 1/1999 | Frissen et al. | | 5/706 |
| D455,036 S | * | 4/2002 | Ku | | D6/604 |

* cited by examiner

Primary Examiner—Doris V. Coles

Assistant Examiner—T. Chase Nelson

(74) *Attorney, Agent, or Firm*—W. Wayne Liauh

(57) **CLAIM**

The ornamental design for inflatable mat, as shown.

DESCRIPTION

FIG. 1: shows a prespective view of the present design.
 FIG. 2: shows a front elevational view of the present design.
 FIG. 3: shows a rear elevational view of the present design.
 FIG. 4: shows a left elevational view of the present design.
 FIG. 5: shows a right elevational view of the present design.
 FIG. 6: shows a top plan view of the present design; and,
 FIG. 7: shows a bottom plan view of the present design.

1 Claim, 4 Drawing Sheets

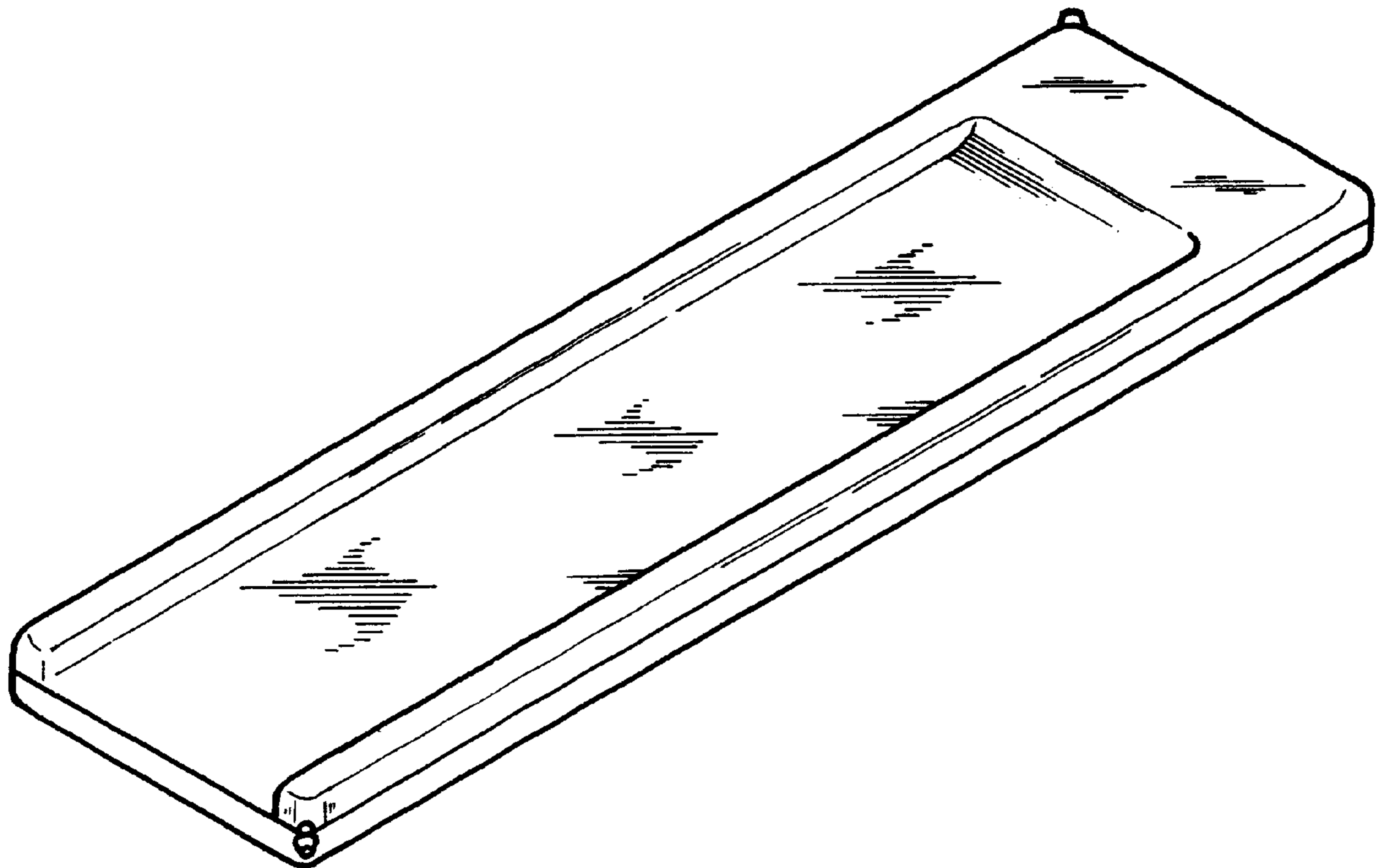

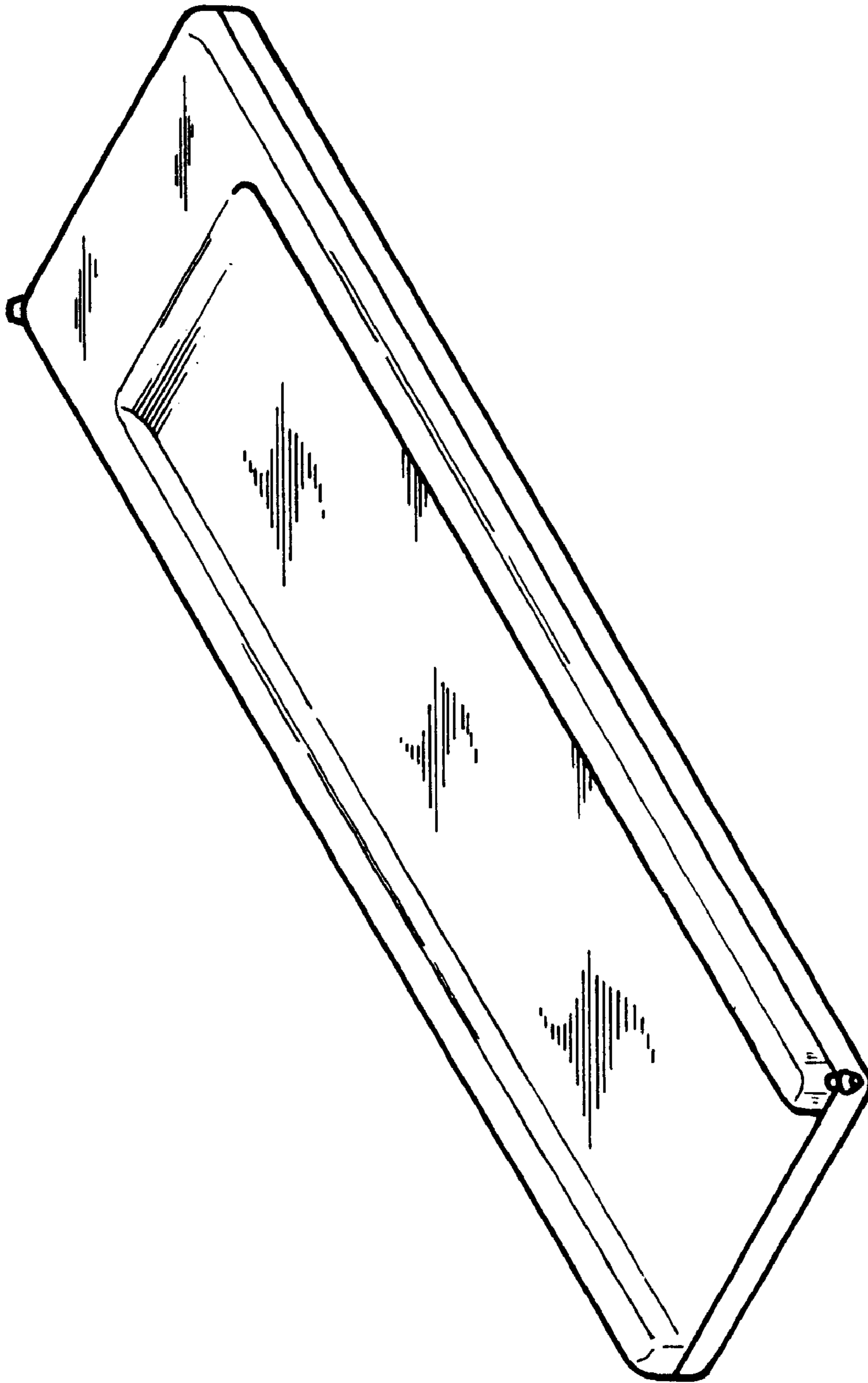

FIG. 1

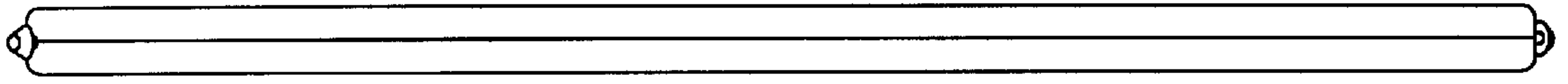

FIG. 2

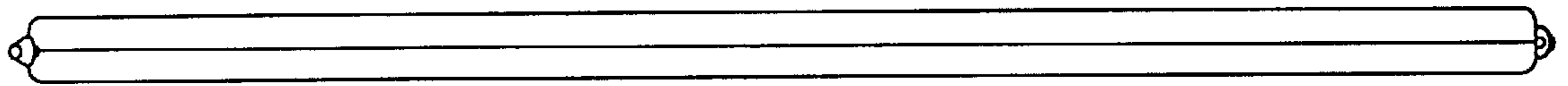

FIG. 3

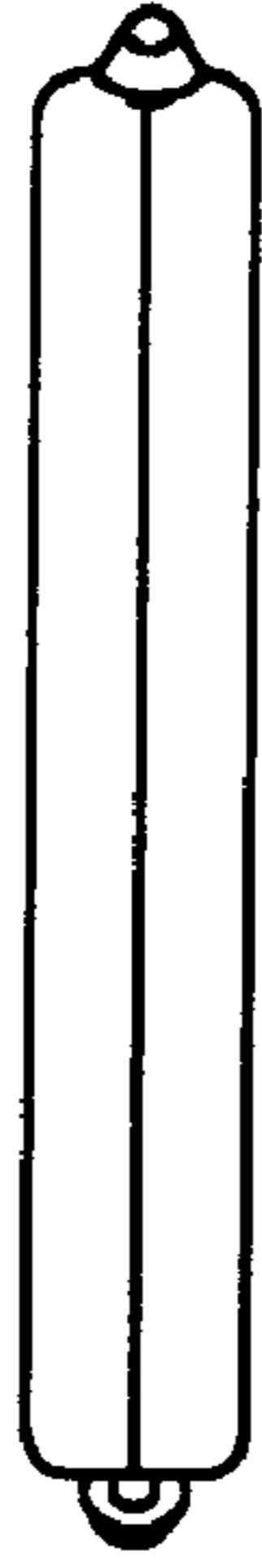

FIG. 5

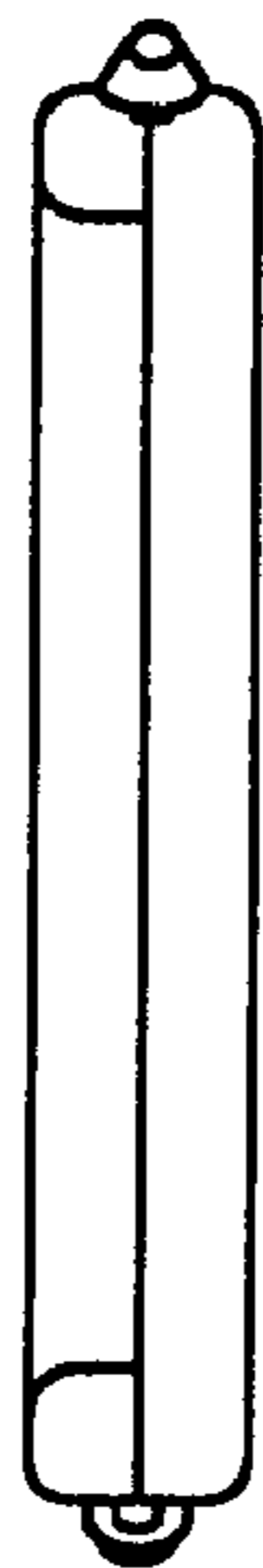

FIG. 4

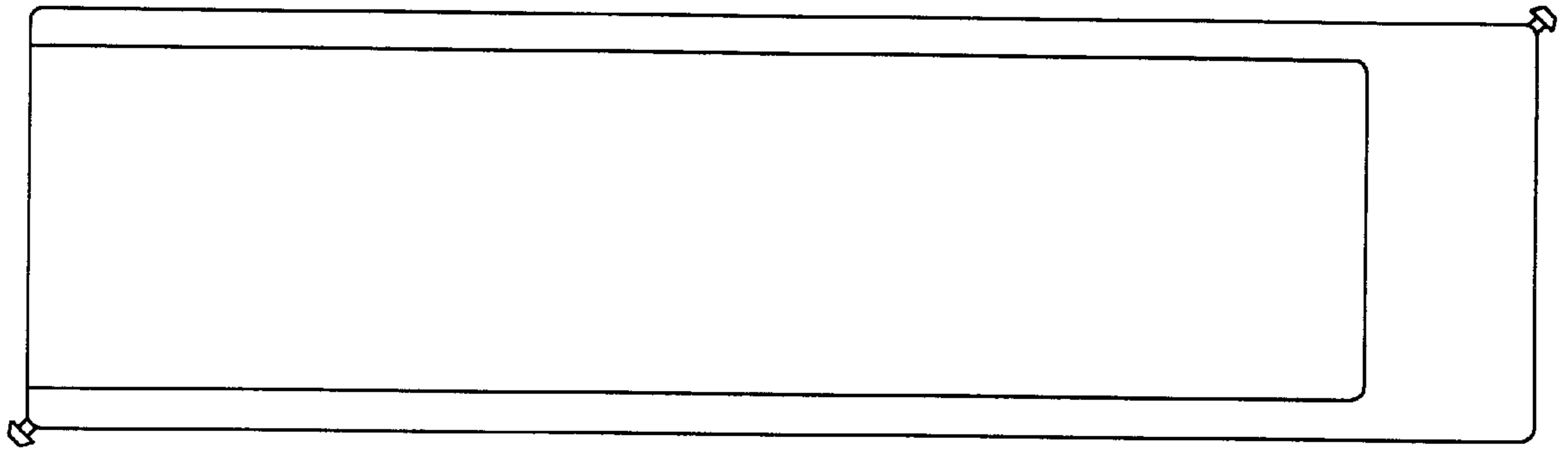

FIG. 6

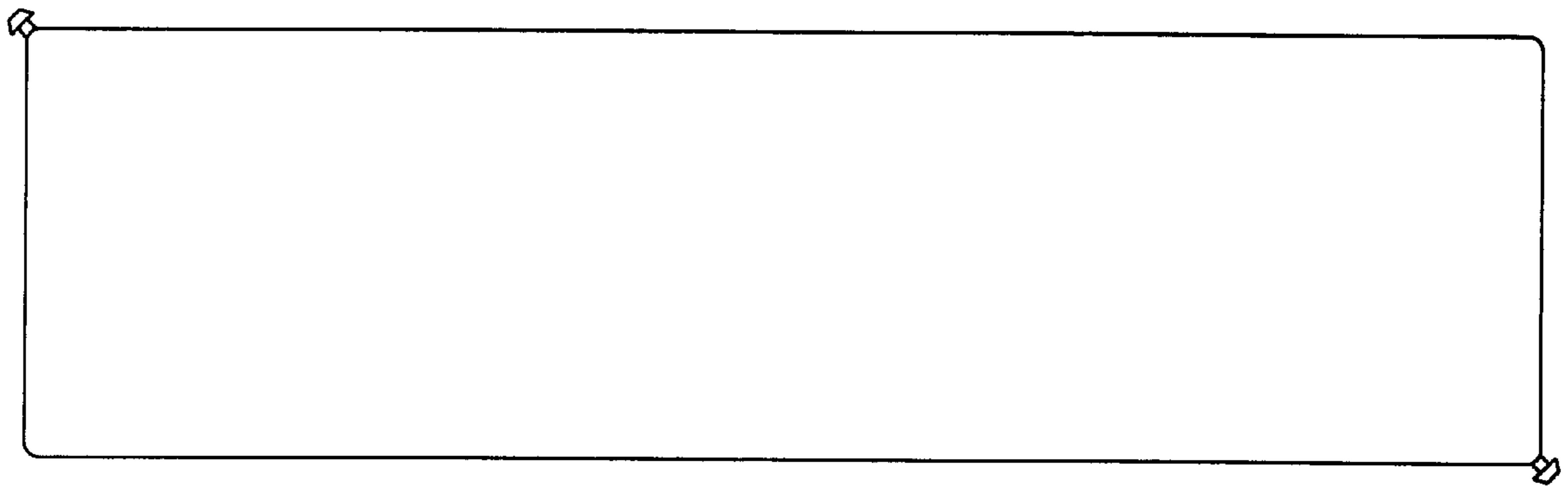

FIG. 7