



US00D463688S

(12) **United States Design Patent**  
**LaRoche**

(10) **Patent No.:** **US D463,688 S**

(45) **Date of Patent:** **\*\* Oct. 1, 2002**

(54) **TABLE EDGING**

(76) **Inventor:** **Rod LaRoche**, 2306 E. Apache Blvd.,  
Tempe, AZ (US) 85281

(\*\*) **Term:** **14 Years**

(21) **Appl. No.:** **29/138,898**

(22) **Filed:** **Mar. 21, 2001**

(51) **LOC (7) Cl.** ..... **06-06**

(52) **U.S. Cl.** ..... **D6/491; D6/511**

(58) **Field of Search** ..... **D6/480-489, 511,**  
**D6/491; 108/150, 151, 153.1, 155, 156;**  
**248/915, 345.1; D8/403**

(56) **References Cited**

**U.S. PATENT DOCUMENTS**

- 3,512,829 A \* 5/1970 Paris
- D248,268 S \* 6/1978 Fields ..... D6/511
- D362,573 S \* 9/1995 Finlayson et al. .... D6/511

\* cited by examiner

*Primary Examiner*—Janice E. Seeger

(74) *Attorney, Agent, or Firm*—Schmeiser, Olsen & Watts

(57) **CLAIM**

The ornamental design for table edging, as shown and described.

**DESCRIPTION**

FIG. 1 is a side view of the table edging. Views of each other side are identical;

FIG. 2 is a horizontal corner view of the table edging. Views of each other corner are identical;

FIG. 3 is a bottom corner perspective view of the table edging;

FIG. 4 is a top corner perspective view of the table edging;

FIG. 5 is a bottom view of the table edging; and,

FIG. 6 is a top view of the table edging.

The broken lines are for environmental purposes only and form no part of the claimed design.

**1 Claim, 6 Drawing Sheets**

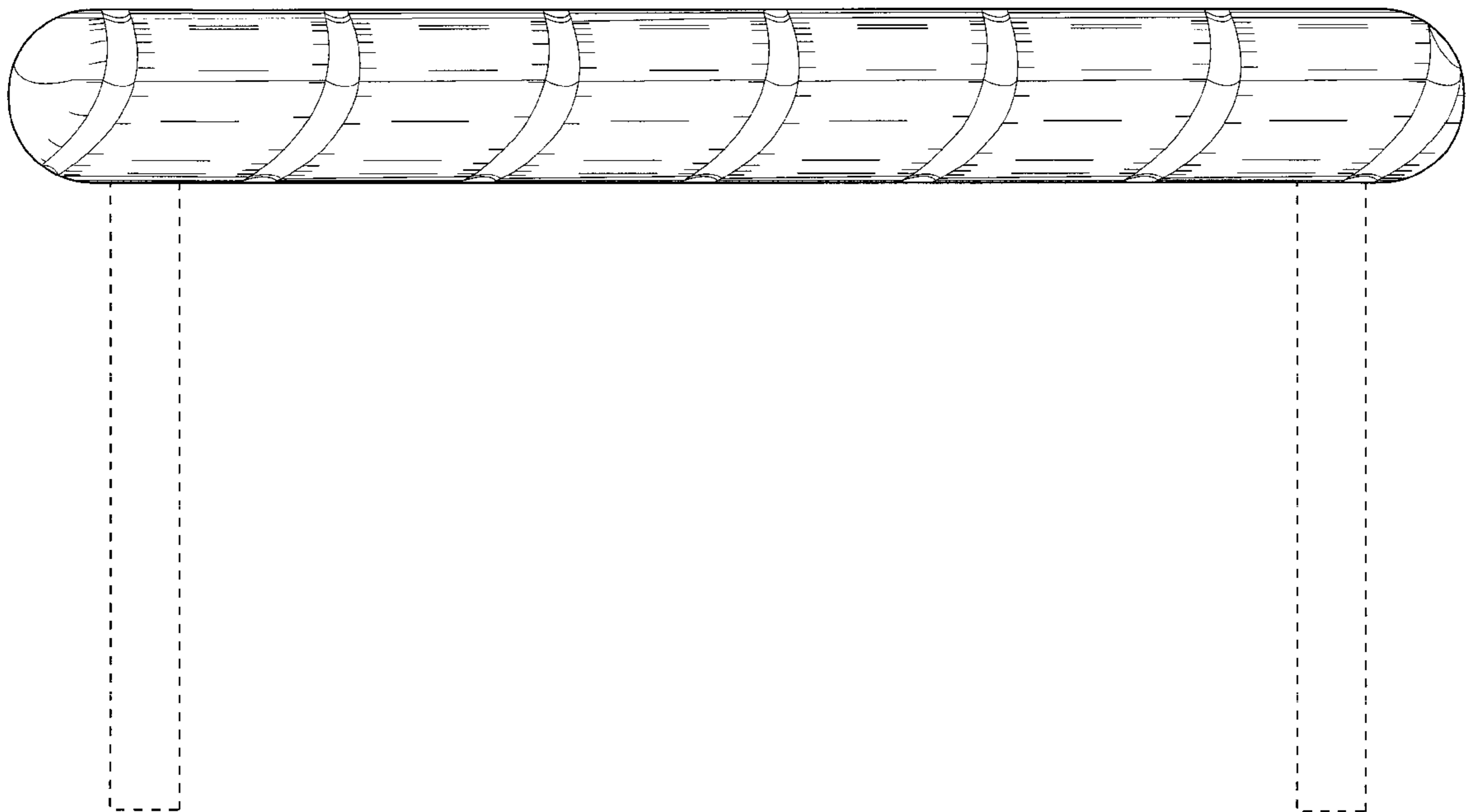

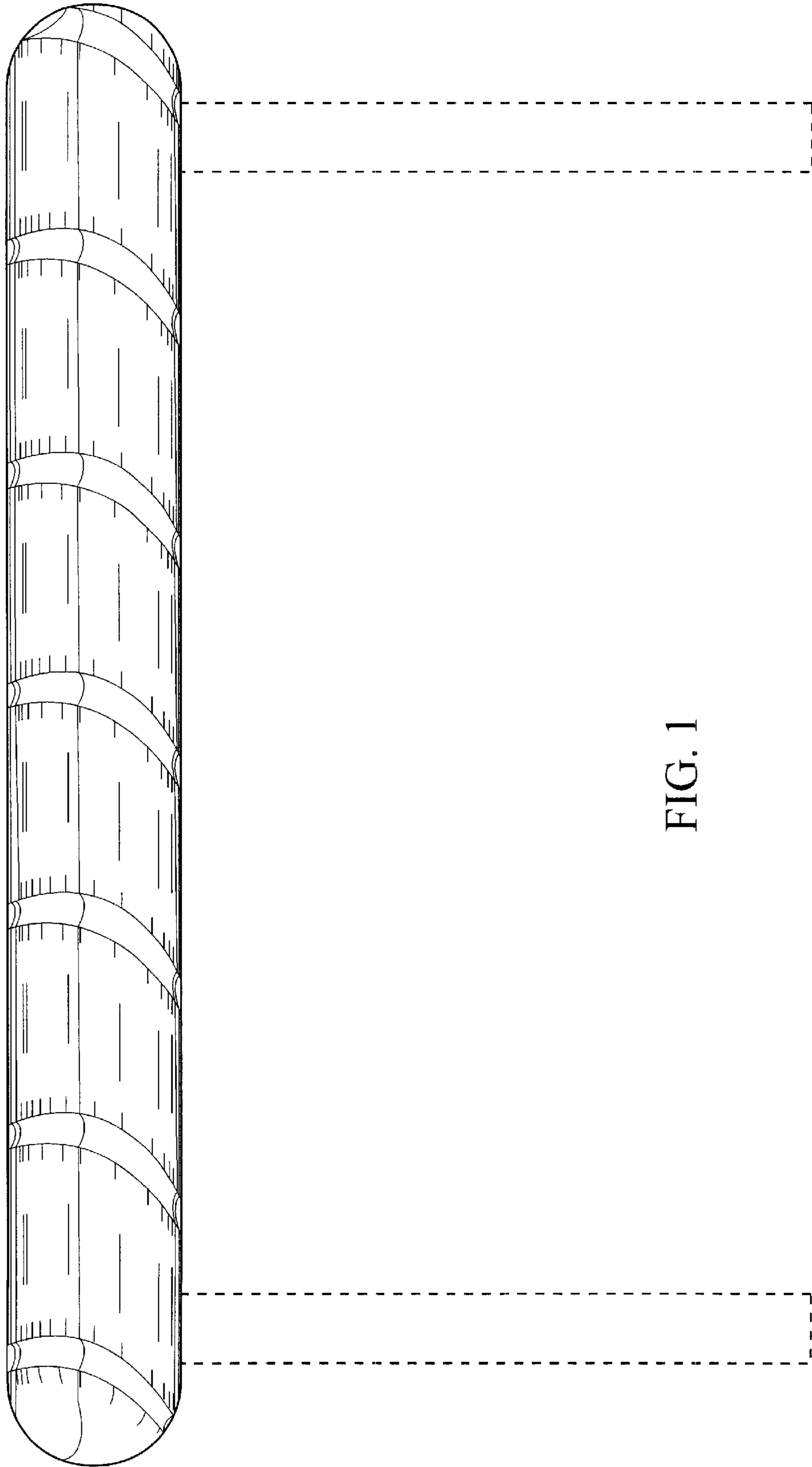

FIG. 1

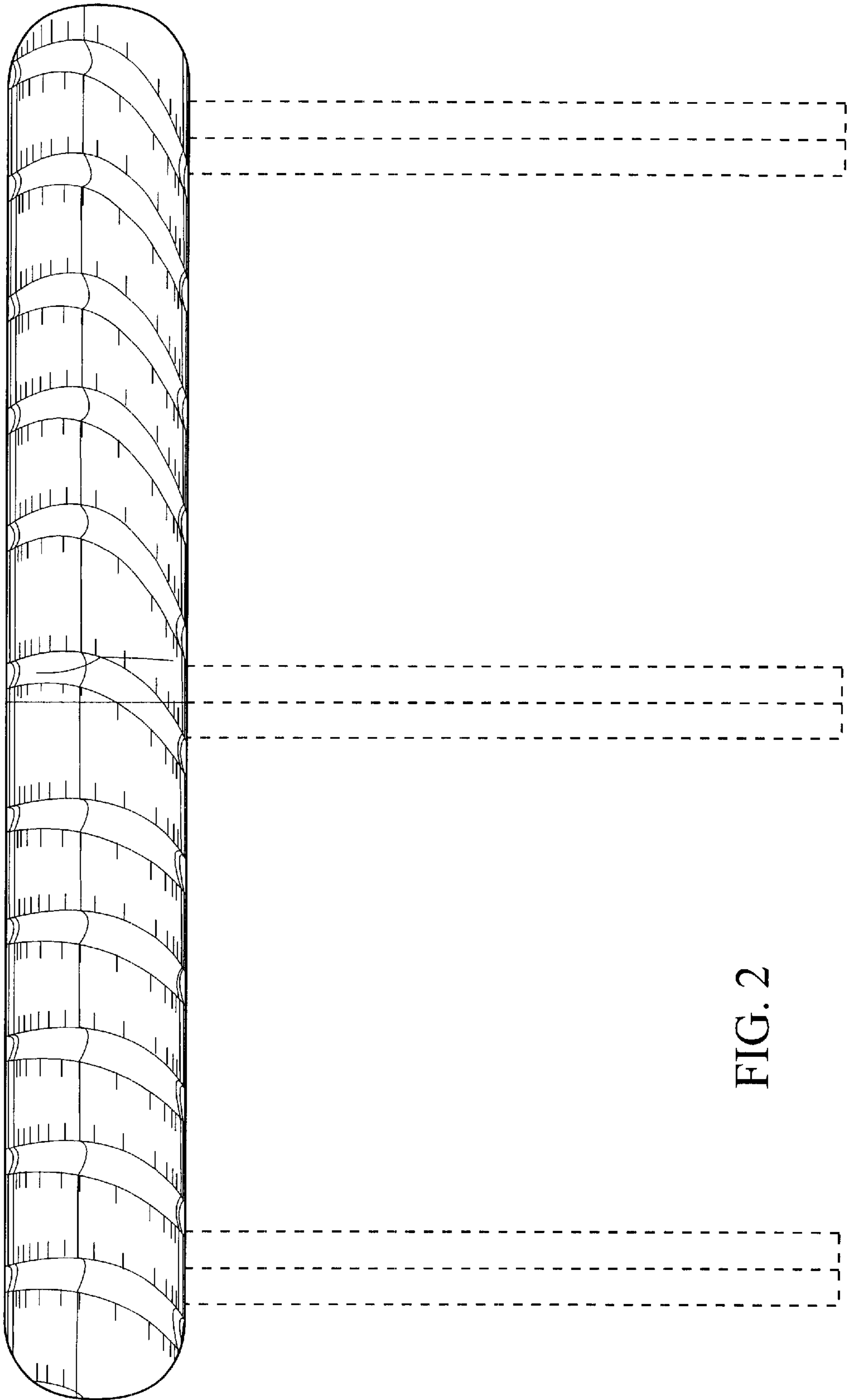

FIG. 2

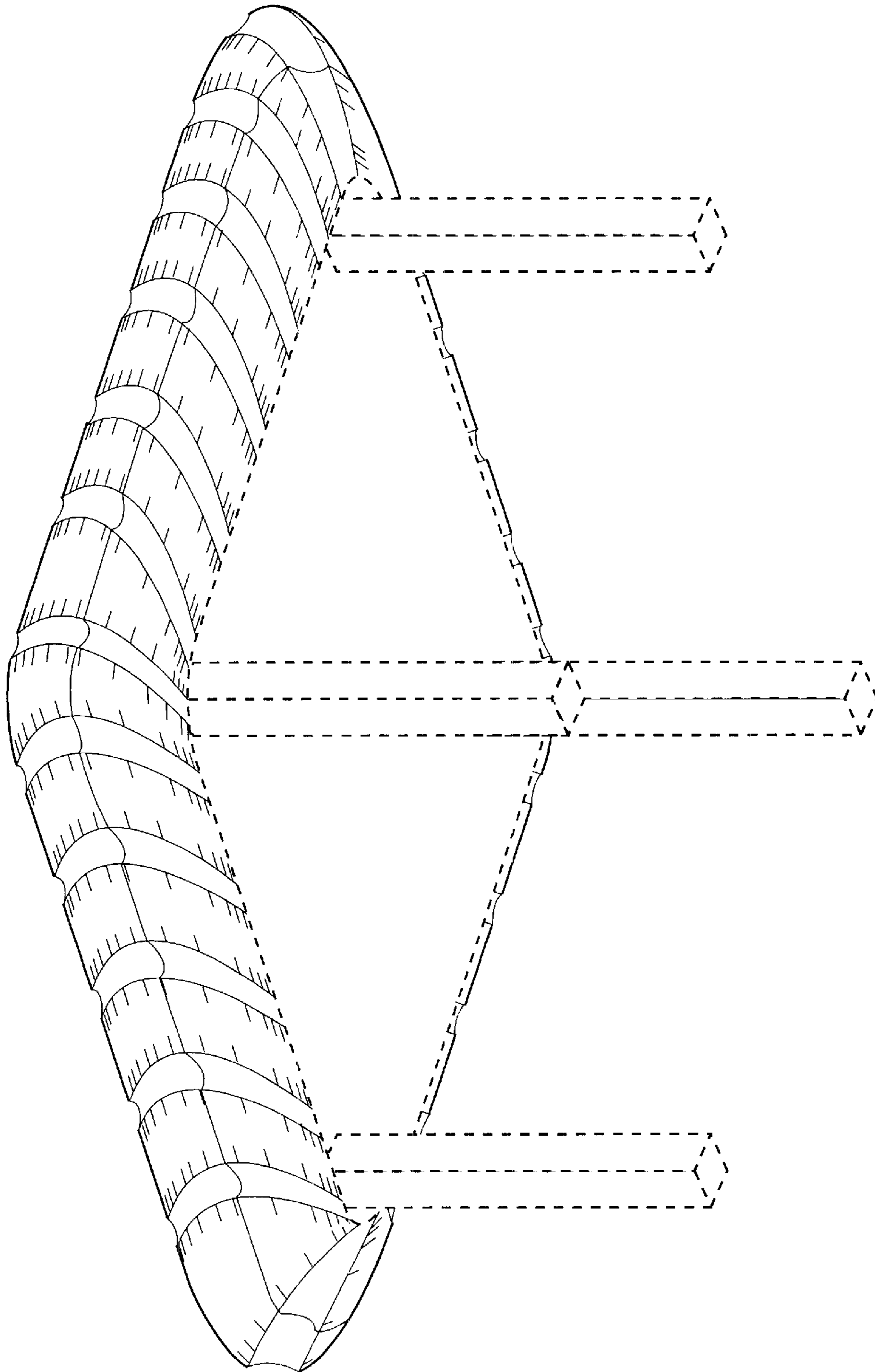

FIG. 3

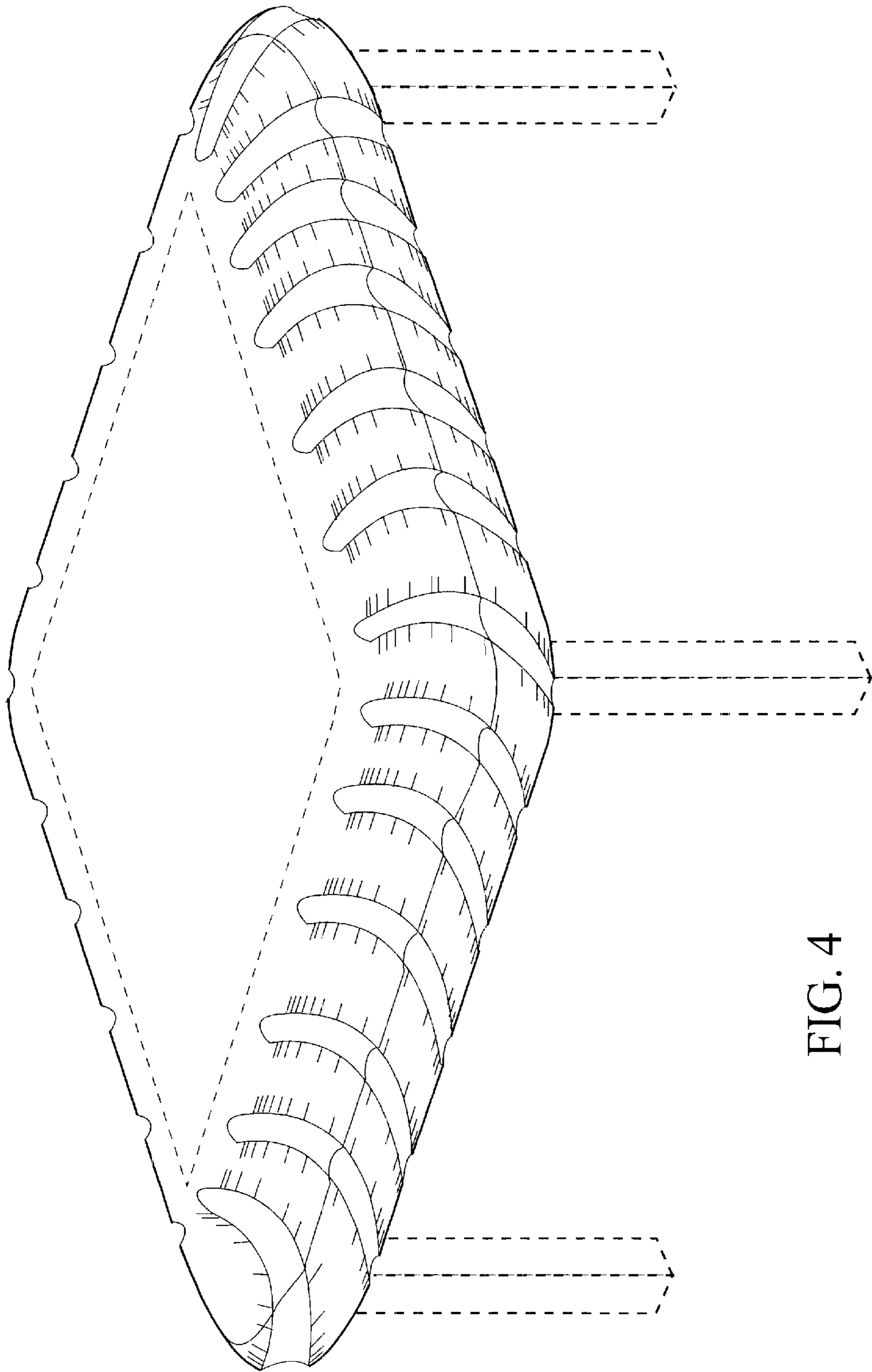

FIG. 4

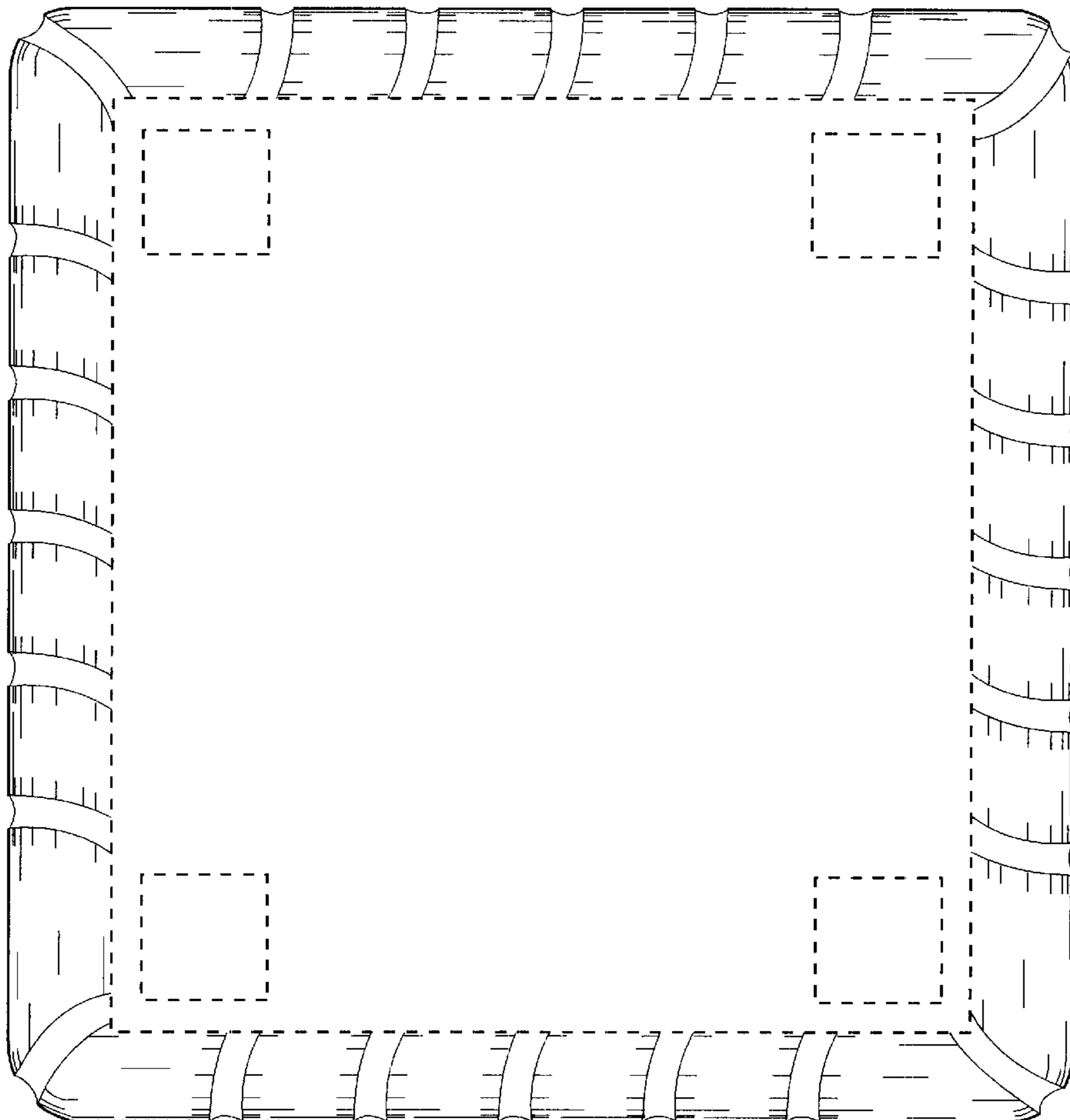

FIG. 5

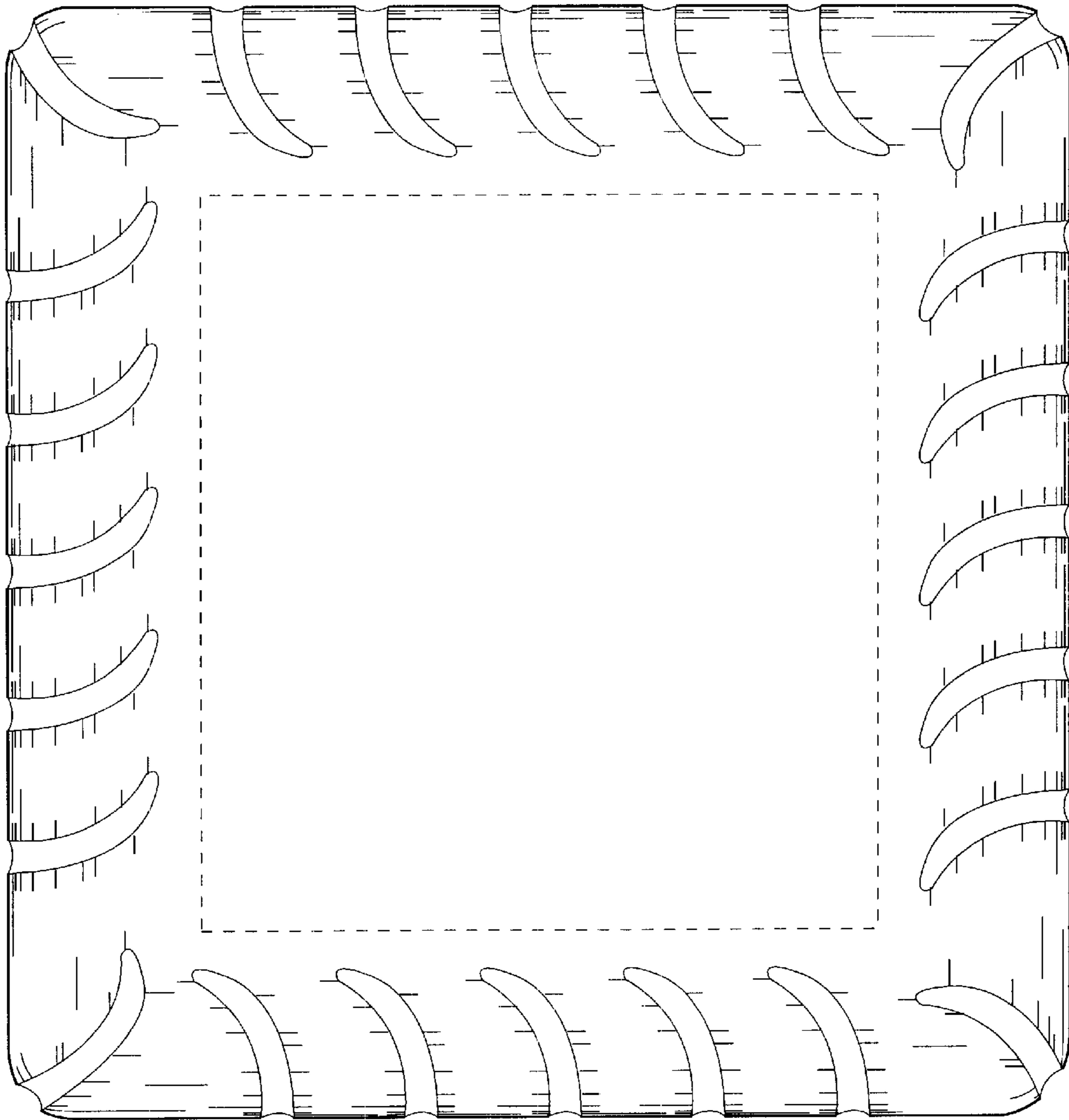

FIG. 6