



US00D463641S

(12) **United States Design Patent**
Powell

(10) **Patent No.:** **US D463,641 S**

(45) **Date of Patent:** **** Sep. 24, 2002**

(54) **STEAM STATION BASE**

(75) **Inventor:** **Dick Powell**, London (GB)

(73) **Assignee:** **Calor S.A.**, Lyons (FR)

(**) **Term:** **14 Years**

(21) **Appl. No.:** **29/145,494**

(22) **Filed:** **Jul. 25, 2001**

(30) **Foreign Application Priority Data**

Jan. 25, 2001 (FR) 01 0452

(51) **LOC (7) Cl.** **07-03**

(52) **U.S. Cl.** **D32/71; D32/73**

(58) **Field of Search** D32/68, 71, 73;
38/75, 77.5, 77.6, 77.7, 79, 96, 141, 142;
219/245-247, 259; 248/117.1, 117.2, 117.3;
392/394, 403, 404

(56) **References Cited**

U.S. PATENT DOCUMENTS

- 374,527 A 12/1887 Emerson
- 388,576 A 8/1888 Nordenfelt
- D370,324 S * 5/1996 Villa D32/73
- D374,527 S * 10/1996 Gudefin D32/68
- D379,702 S * 6/1997 Gudefin et al. D32/73

- D408,107 S * 4/1999 Clouet D32/73
- D439,023 S 3/2001 Powell
- 6,212,332 B1 * 4/2001 Sham et al. 392/404

FOREIGN PATENT DOCUMENTS

- GB 2330843 * 5/1999
- WO WO 01/53596 * 7/2001

* cited by examiner

Primary Examiner—Alan P. Douglas

Assistant Examiner—Lavone Tabor

(74) *Attorney, Agent, or Firm*—Browdy and Neimark, P.L.L.C.

(57) **CLAIM**

The ornamental design for a steam station base, as shown and described.

DESCRIPTION

FIG. 1 is a perspective view of a steam station base in accordance with the present design; FIG. 2 is a right side view thereof; FIG. 3 is a left side view thereof; FIG. 4 is a front view thereof; FIG. 5 is a rear view thereof; FIG. 6 is top plan view thereof; and, FIG. 7 is a bottom plan view thereof.

1 Claim, 7 Drawing Sheets

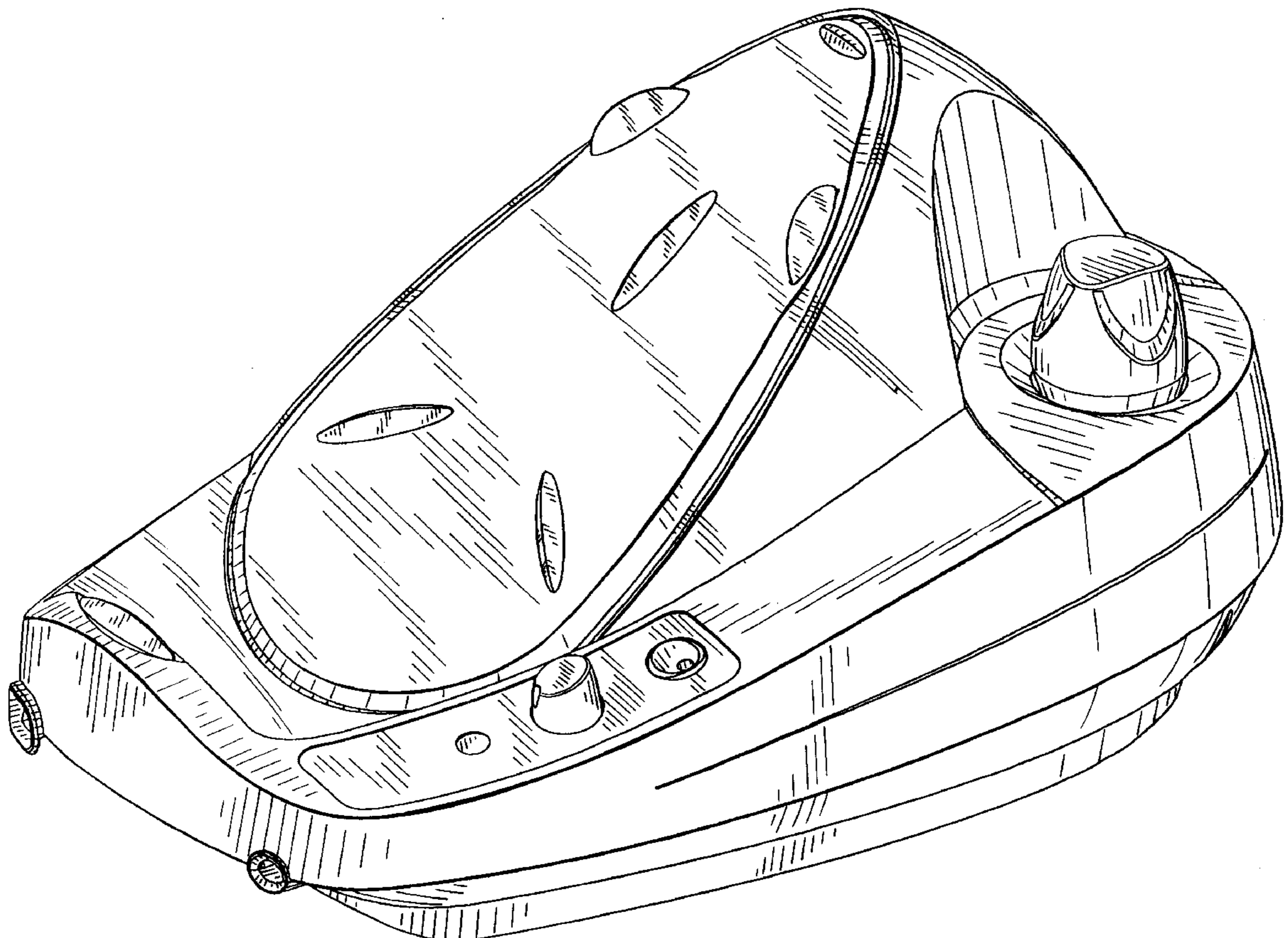

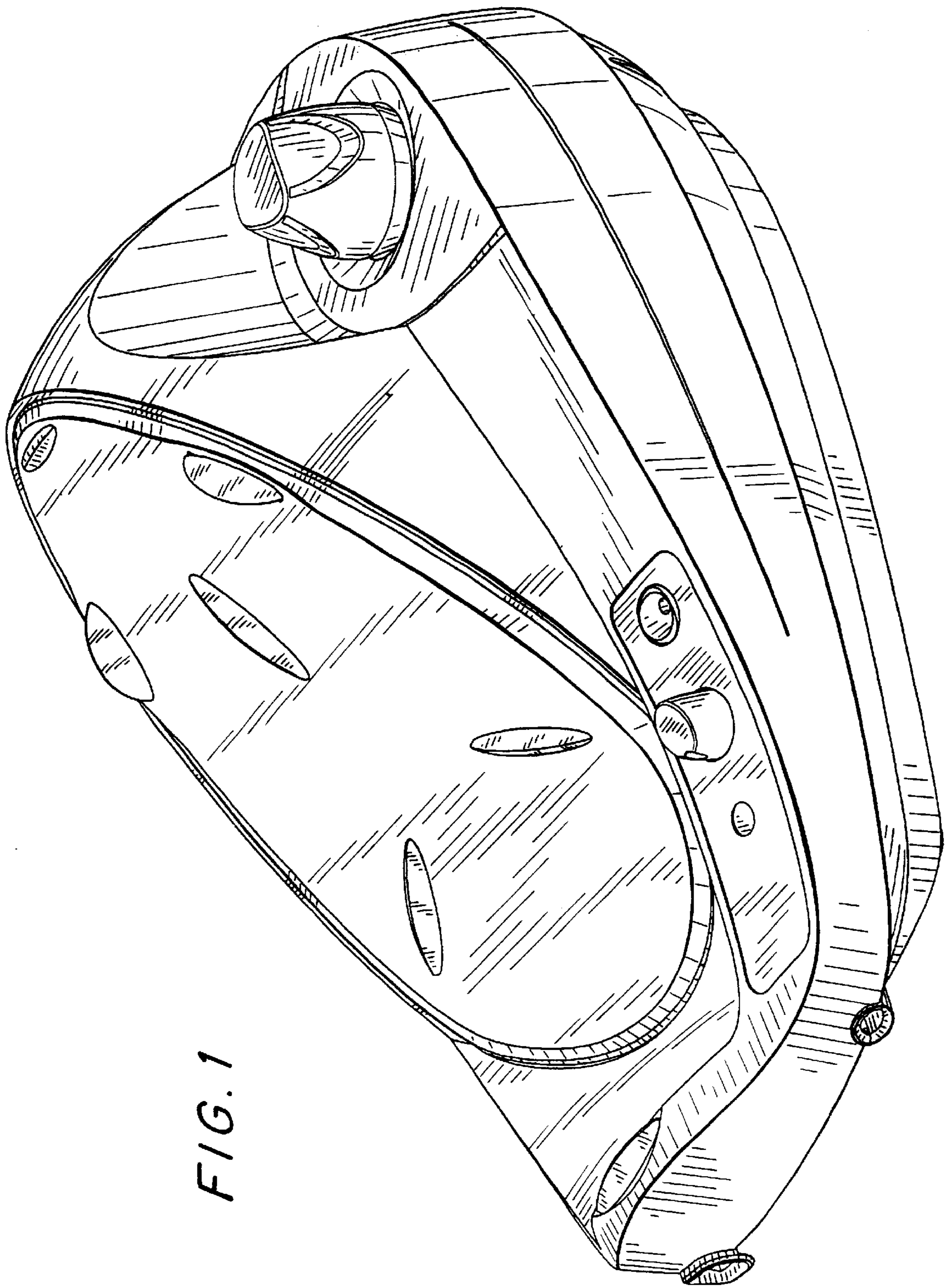

FIG. 1

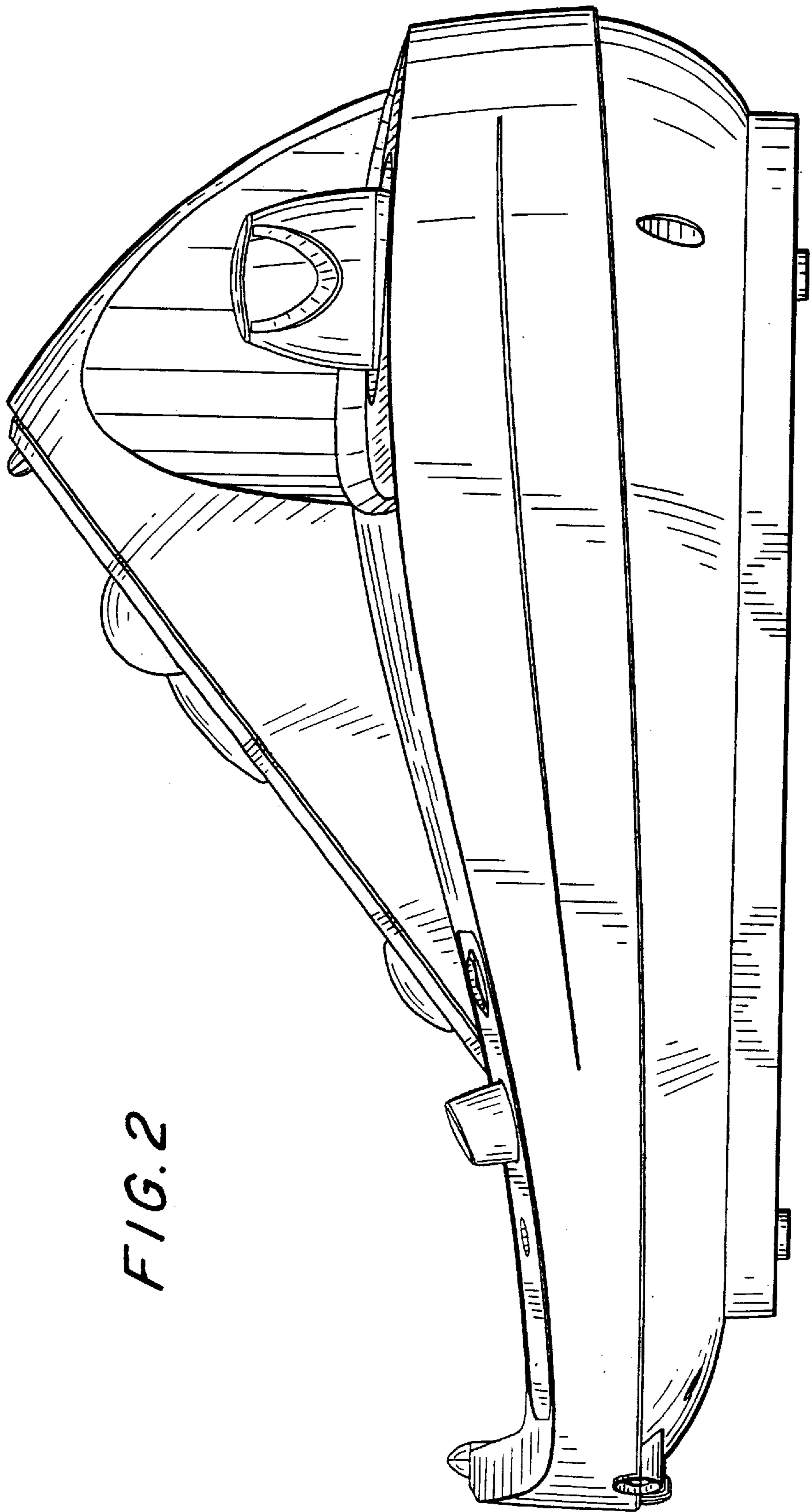

FIG. 2

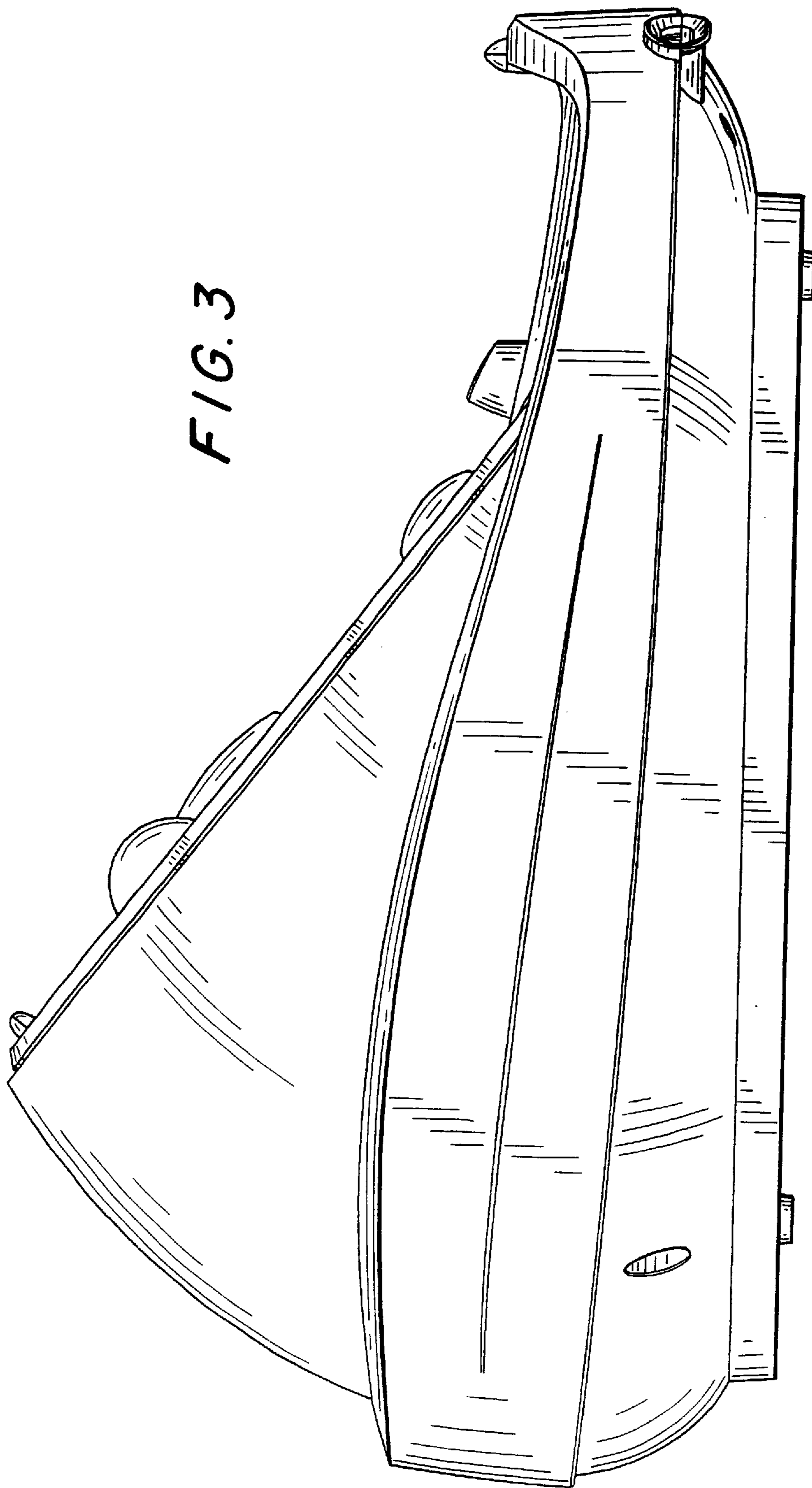

FIG. 3

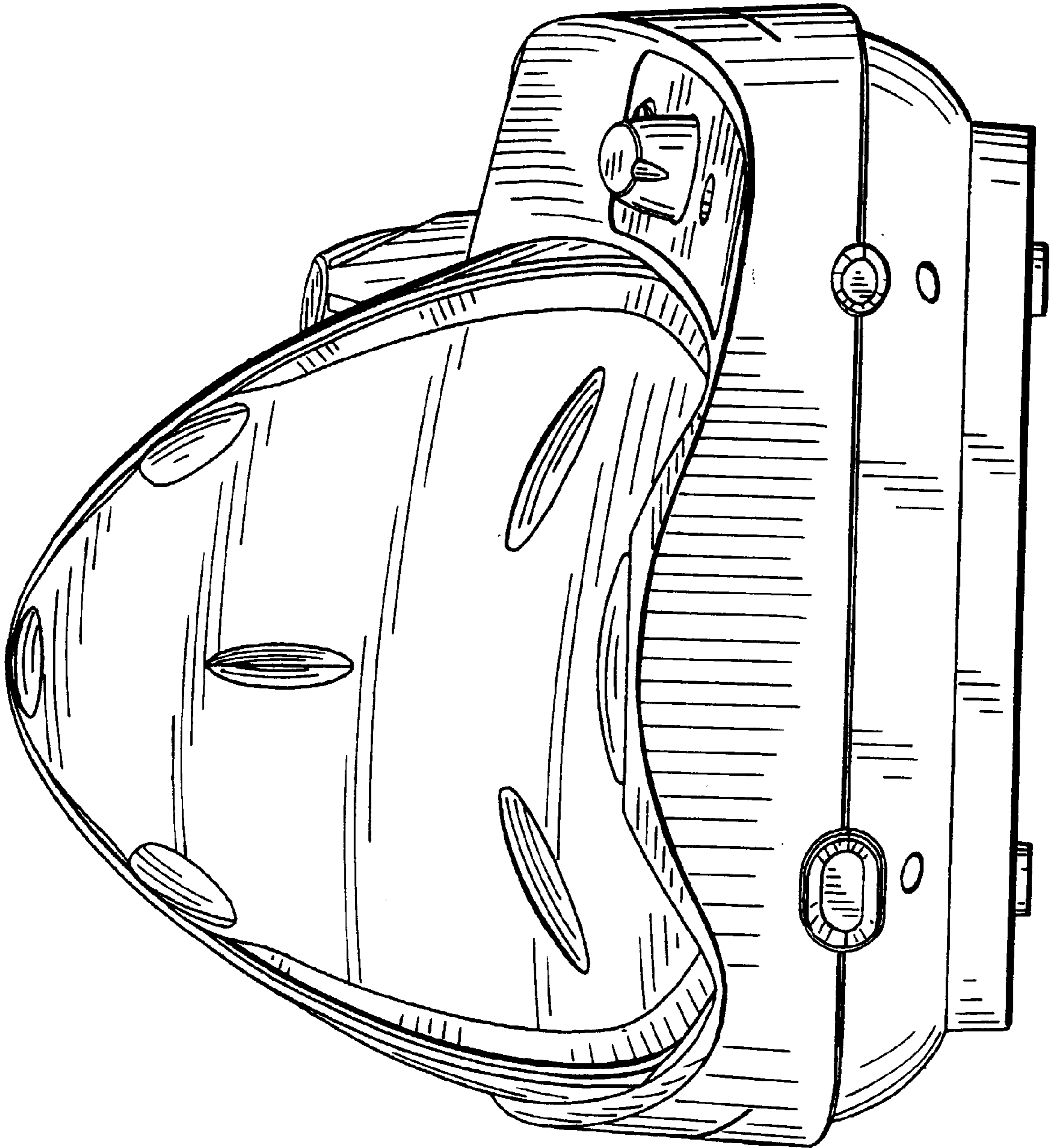

FIG. 4

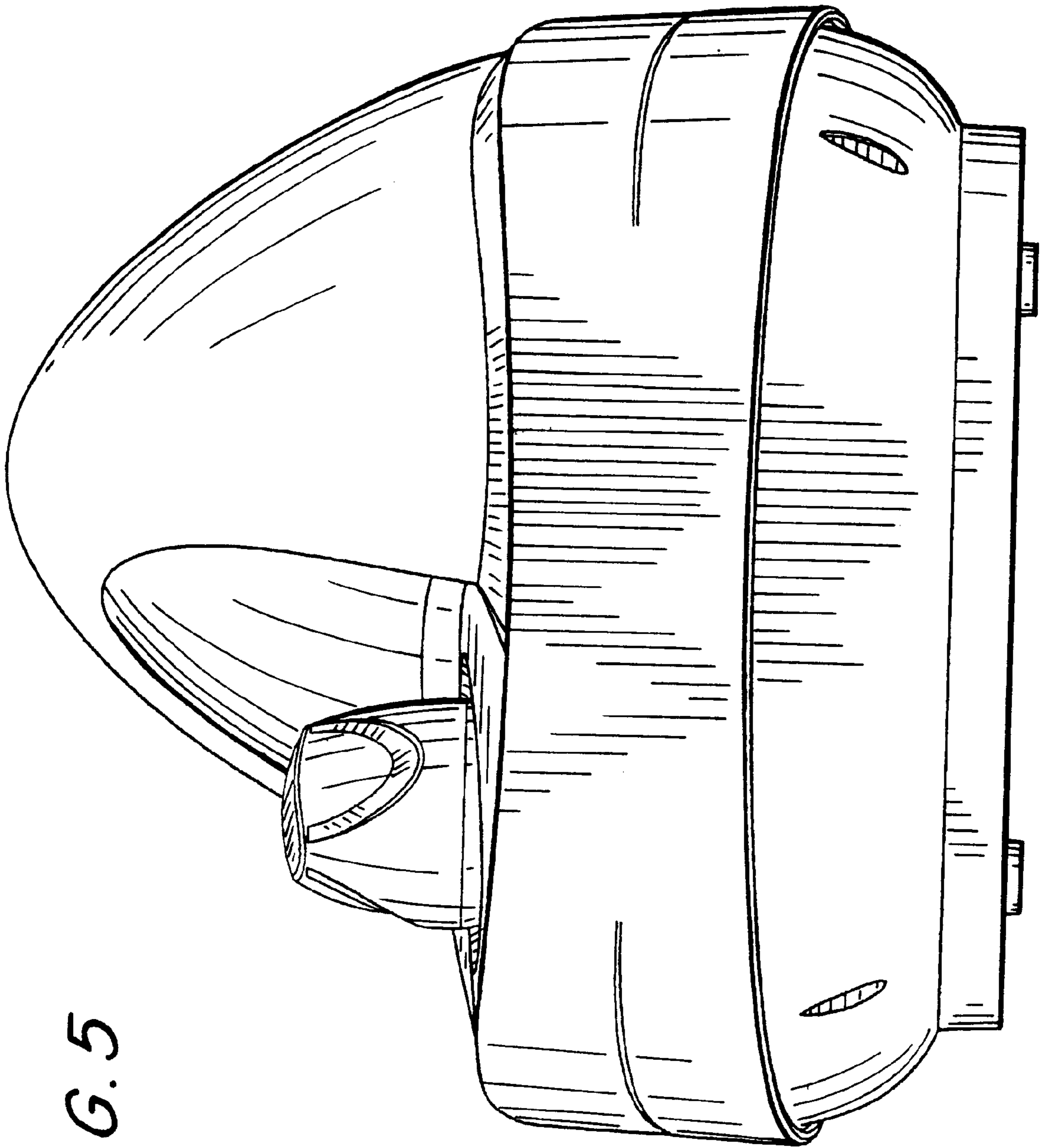

FIG. 5

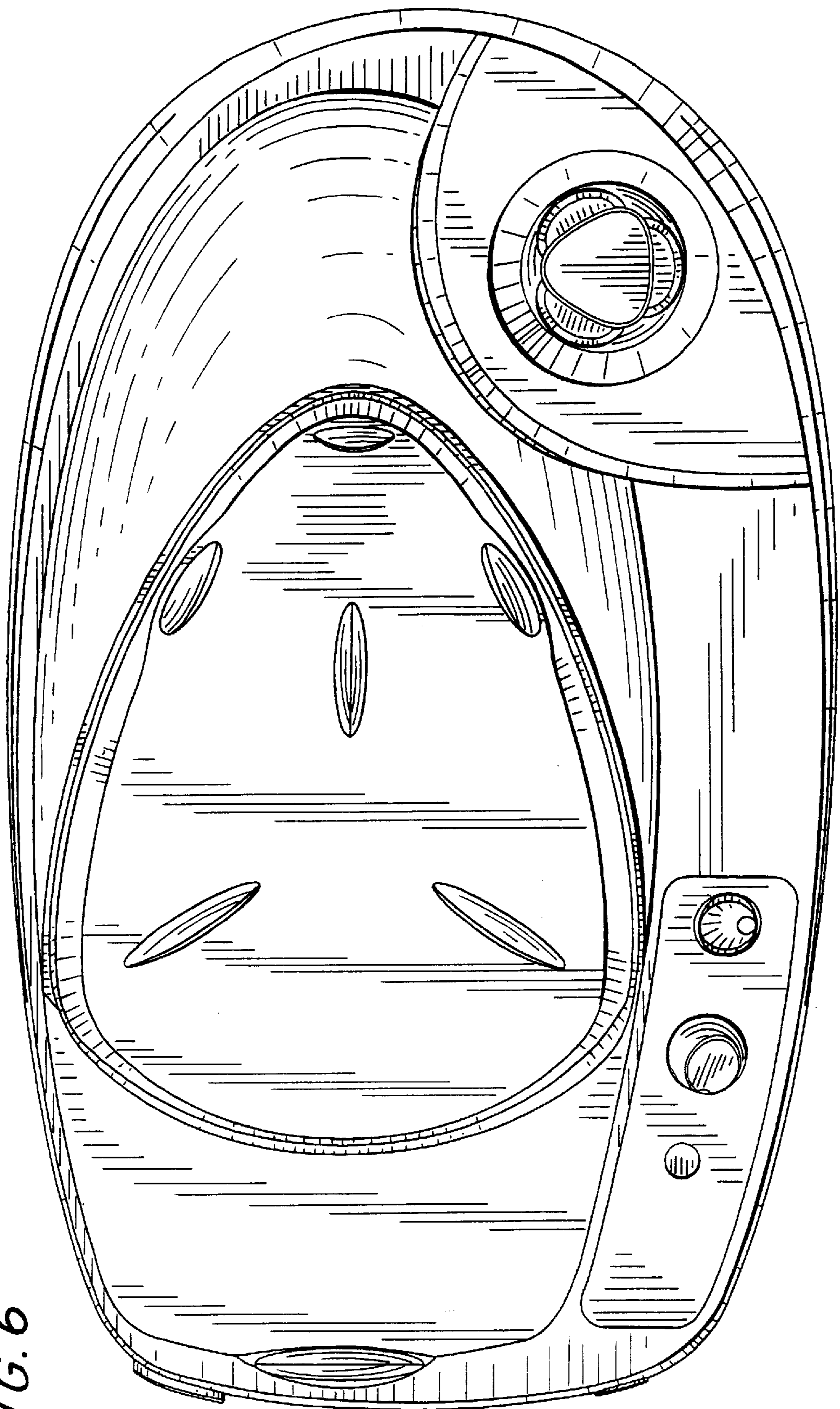

FIG. 6

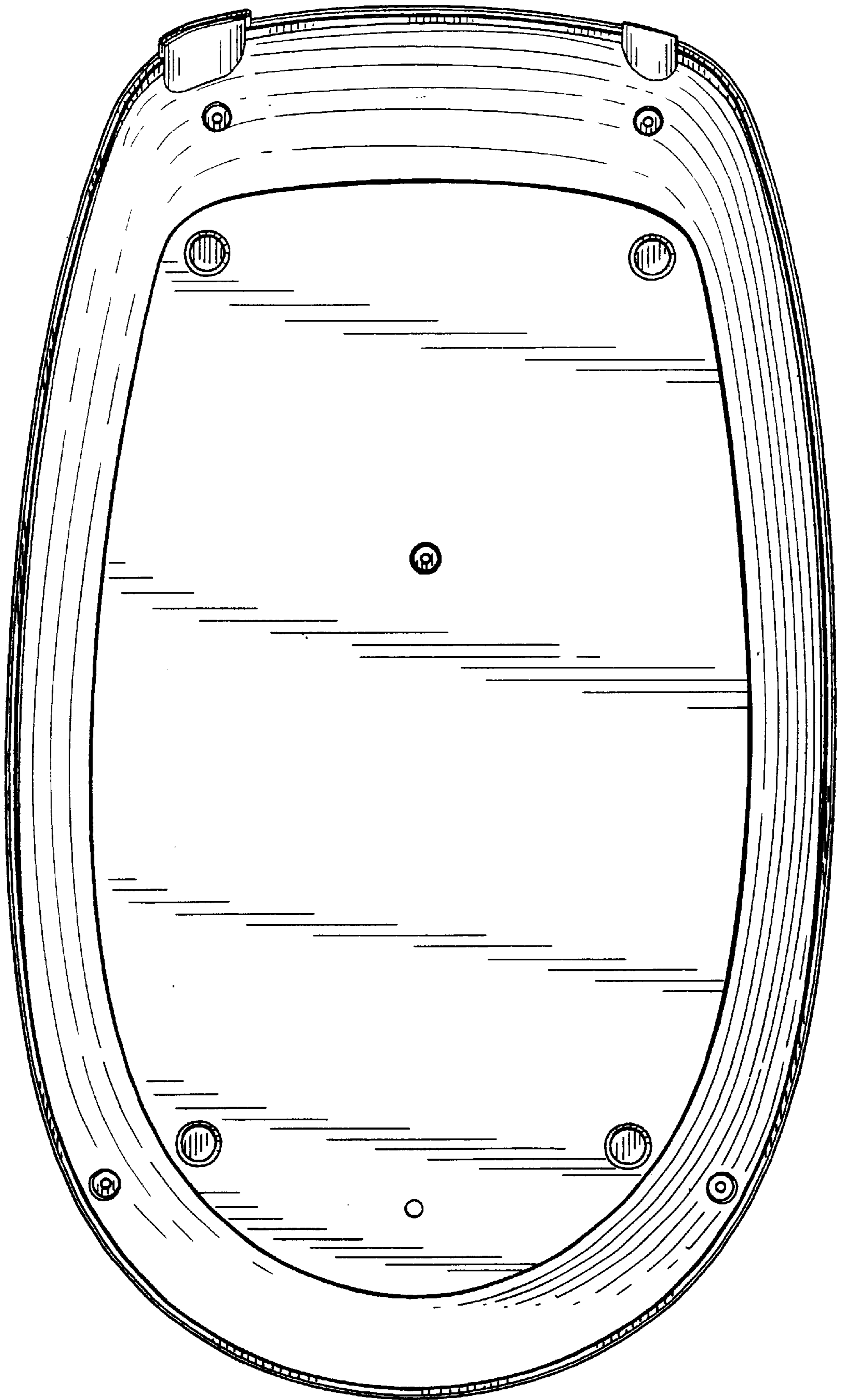

FIG. 7