



US00D463575S

(12) **United States Design Patent**
Daudet et al.

(10) **Patent No.: US D463,575 S**

(45) **Date of Patent: ** Sep. 24, 2002**

(54) **SPACER BAR**

(75) Inventors: **Larry R. Daudet**, Porter, IN (US);
Edmund L. Ponko, Pittsburgh, PA
(US); **Gregory S. Ralph**, Valparaiso, IN
(US)

(73) Assignee: **Dietrich Industries, Inc.**, Pittsburgh,
PA (US)

(**) Term: **14 Years**

(21) Appl. No.: **29/123,510**

(22) Filed: **May 18, 2000**

(51) **LOC (7) Cl. 25-02**

(52) **U.S. Cl. D25/61**

(58) **Field of Search 52/677, 684, 696,**
52/697; D25/61

(56) **References Cited**

U.S. PATENT DOCUMENTS

894,711 A	7/1908	Worcester
947,514 A	1/1910	Stevens
1,656,741 A	1/1928	Lane
2,686,959 A	8/1954	Robinson
2,964,807 A	12/1960	Kennedy

(List continued on next page.)

FOREIGN PATENT DOCUMENTS

CA	23961/77	10/1978
CA	2077170	3/1994
GB	2103264 A	2/1983

OTHER PUBLICATIONS

Metal Lite Inc. Brochure, Jul. 1991, Anaheim, California.
E.N. Lorre, Residential Steel Framing Construction Guide,
1993, Laguna Hills, CA, C.3, C.2B, C.4, C.5, C.6, C.7, C.8,
C.9, C.17, C.18, C.25, C.26, D.9, D.10, D.11, D.12, D.13A,
D.13B, D.14, D.15, D.21A, D.20, D.21B, D.22, D.23, E.11,
E.12, E.13, E.14, E.15, E.16, E.19, F.1, F.2, F.3, F.4, F.5, F.6,
F.7, F.8, F.13, F.14, F.15, F.16, F.19, F.20.

Dietrich Industries, Inc., 1st Step To Residential Metal
Framing (Non-Load Bearing Walls), Jun. 1994, Pittsburgh,
PA.

Angles Metal Systems, Technical Data Sheets 107 and 108,
1984, Los Angeles, CA.

Primary Examiner—Doris Clark

(74) *Attorney, Agent, or Firm*—Kirkpatrick & Lockhart
LLP

(57) **CLAIM**

The ornamental design for the spacer bar, as shown and
described.

DESCRIPTION

FIG. 1 is a perspective view of another embodiment of the
spacer bar of the present invention;
FIG. 2 is a front elevational view of the spacer bar;
FIG. 3 is a rear elevational view of the spacer bar;
FIG. 4 is a top view of the spacer bar;
FIG. 5 is a bottom view of the spacer bar;
FIG. 6 is a right side elevational view of the spacer bar;
FIG. 7 is a left side elevational view of the spacer bar;
FIG. 8 is a perspective view of another embodiment of the
spacer bar of the present invention;
FIG. 9 is a front elevational view of the spacer bar;
FIG. 10 is a rear elevational view of the spacer bar;
FIG. 11 is a top view of the spacer bar;
FIG. 12 is a bottom view of the spacer bar;
FIG. 13 is a right side elevational view of the spacer bar;
FIG. 14 is a left side elevational view of the spacer bar;
FIG. 15 is a perspective view of another embodiment of the
spacer bar of the present invention;
FIG. 16 is a front elevational view of the spacer bar;
FIG. 17 is a rear elevational view of the spacer bar;
FIG. 18 is a top view of the spacer bar;
FIG. 19 is a bottom view of the spacer bar;
FIG. 20 is a right side elevational view of the spacer bar;
and,
FIG. 21 is a left side elevational view of the spacer bar.

1 Claim, 9 Drawing Sheets

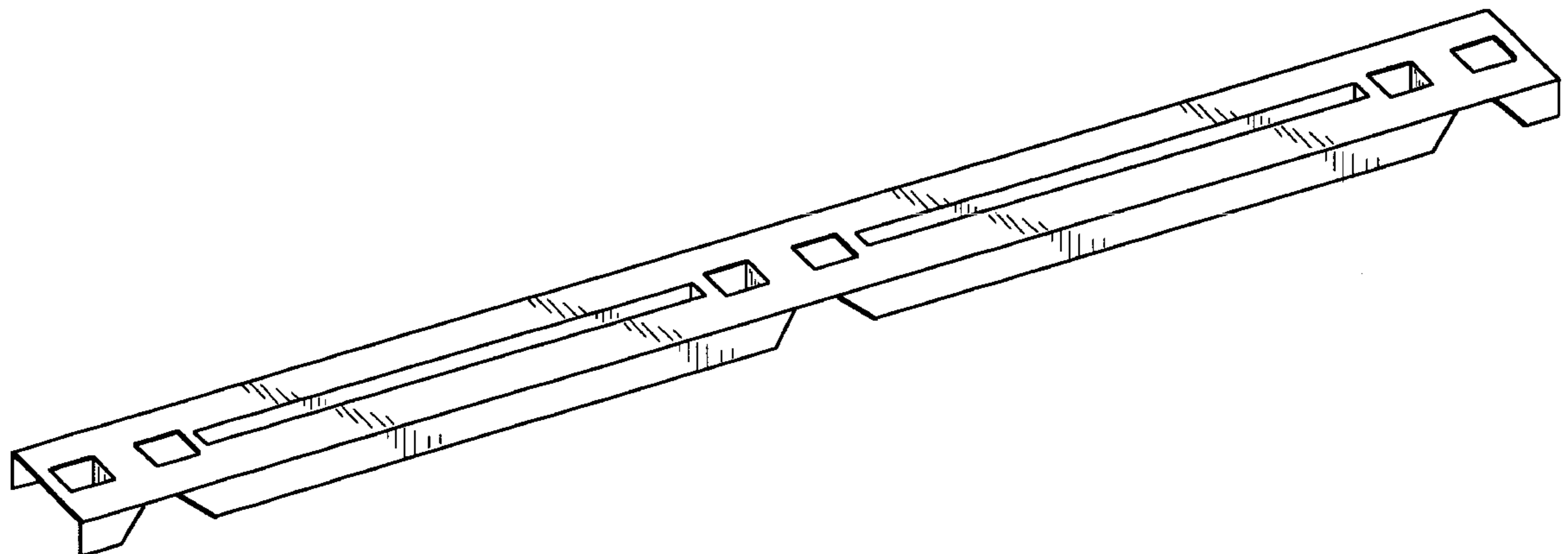

US D463,575 S

Page 2

U.S. PATENT DOCUMENTS

2,966,708 A	1/1961	Freeman, Jr.	4,843,726 A	7/1989	Ward
3,201,874 A	8/1965	Christy	4,986,052 A	1/1991	Nelson
3,668,828 A	6/1972	Nicholas et al.	5,161,345 A	11/1992	Sobjack, Sr.
3,908,328 A	9/1975	Nelsson	5,274,973 A	1/1994	Liang
4,075,810 A	2/1978	Zakrzewski et al.	5,313,752 A	5/1994	Hatzinikolas
4,080,771 A	3/1978	Weller	5,353,560 A	10/1994	Heydon
4,227,360 A	10/1980	Balinski	5,551,200 A	9/1996	Krug
4,246,736 A	1/1981	Kovar et al.	D374,292 S	* 10/1996	Koo et al. D25/61
4,426,822 A	1/1984	Gailey	5,822,942 A	10/1998	Lucia, Jr.
4,538,391 A	9/1985	Skrabis et al.	5,870,874 A	2/1999	Brothers
4,637,195 A	1/1987	Davis	5,899,042 A	* 5/1999	Pellock 52/696
4,688,358 A	8/1987	Madray	6,021,618 A	2/2000	Elderson
4,704,829 A	11/1987	Baumker, Jr.			

* cited by examiner

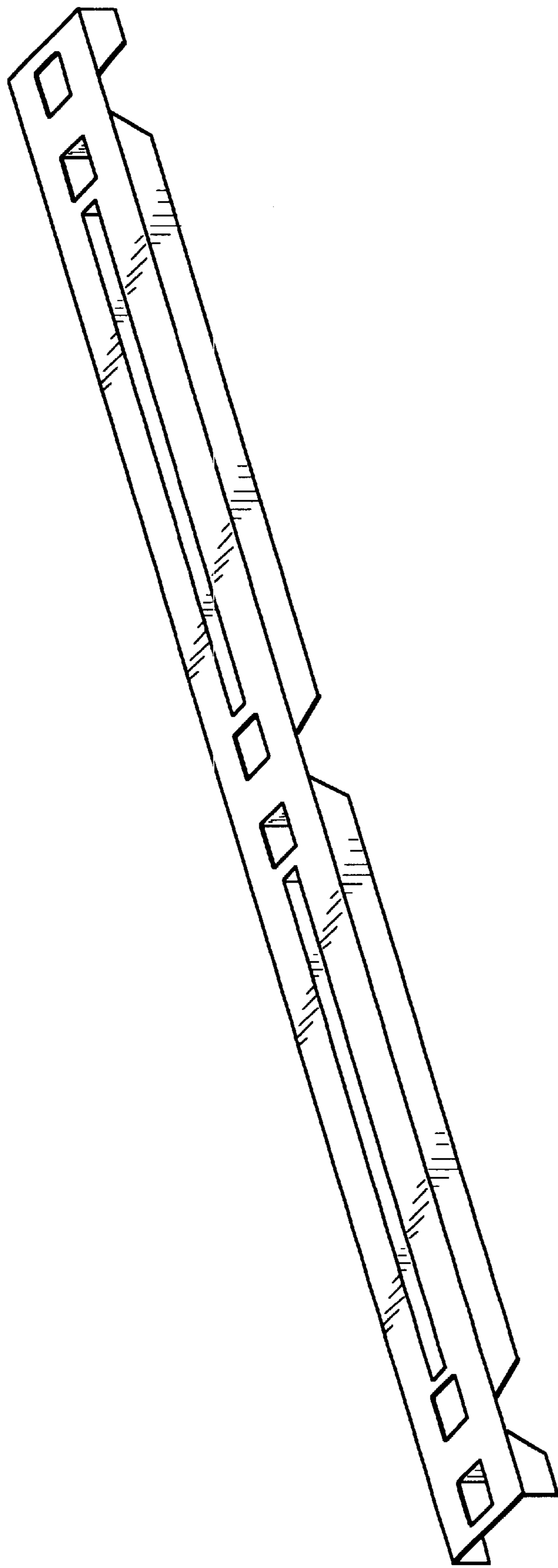

FIG. 1



FIG. 2



FIG. 3

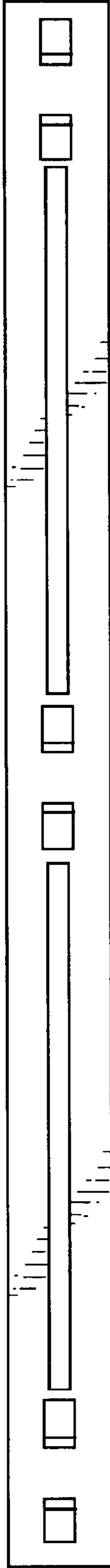

FIG. 4

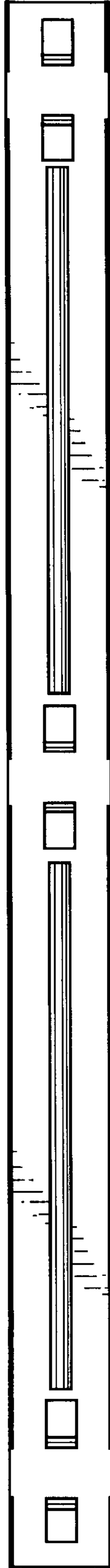

FIG. 5

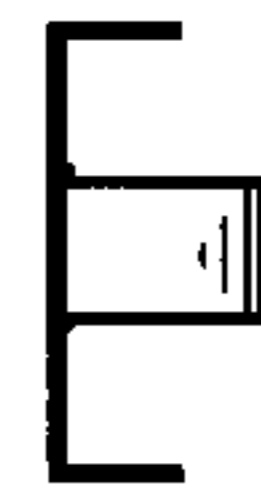

FIG. 6

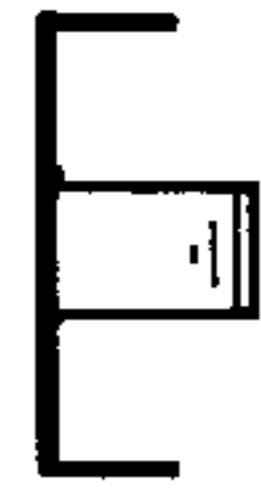

FIG. 7

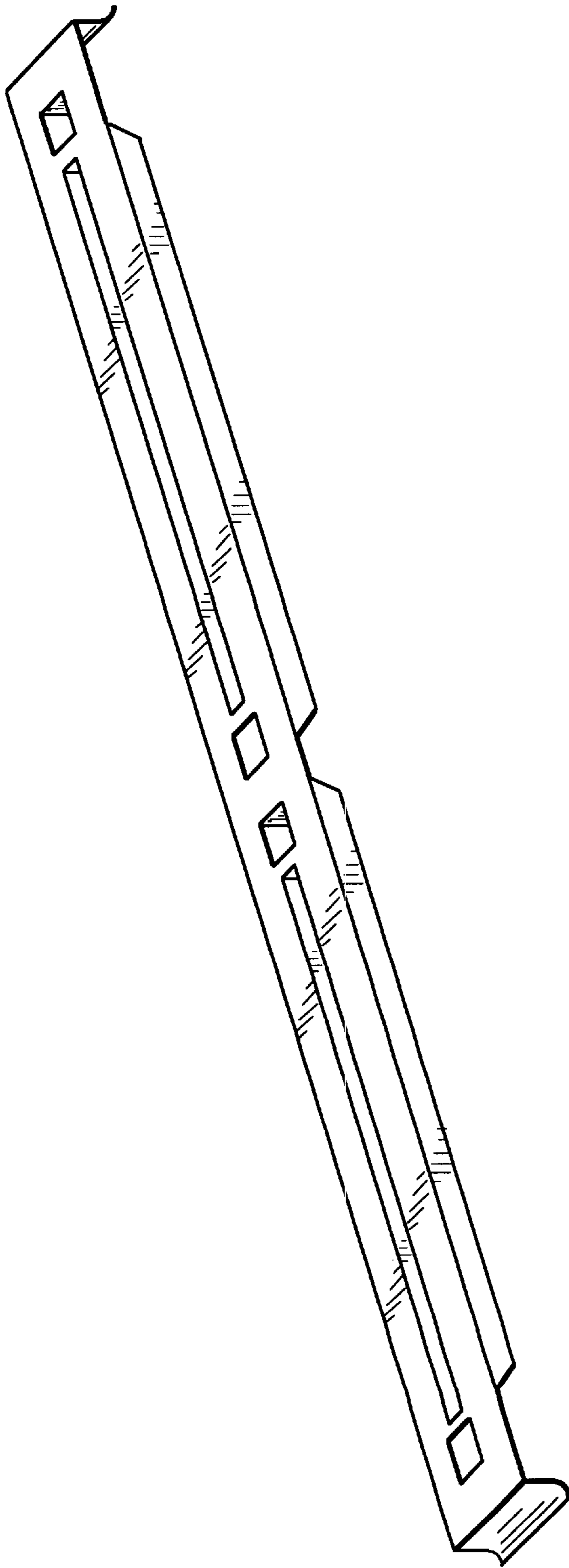

FIG. 8

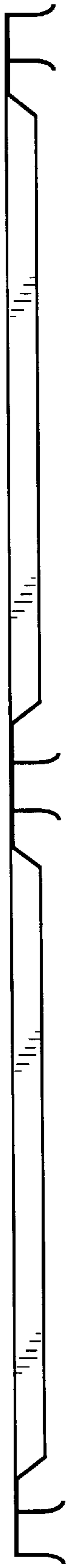

FIG. 9

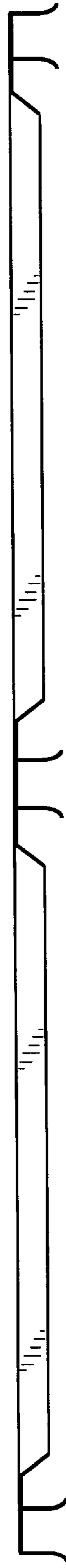

FIG. 10

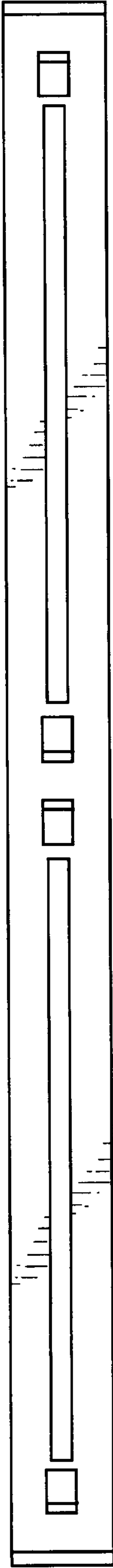

FIG. 11

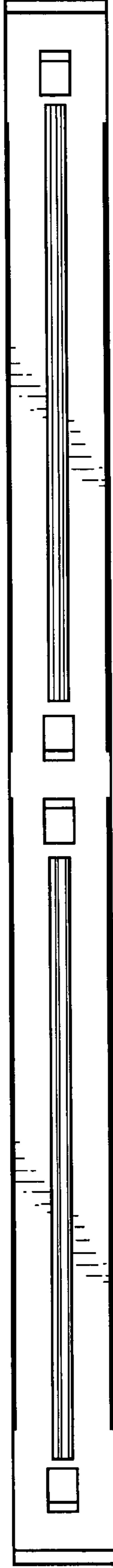

FIG. 12



FIG. 13



FIG. 14

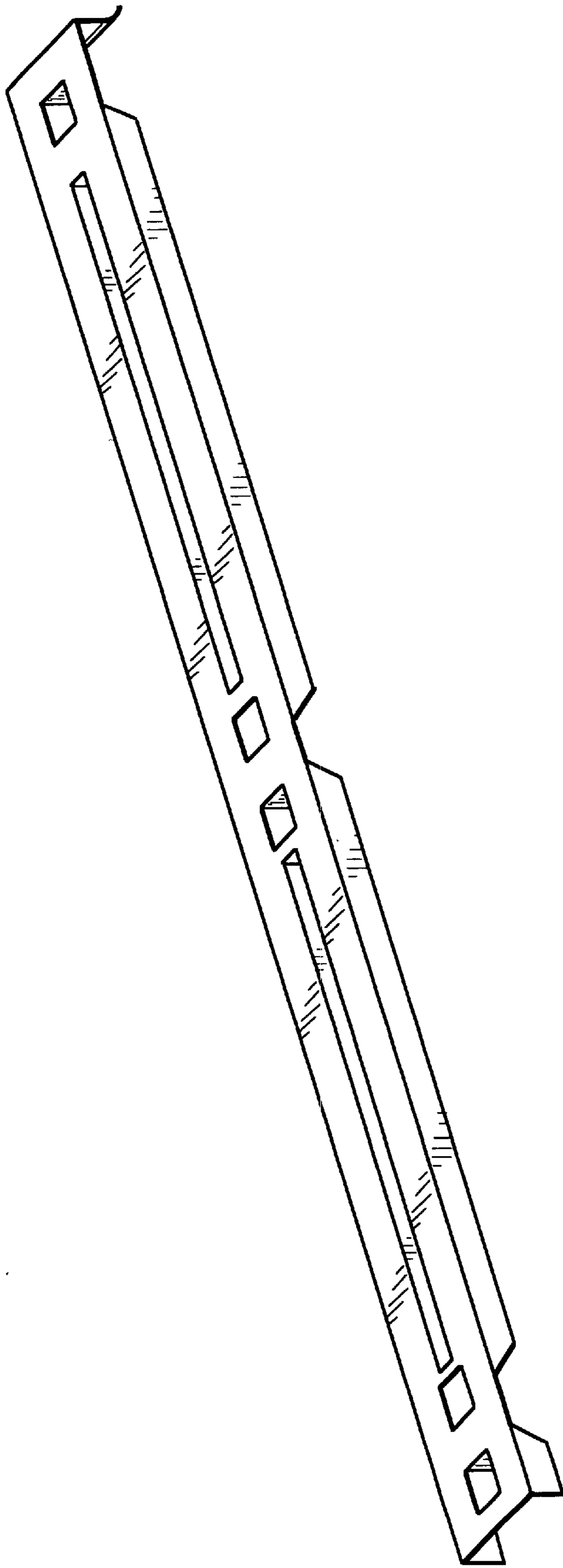

FIG. 15

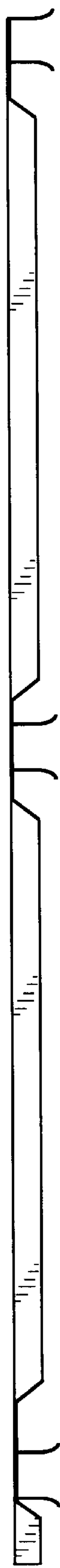

FIG. 16

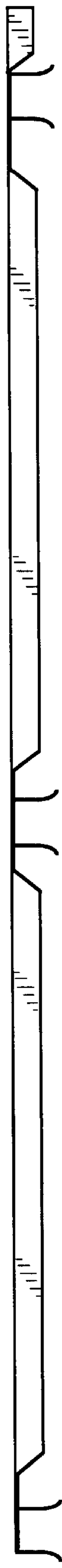

FIG. 17

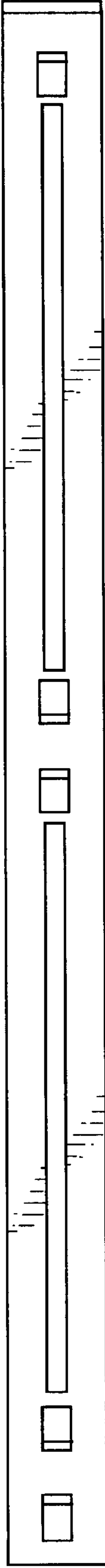

FIG. 18

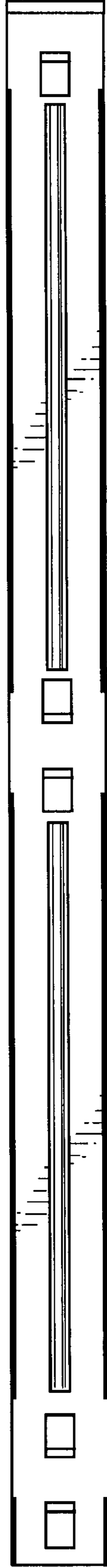

FIG. 19

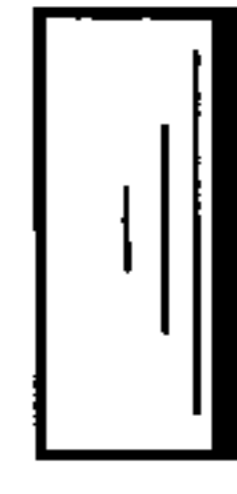

FIG. 20



FIG. 21