



US00D463488S

(12) **United States Design Patent**
Kramer et al.

(10) **Patent No.:** **US D463,488 S**

(45) **Date of Patent:** **** Sep. 24, 2002**

(54) **HIGHLIGHTER**

(76) Inventors: **Jeffrey A. Kramer**, 15959 NW. 15 Ave., Miami, FL (US) 33169; **William W. Rosenfeld**, 15959 NW. 15 Ave., Miami, FL (US) 33169

(**) Term: **14 Years**

(21) Appl. No.: **29/151,530**

(22) Filed: **Nov. 8, 2001**

(51) **LOC (7) Cl.** **19-06**

(52) **U.S. Cl.** **D19/36; D19/43**

(58) **Field of Search** D9/300, 337; D19/35, D19/36, 41-51, 53-58, 66, 81-85; 401/6, 7, 88, 29, 34, 35, 36, 52, 195, 202, 262

(56) **References Cited**

U.S. PATENT DOCUMENTS

D304,344 S	*	10/1989	Thatcher	D19/36
D306,315 S	*	2/1990	Shintani	D19/36
D316,272 S	*	4/1991	Lee	D19/42
D319,467 S	*	8/1991	Clowes	D19/36

D330,218 S	*	10/1992	Kimura	D19/66
D367,004 S	*	2/1996	Herbst et al.	D19/300
D389,518 S	*	1/1998	Reichmann	D19/36

* cited by examiner

Primary Examiner—Martie K. Holtje

(74) *Attorney, Agent, or Firm*—Malloy & Malloy, P.A.

(57) **CLAIM**

The ornamental design for a highlighter, as shown and described.

DESCRIPTION

FIG. 1 is a front perspective view illustrating our design for a highlighter;
FIG. 2 is a front view of our design;
FIG. 3 is a left side view of our design;
FIG. 4 is a top view of our design;
FIG. 5 is a right side view of our design;
FIG. 6 is a bottom view of our design;
FIG. 7 is a rear side view of our design; and,
FIG. 8 is an exploded perspective view of our design.

1 Claim, 3 Drawing Sheets

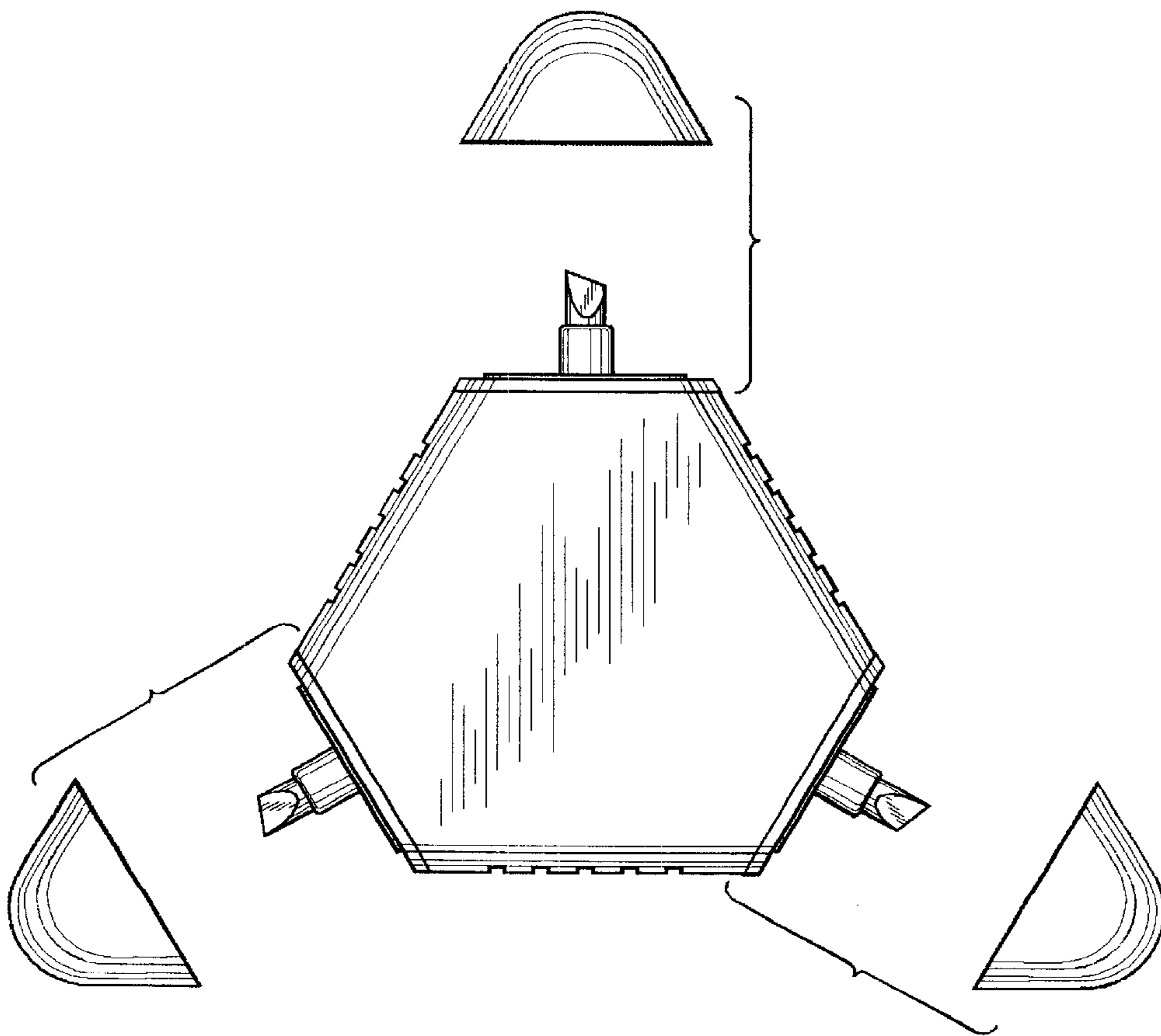

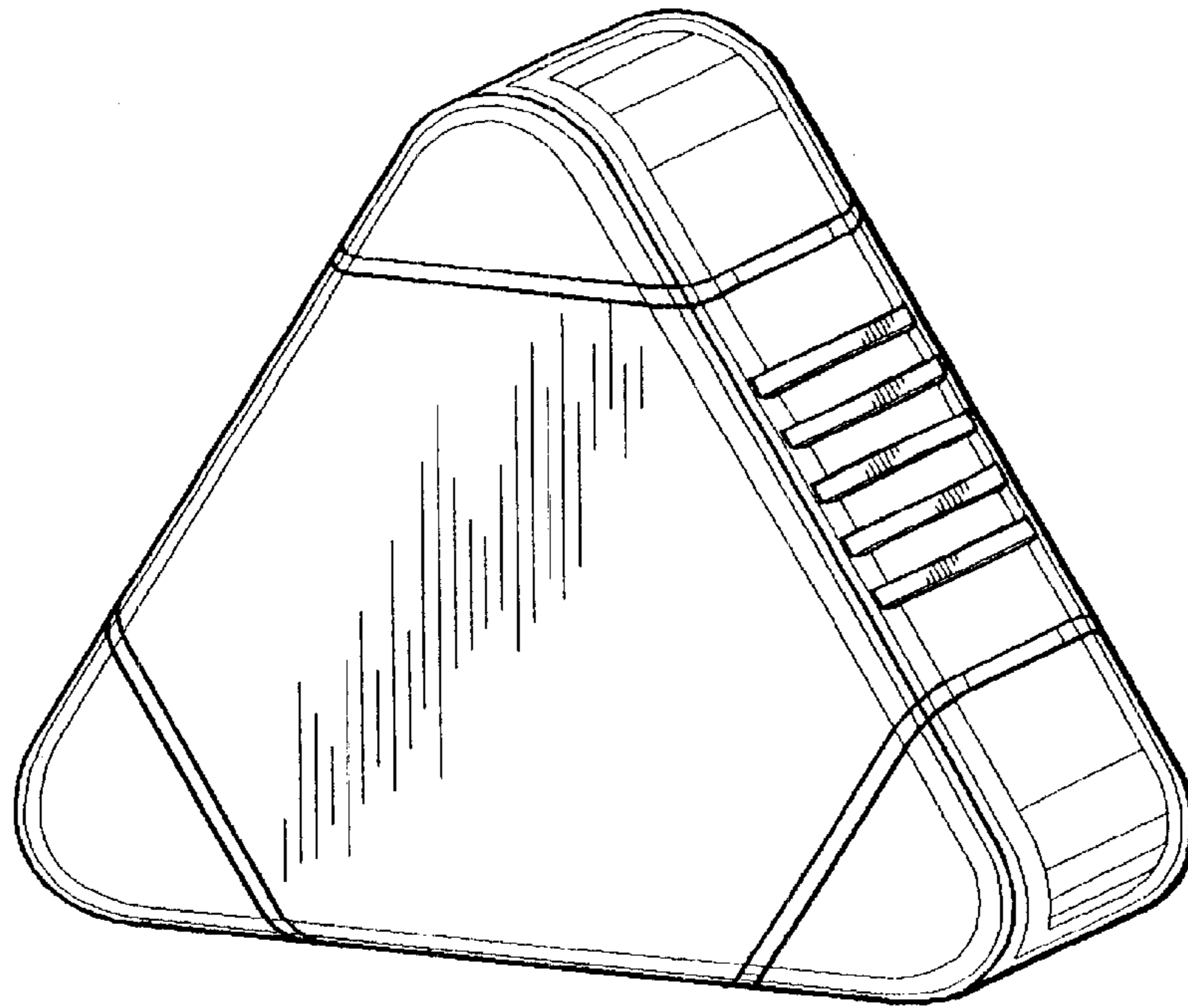

FIG. 1

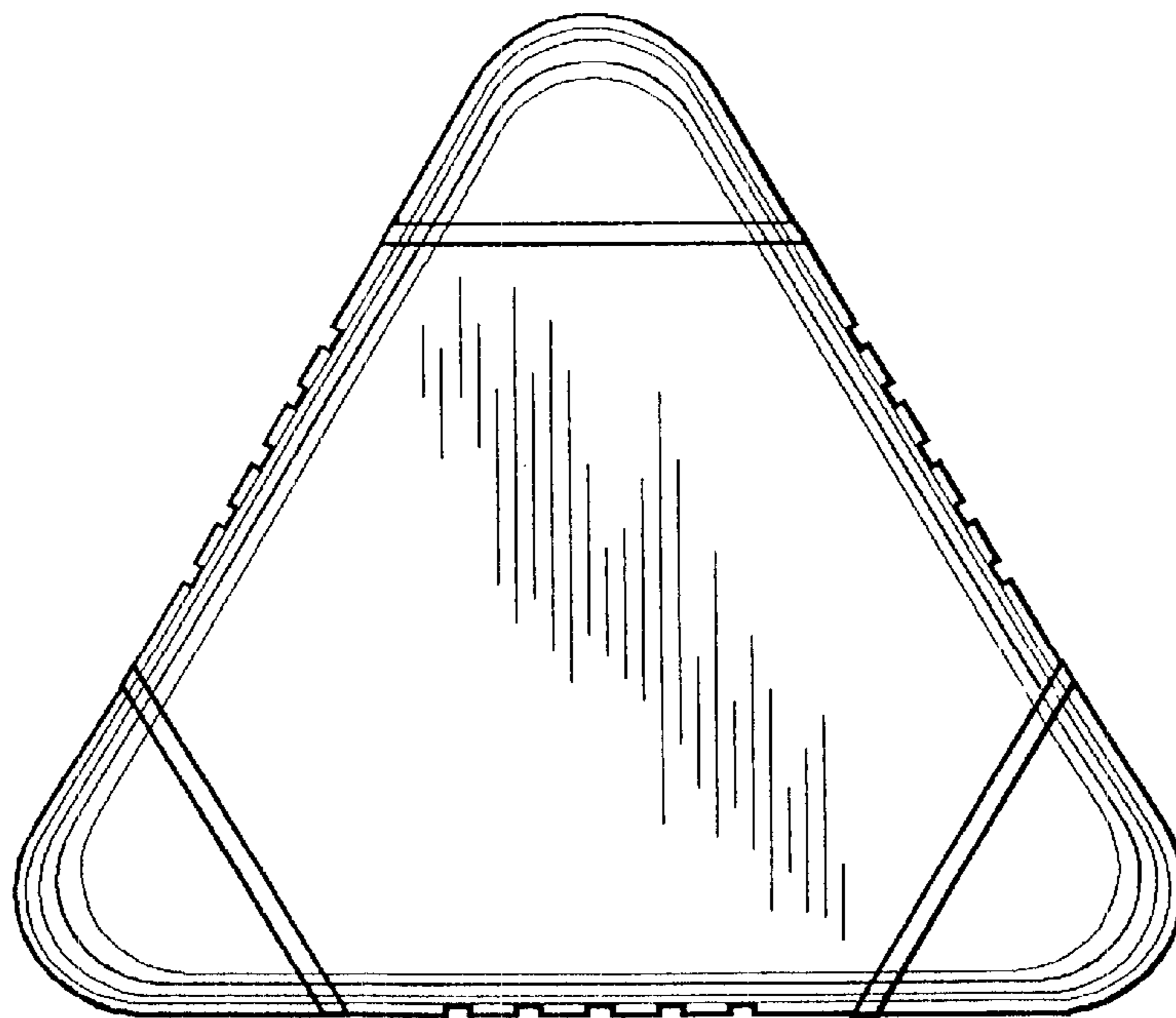

FIG. 7

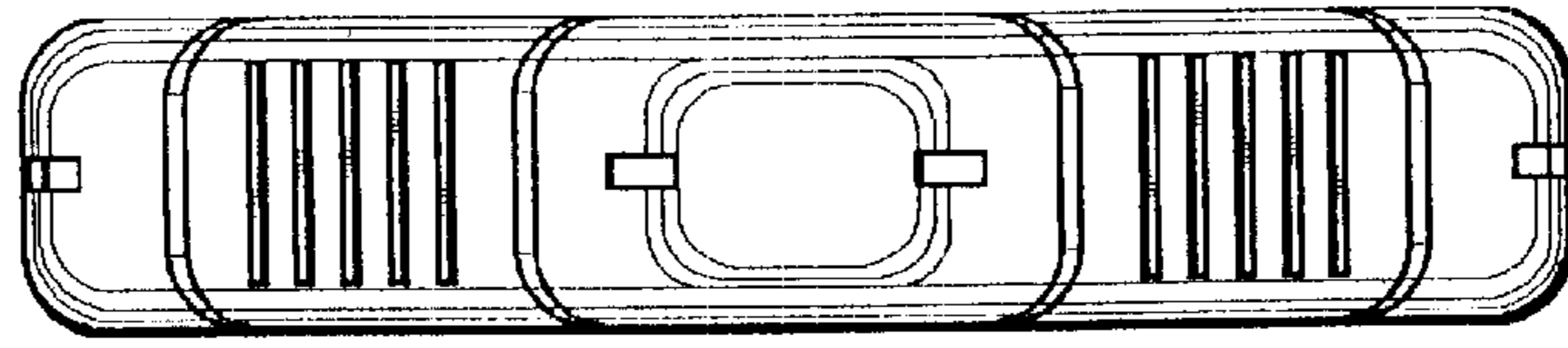

FIG. 4

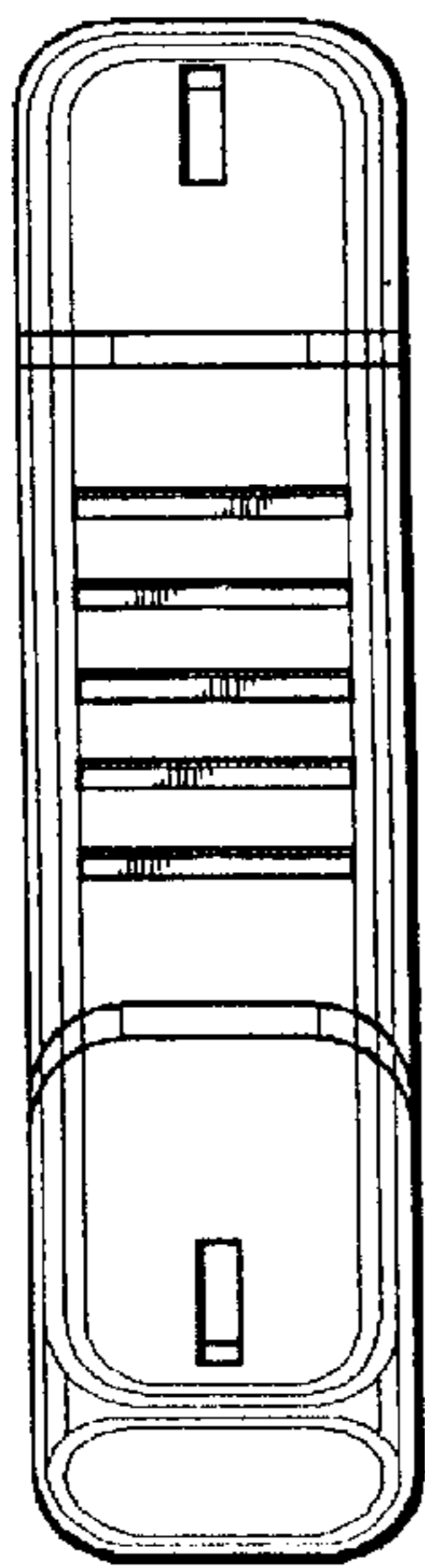

FIG. 3

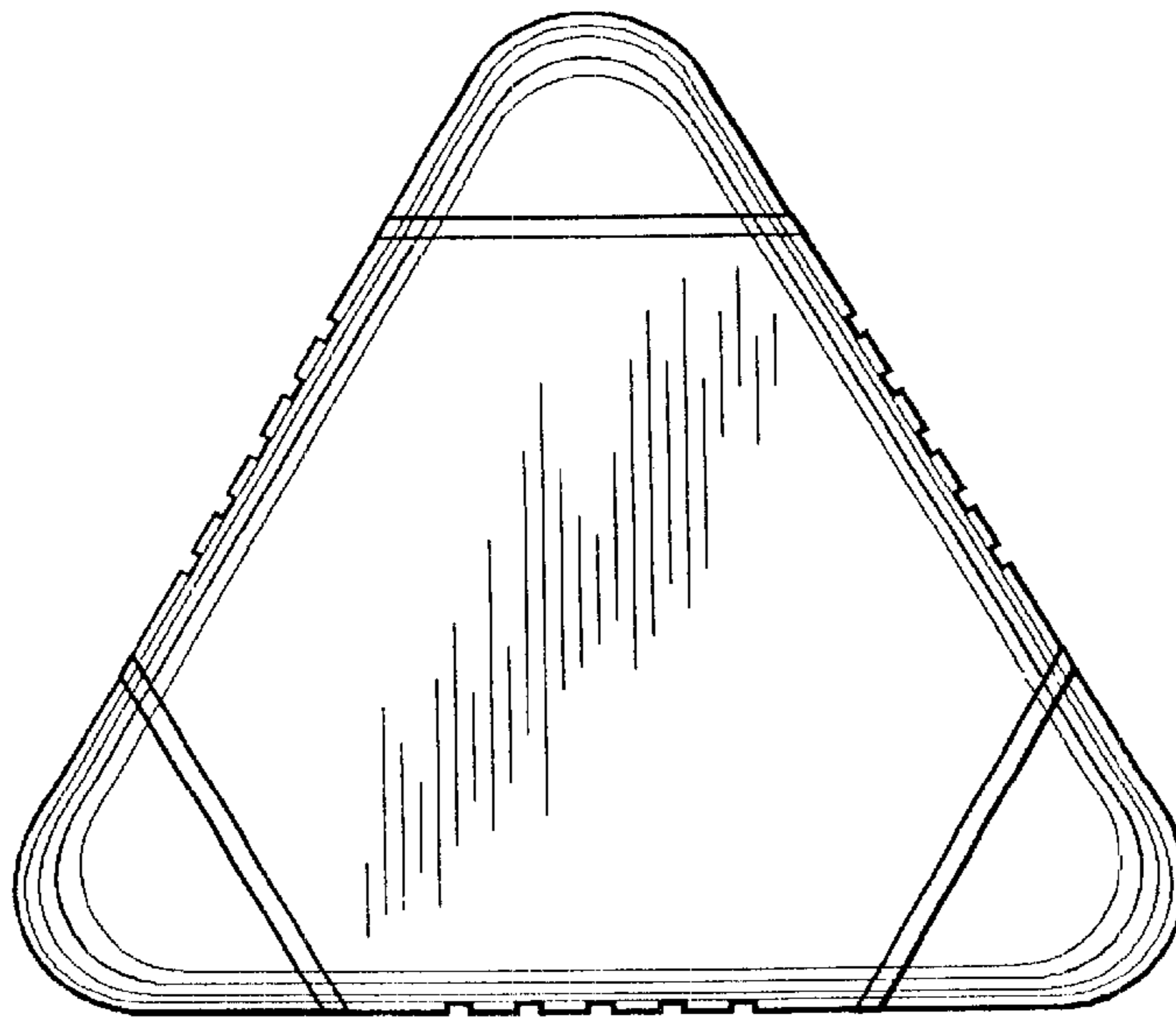

FIG. 2

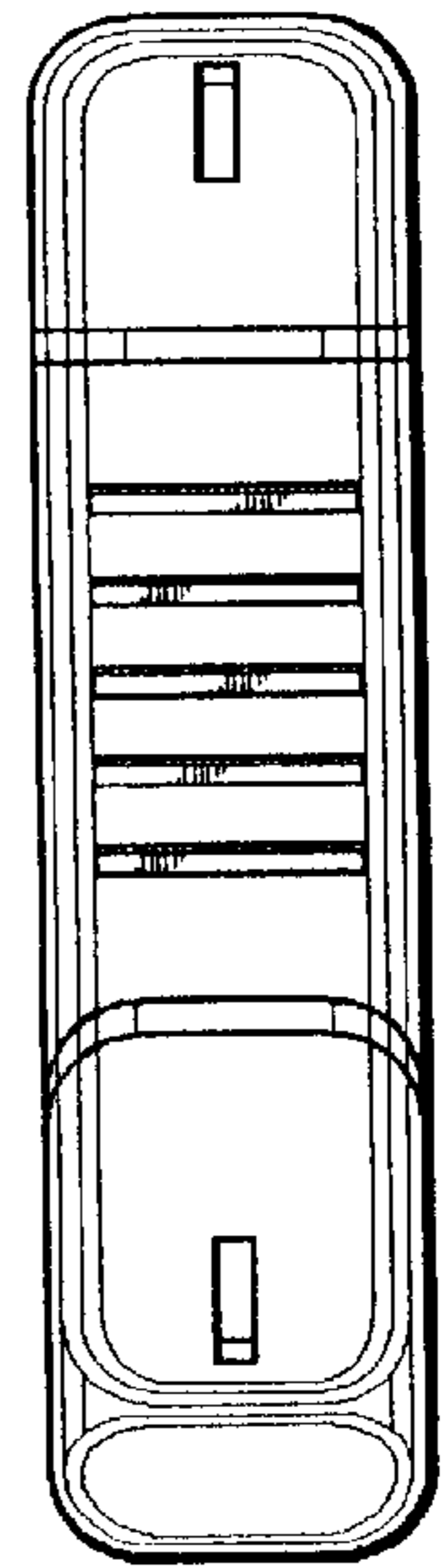

FIG. 5

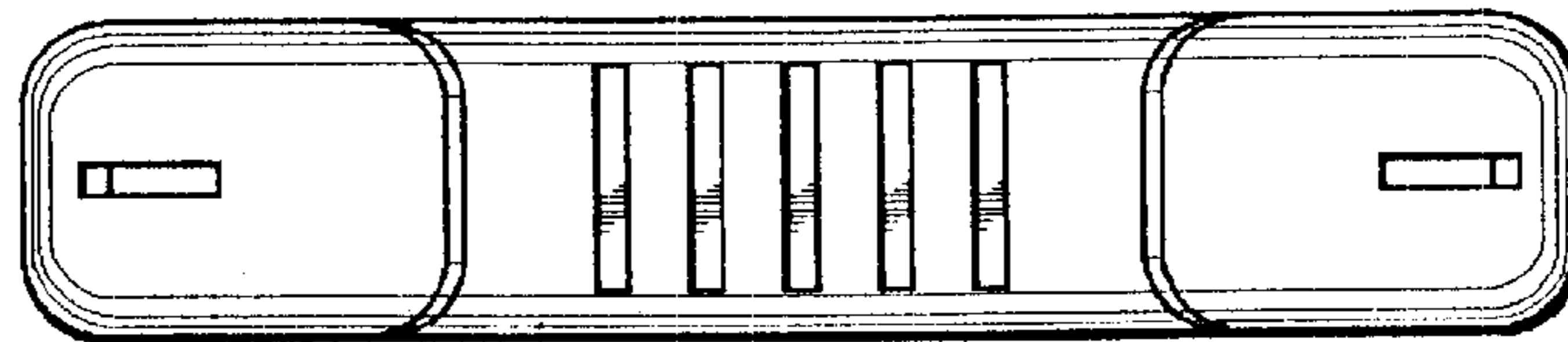

FIG. 6

