

US00D463468S

(12) **United States Design Patent** (10) **Patent No.:** **US D463,468 S**
Fujita et al. (45) **Date of Patent:** **** Sep. 24, 2002**

(54) **CAMERA**

(75) Inventors: **Yasushi Fujita**, Tokyo (JP); **Katsumi Endo**, Tokyo (JP); **Yoshiyasu Kubota**, Tokyo (JP); **Hajime Hattori**, Tokyo (JP); **Kuniko Nakamura**, Tokyo (JP); **Junko Fujisawa**, Tokyo (JP)

(73) Assignee: **Sony Corporation**, Tokyo (JP)

(**) Term: **14 Years**

(21) Appl. No.: **29/149,944**

(22) Filed: **Oct. 24, 2001**

(51) **LOC (7) Cl.** **16-01**

(52) **U.S. Cl.** **D16/202**

(58) **Field of Search** **D16/200–205,**
D16/208, 209, 218; 348/373–376; 396/535–541

(56) **References Cited**

U.S. PATENT DOCUMENTS

5,610,678	A	*	3/1997	Tsuboi et al.	396/373
D401,257	S	*	11/1998	Iino	D16/202
D412,003	S	*	7/1999	Sumida et al.	D16/202
D421,597	S		3/2000	Oba et al.	D13/182
D421,967	S		3/2000	Oba et al.	D13/182
D427,159	S		6/2000	Oba et al.	D13/182
D432,505	S		10/2000	Oba et al.	D13/182
D445,441	S	*	7/2001	Liu	D16/202
D448,785	S	*	10/2001	Chou	D16/202

OTHER PUBLICATIONS

Global Sources webpage, Kocom KDC-120 digital camera, 2001.*

ACTCO products webpage, Pen Cam digital camera, 2001.*

* cited by examiner

Primary Examiner—Adir Aronovich
(74) *Attorney, Agent, or Firm*—Rader, Fishman & Grauer, PLLC

(57) **CLAIM**

The ornamental design for a camera, as shown and described.

DESCRIPTION

FIG. 1 is a perspective view of a camera showing our new design;

FIG. 2 is a front elevational view thereof;

FIG. 3 is a rear elevational view thereof;

FIG. 4 is a left side elevational view thereof;

FIG. 5 is a right side elevational view thereof;

FIG. 6 is a top plan view thereof; and

FIG. 7 is a bottom plan view thereof.

FIG. 8 is a second embodiment perspective view of a camera showing our new design;

FIG. 9 is a front elevational view thereof;

FIG. 10 is a rear elevational view thereof;

FIG. 11 is a left side elevational view thereof;

FIG. 12 is a right side elevational view thereof;

FIG. 13 is a top plan view thereof; and,

FIG. 14 is a bottom plan view thereof.

1 Claim, 8 Drawing Sheets

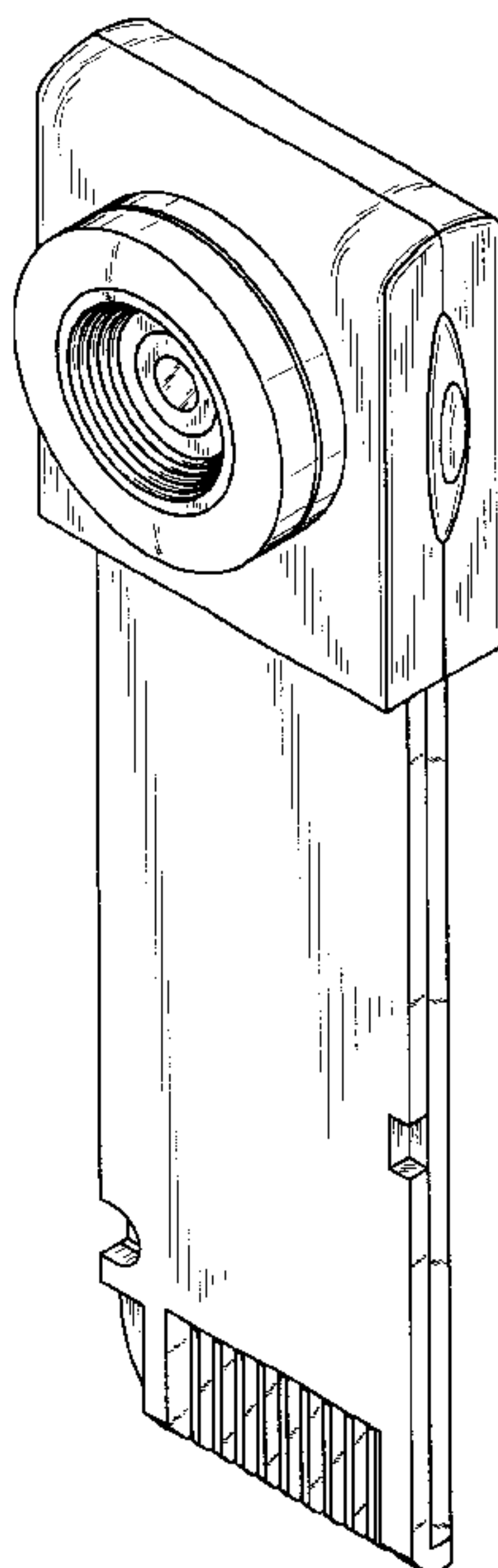

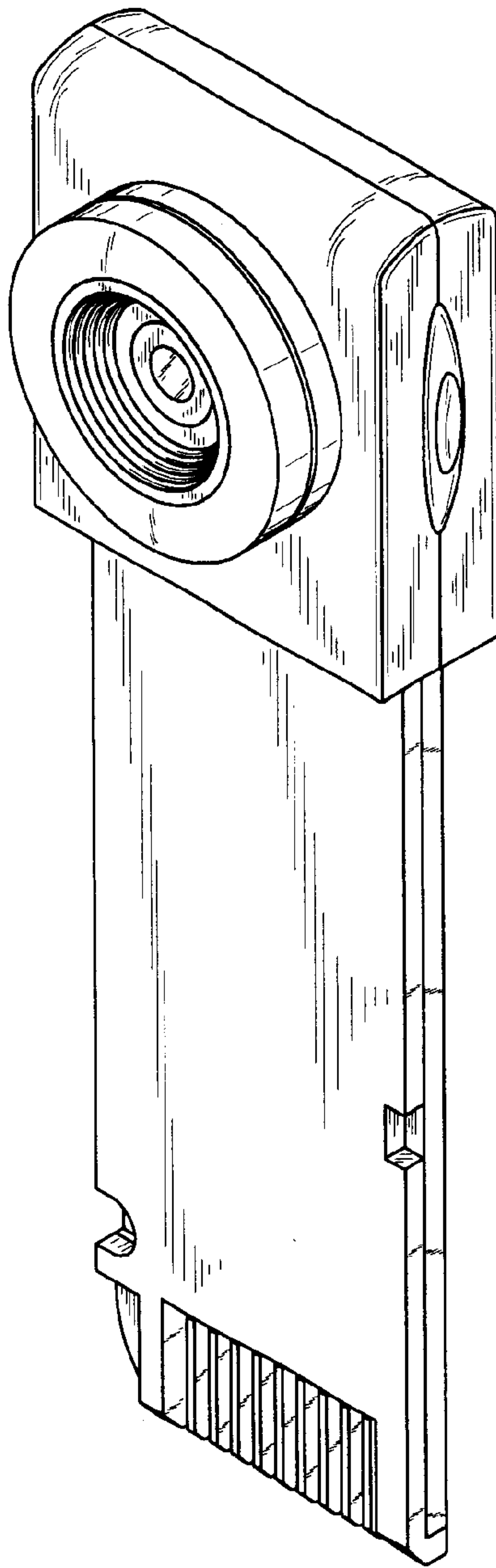

Fig. 1

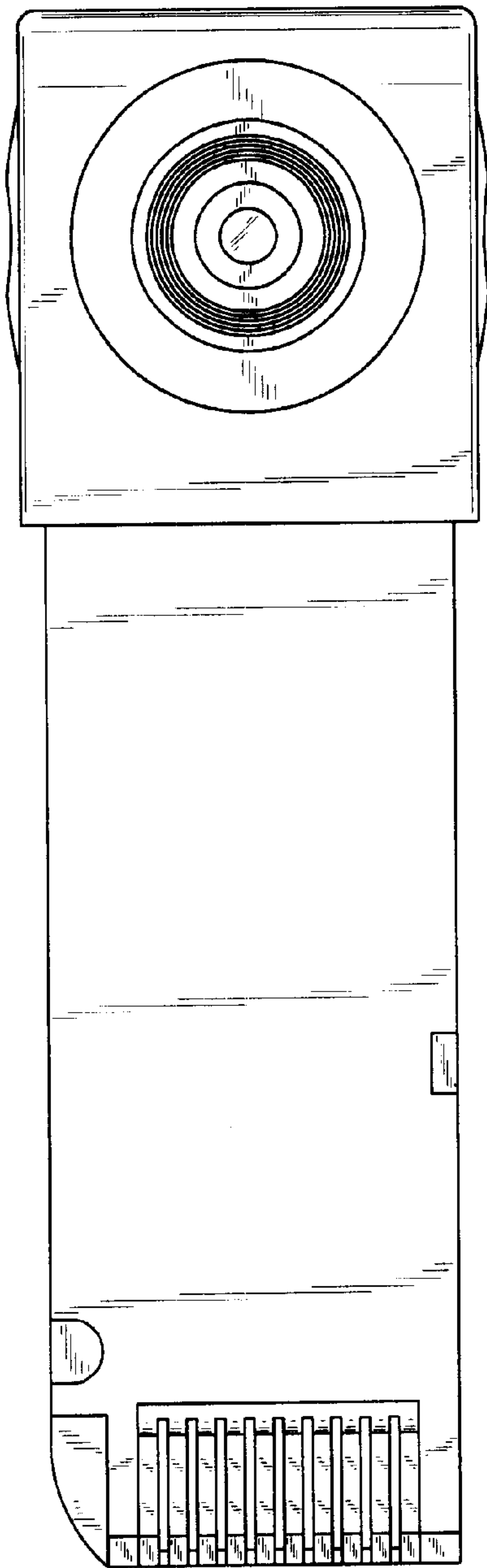

Fig. 2

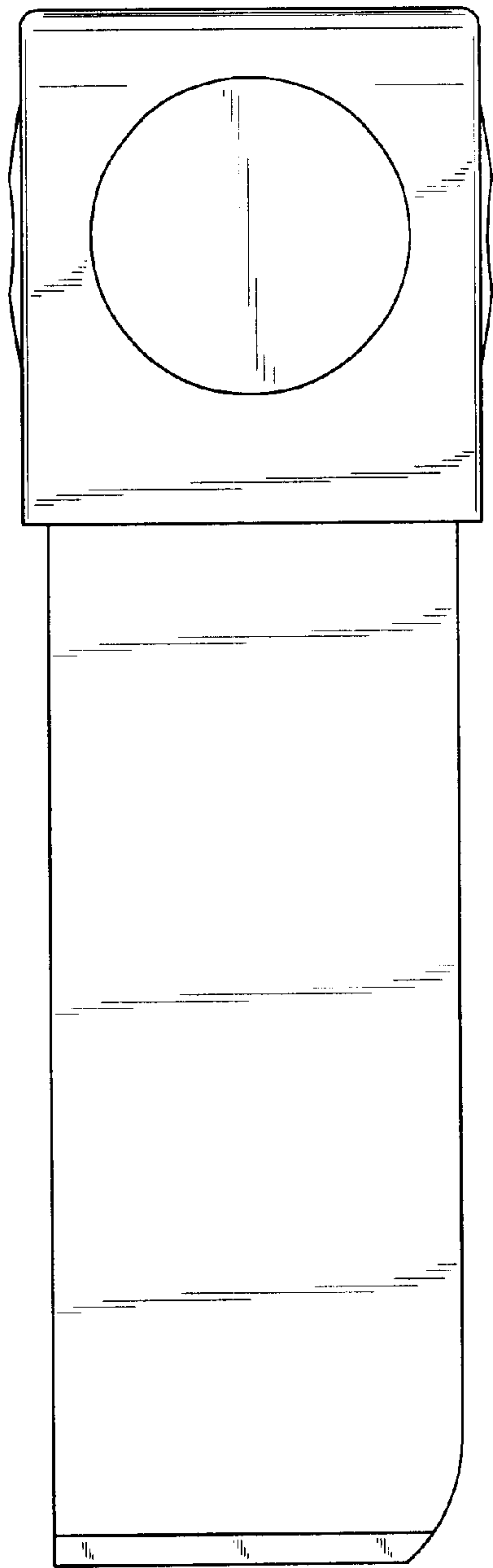

Fig. 3

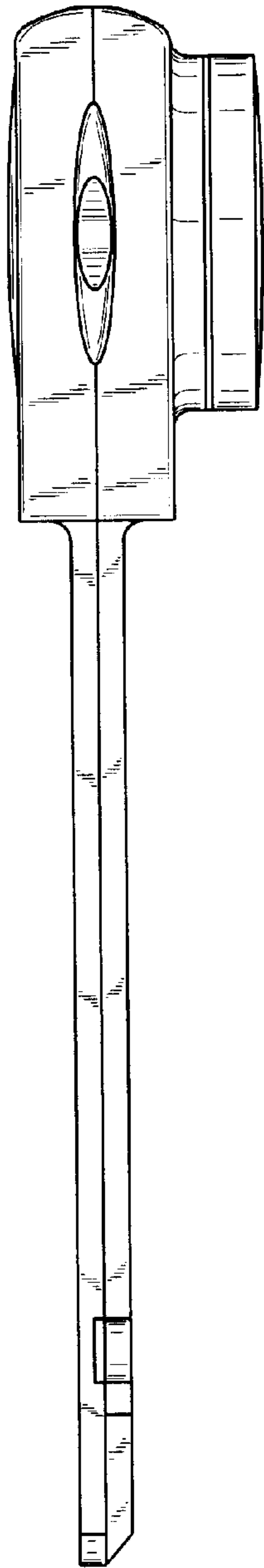

Fig. 4

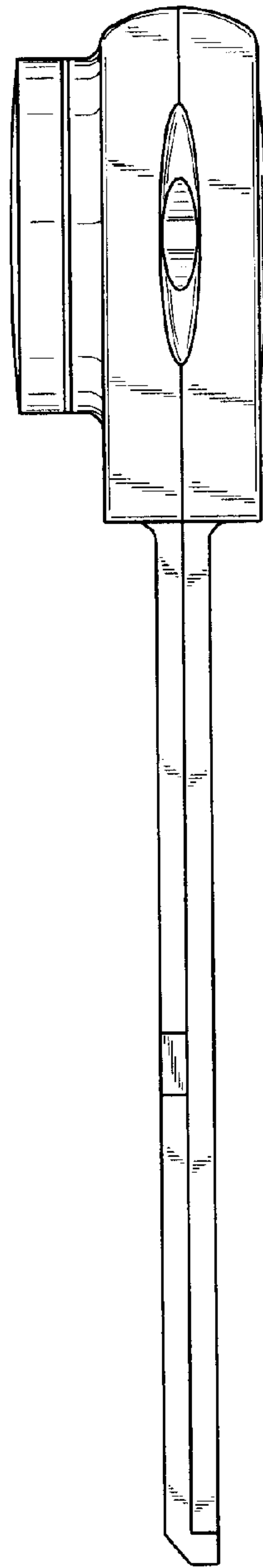

Fig. 5

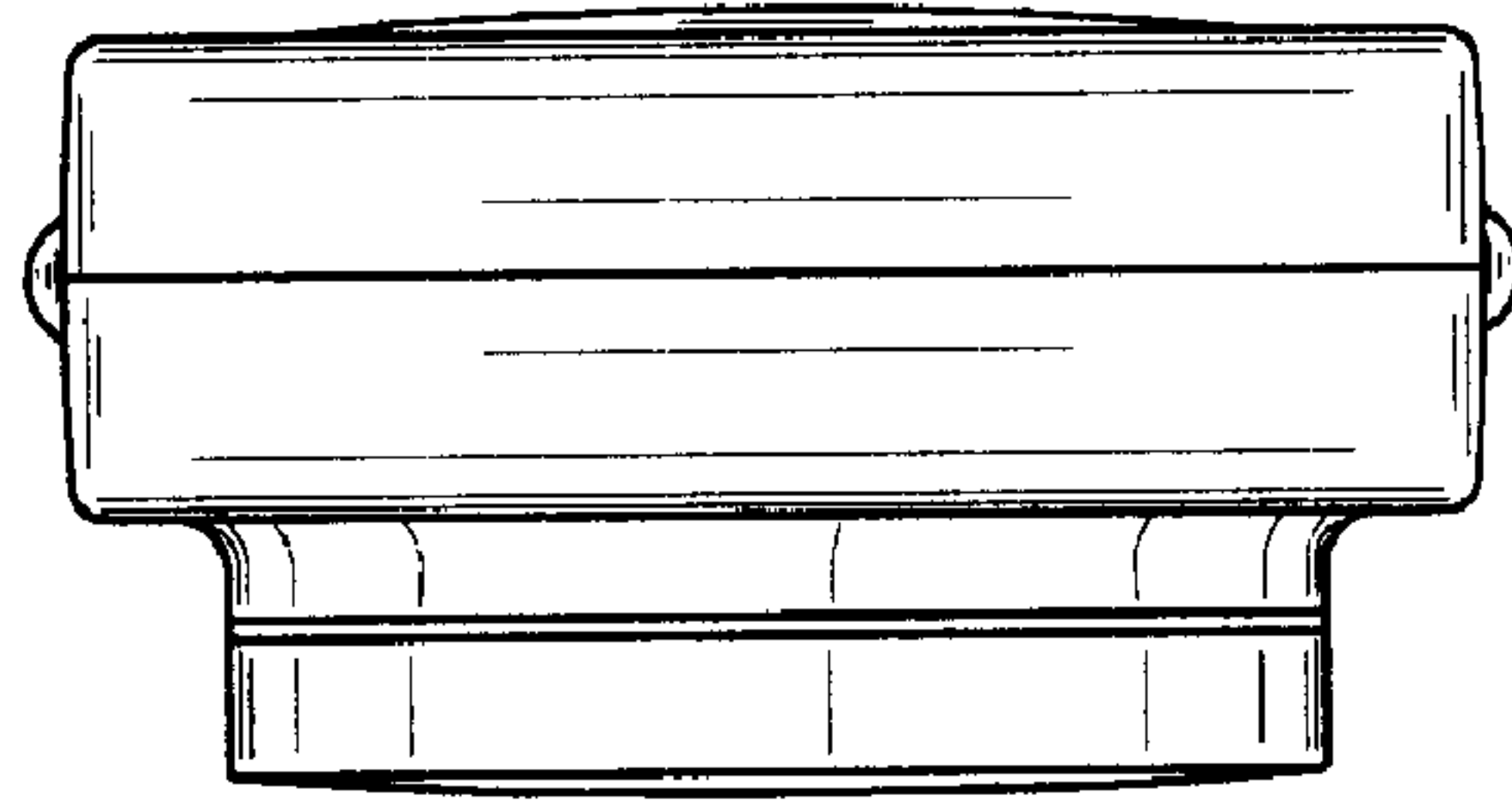

Fig. 6

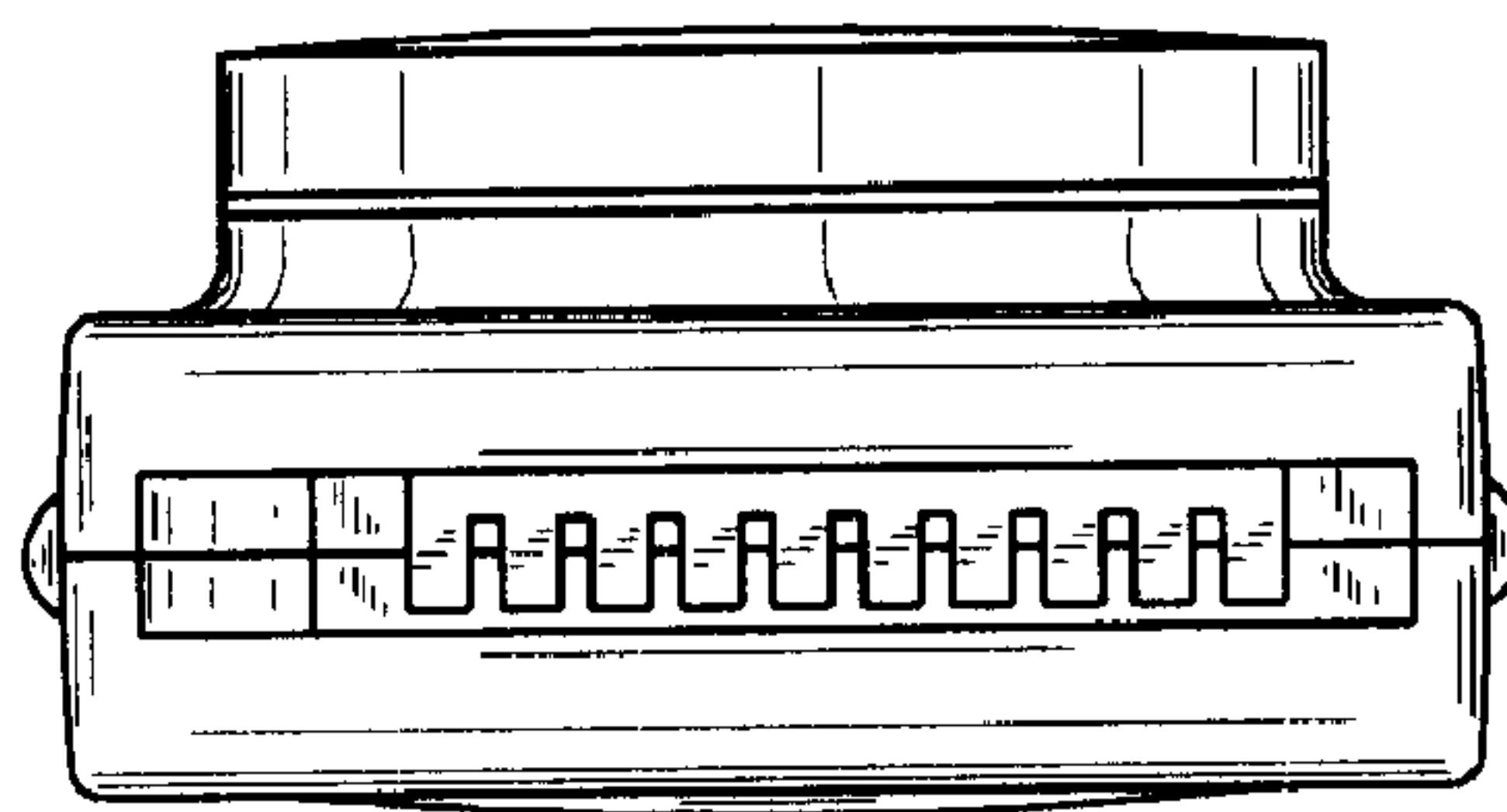

Fig. 7

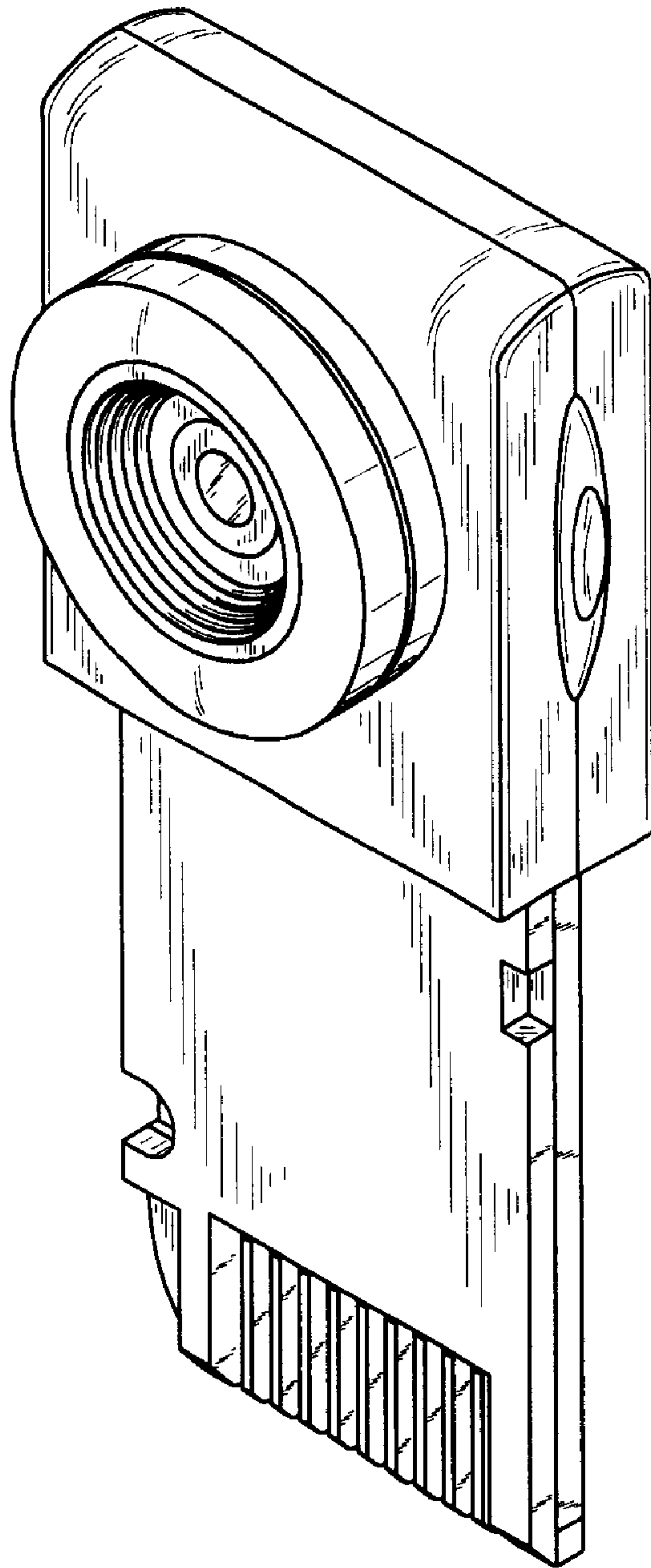

Fig. 8

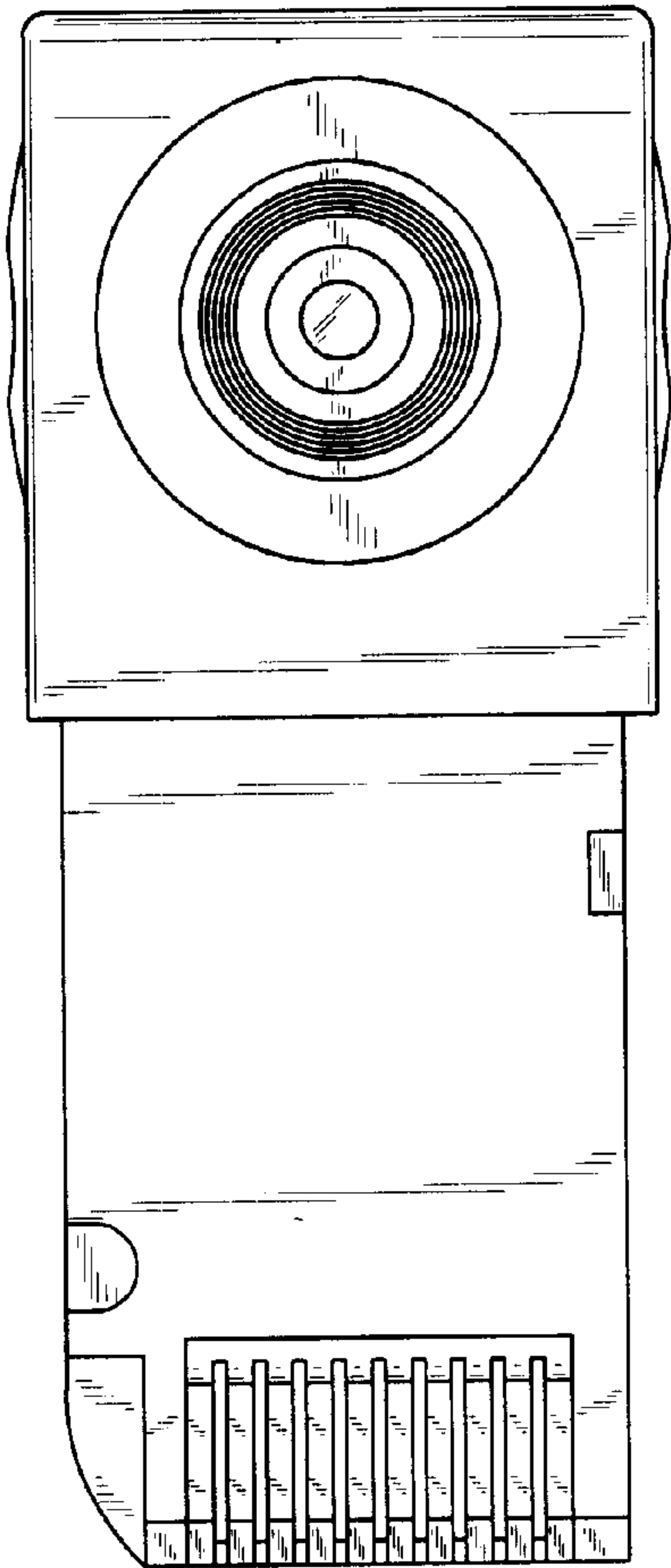

Fig. 9

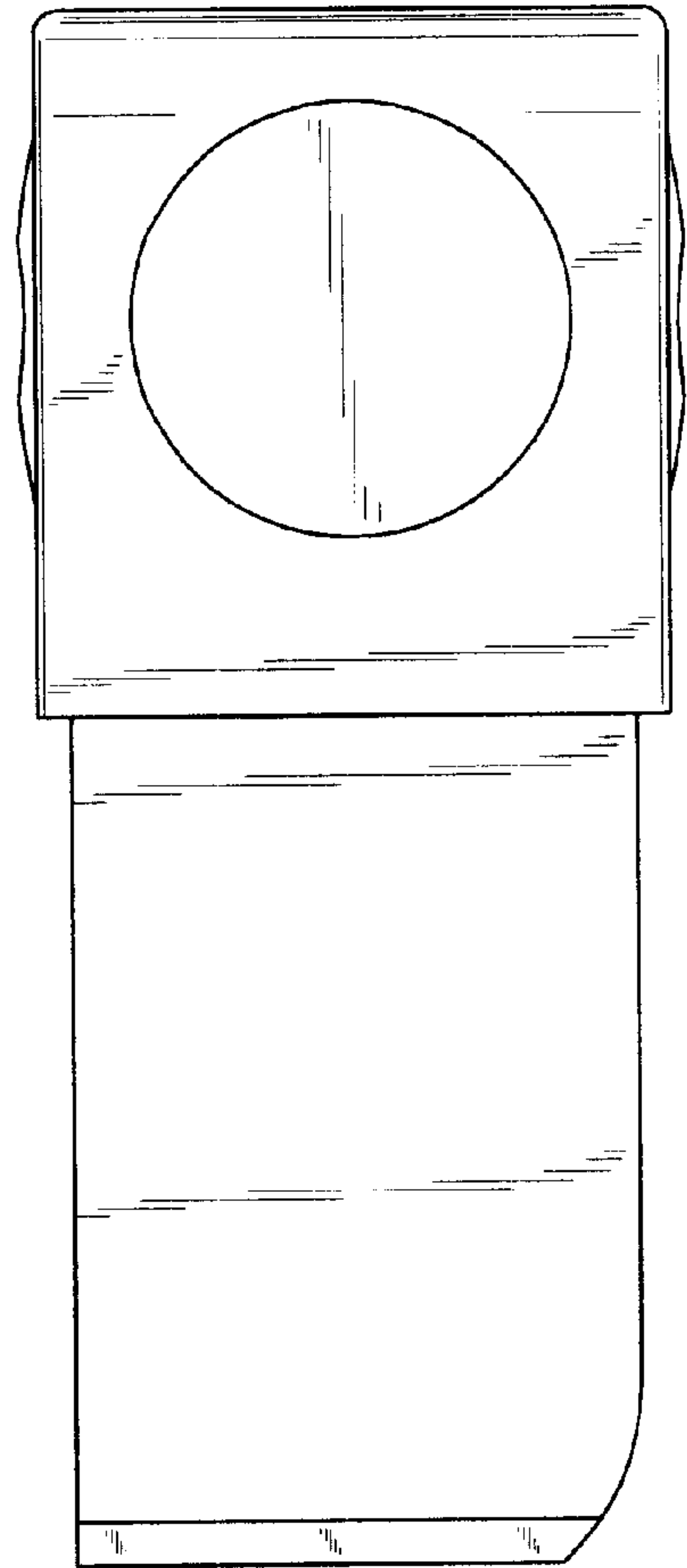

Fig. 10

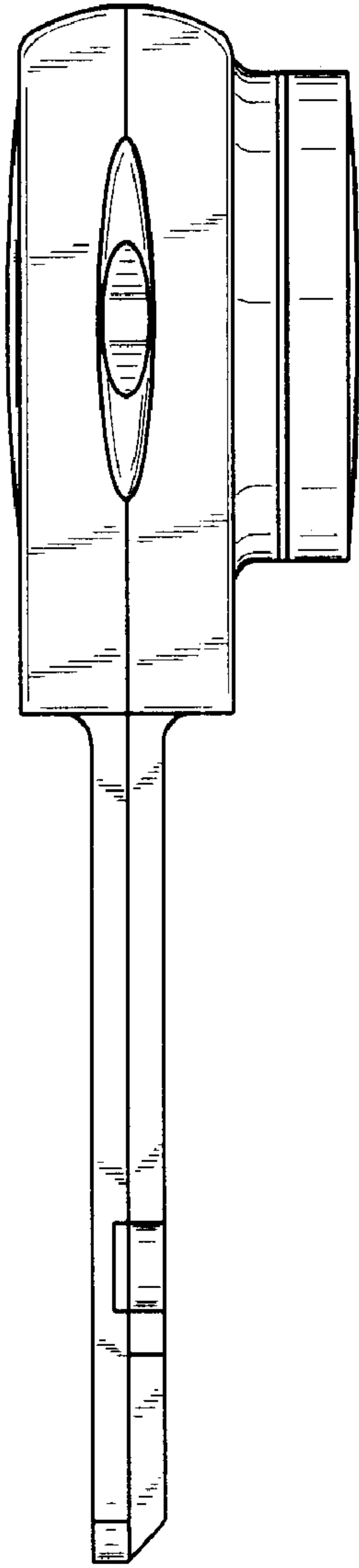

Fig. 11

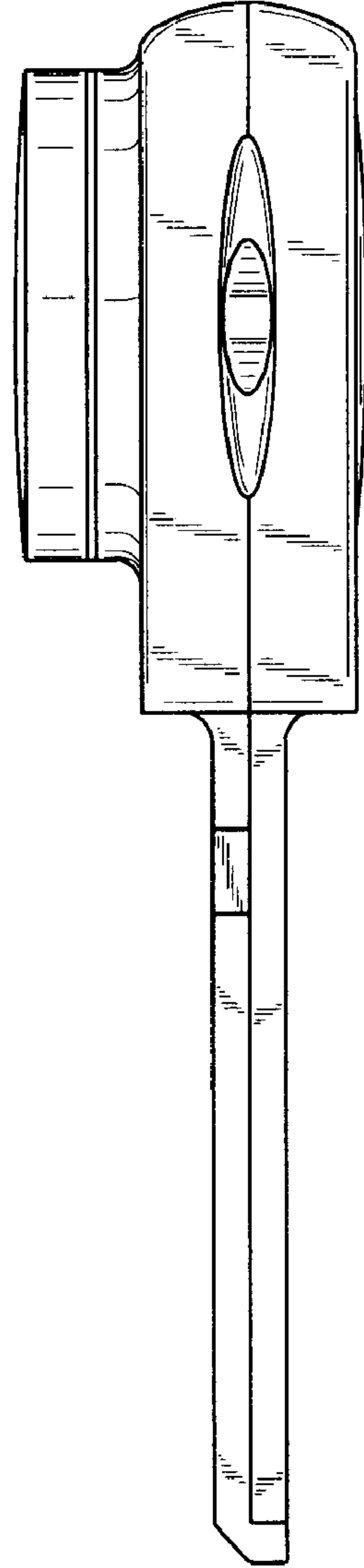

Fig. 12

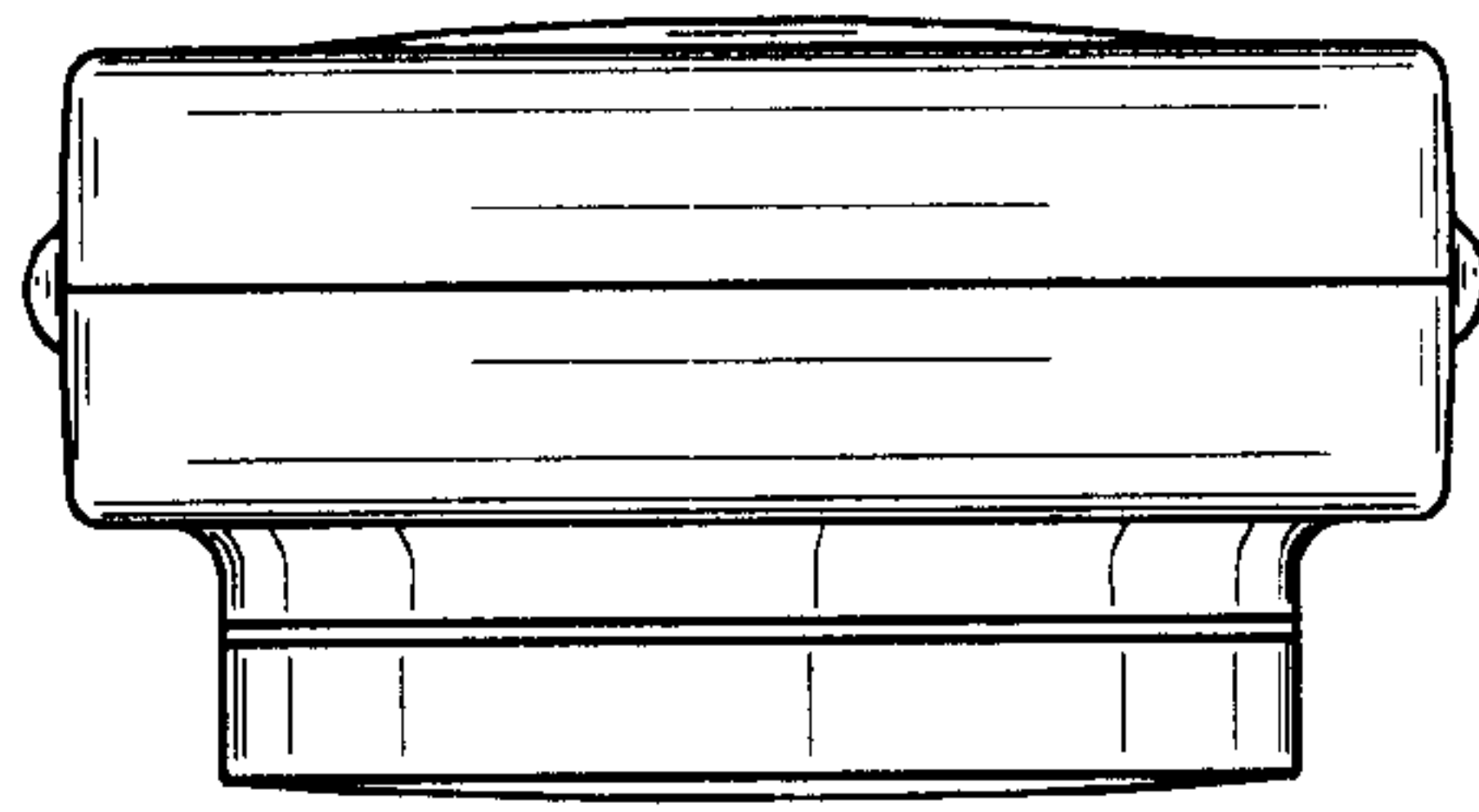

Fig. 13

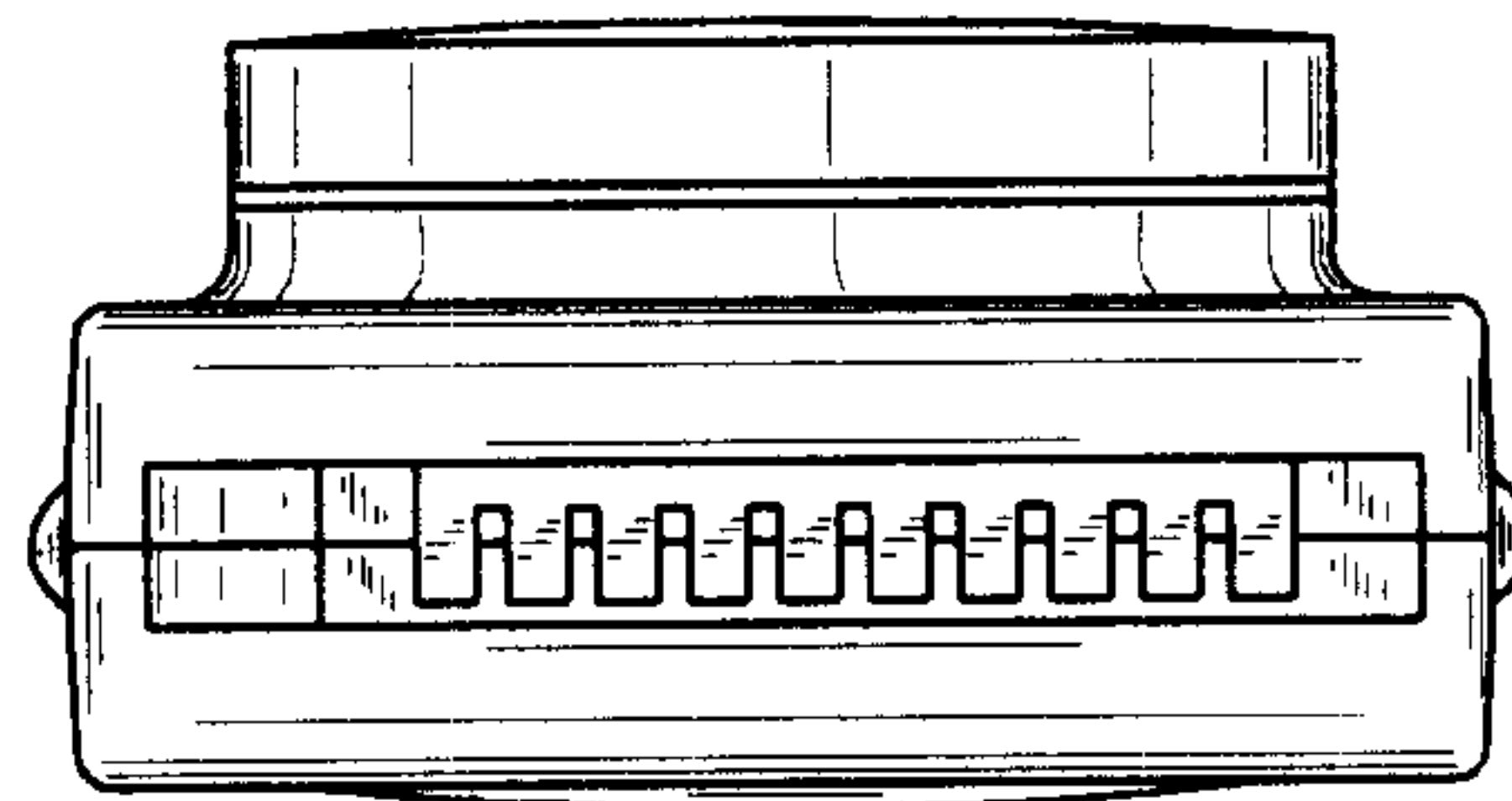

Fig. 14