

US00D463368S

(12) **United States Design Patent**
Demshki

(10) **Patent No.:** **US D463,368 S**

(45) **Date of Patent:** **** Sep. 24, 2002**

(54) **SURGE PROTECTOR MODULE**

(75) Inventor: **Robert Demshki**, Cherryville, NC (US)

(73) Assignee: **JJI Lighting Group, Inc.**, Greenwich, CT (US)

(**) Term: **14 Years**

(21) Appl. No.: **29/133,925**

(22) Filed: **Dec. 12, 2000**

(51) **LOC (7) Cl.** **13-03**

(52) **U.S. Cl.** **D13/139.8**

(58) **Field of Search** D13/139.4, 139.6-139.8;
174/48, 49, 53, 58; 439/131, 135, 638,
650-654

(56) **References Cited**

U.S. PATENT DOCUMENTS

D397,089 S * 8/1998 Gargano D13/139.8
D432,989 S * 10/2000 Rossman et al. D13/139.6 X
D443,249 S * 6/2001 Lee D13/139.8

* cited by examiner

Primary Examiner—Jennifer Rivard

(74) *Attorney, Agent, or Firm*—Fitzpatrick, Cella, Harper & Scinto

(57) **CLAIM**

The ornamental design for a surge protector module, as shown and described.

DESCRIPTION

FIG. 1 is a perspective view of a surge protector module showing my new design;

FIG. 2 is a front elevational view;

FIG. 3 is a side elevational view thereof;

FIG. 4 is a rear elevational view thereof;

FIG. 5 is a view of the opposite side thereof;

FIG. 6 is a top view thereof;

FIG. 7 is a bottom view thereof; and,

FIG. 8 is an exploded front perspective view showing the removable facia.

The broken line environmental showing is for illustrative purposes only and forms no part of the claimed design.

1 Claim, 4 Drawing Sheets

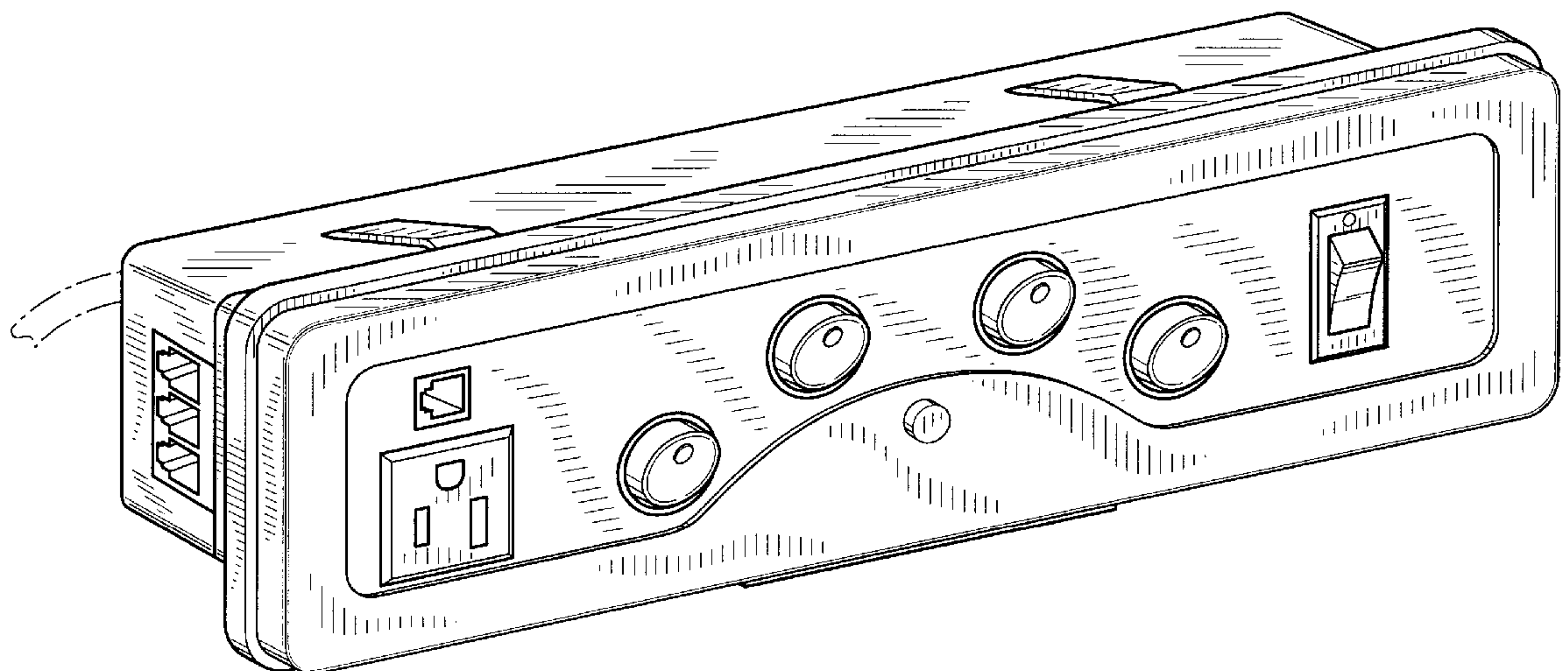

FIG. 1

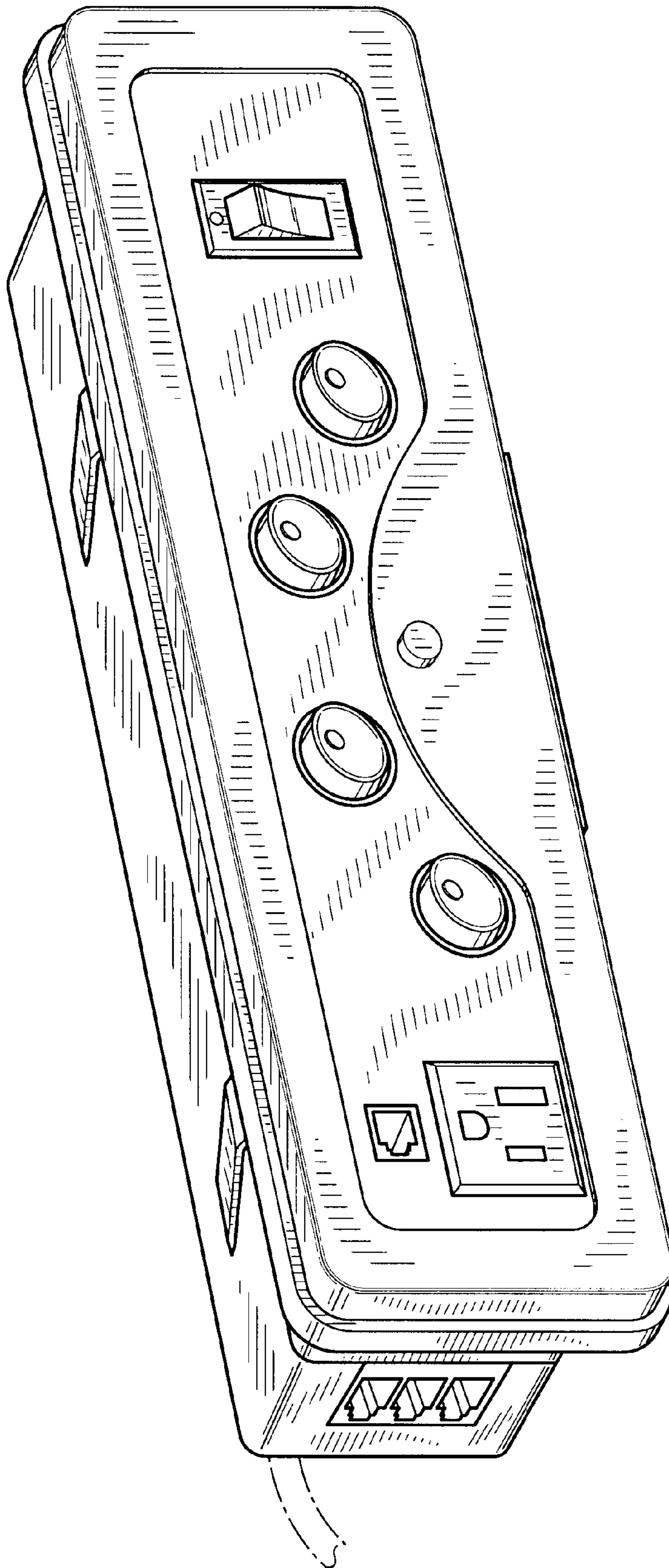

FIG. 2

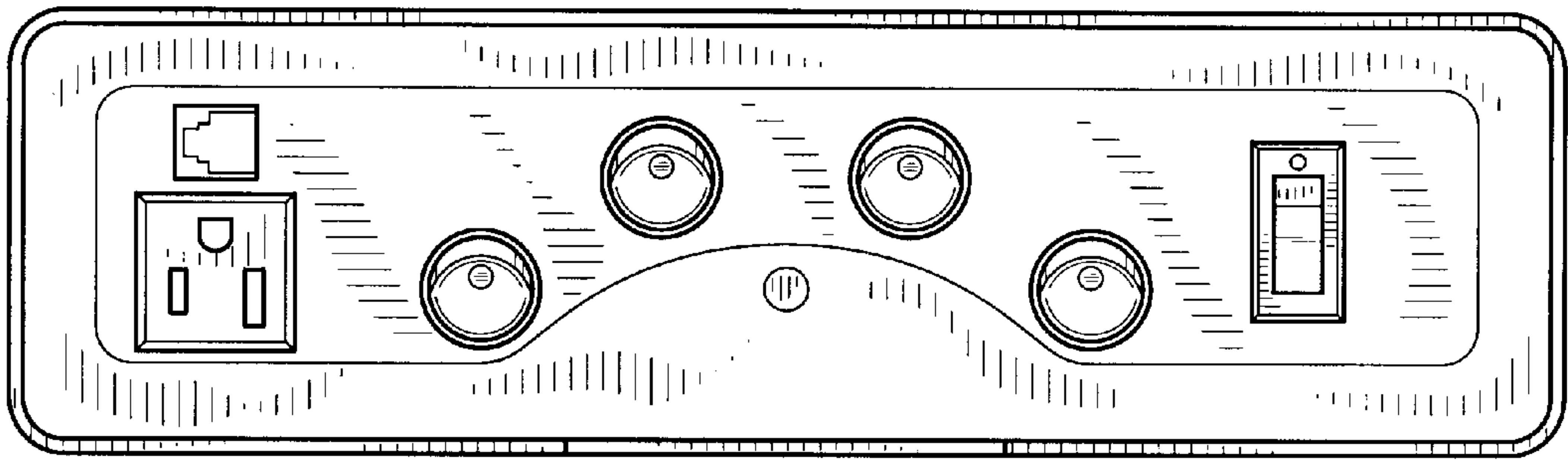

FIG. 3

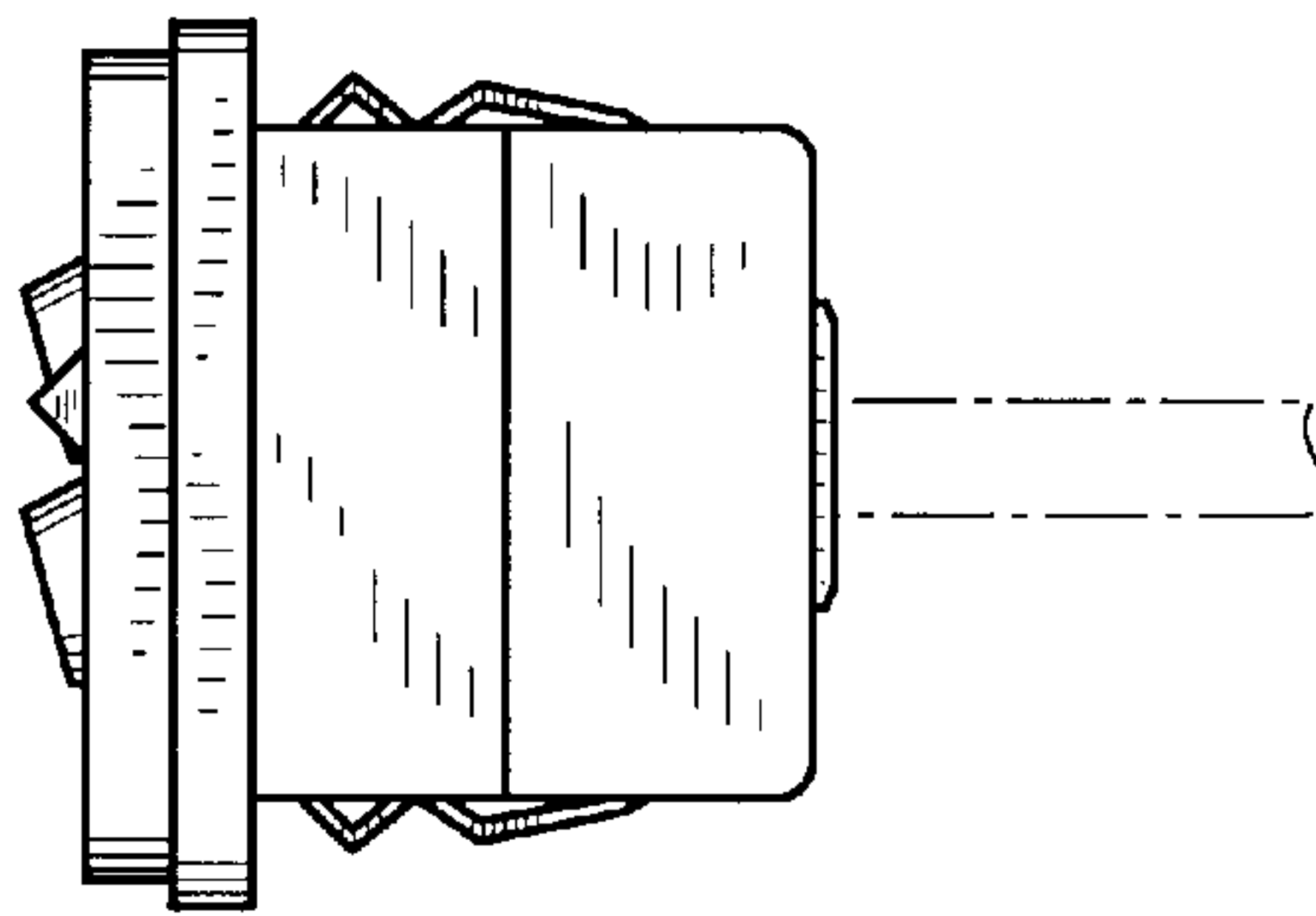

FIG. 4

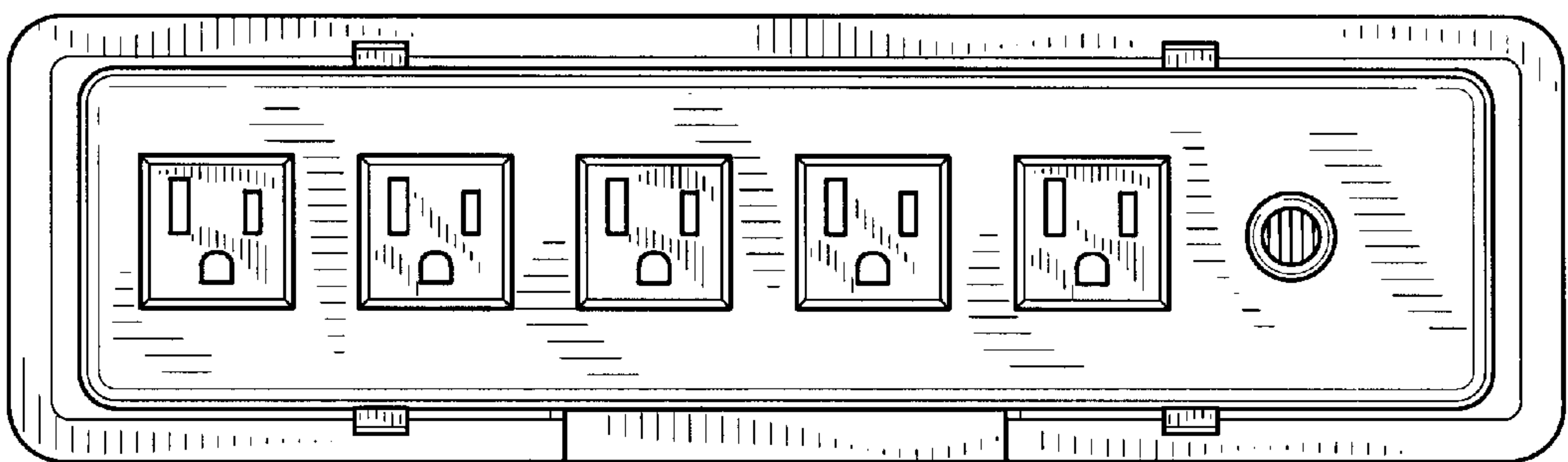

FIG. 5

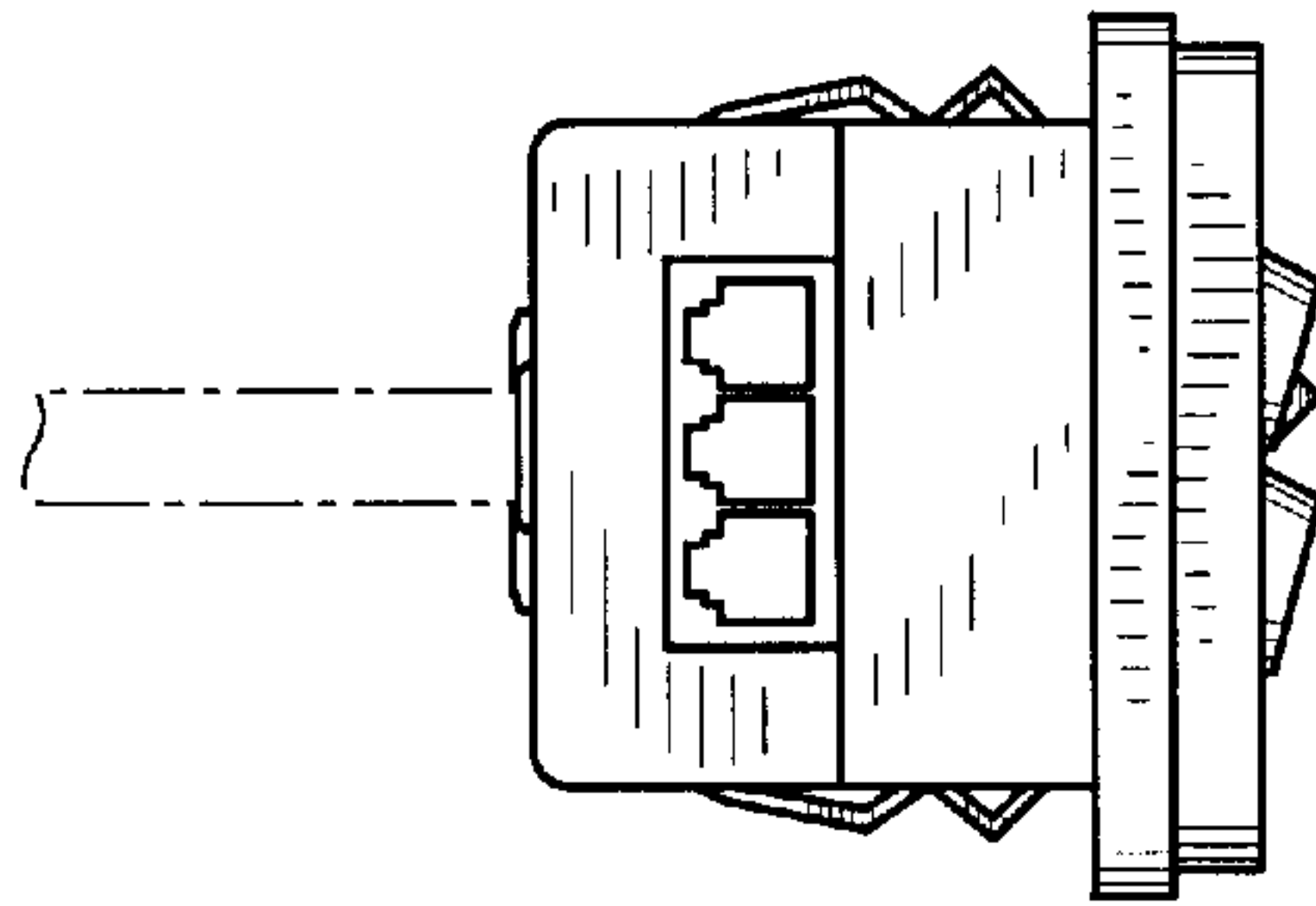

FIG. 6

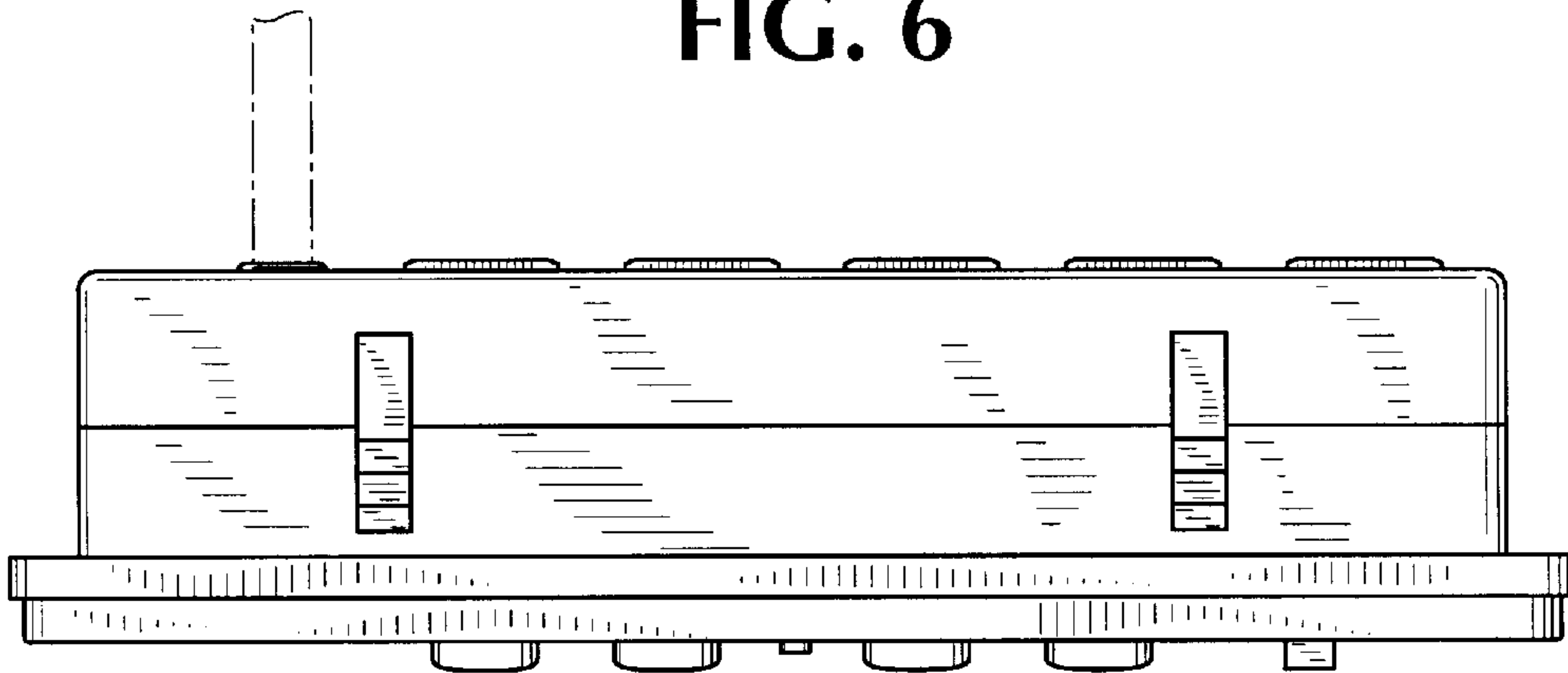

FIG. 7

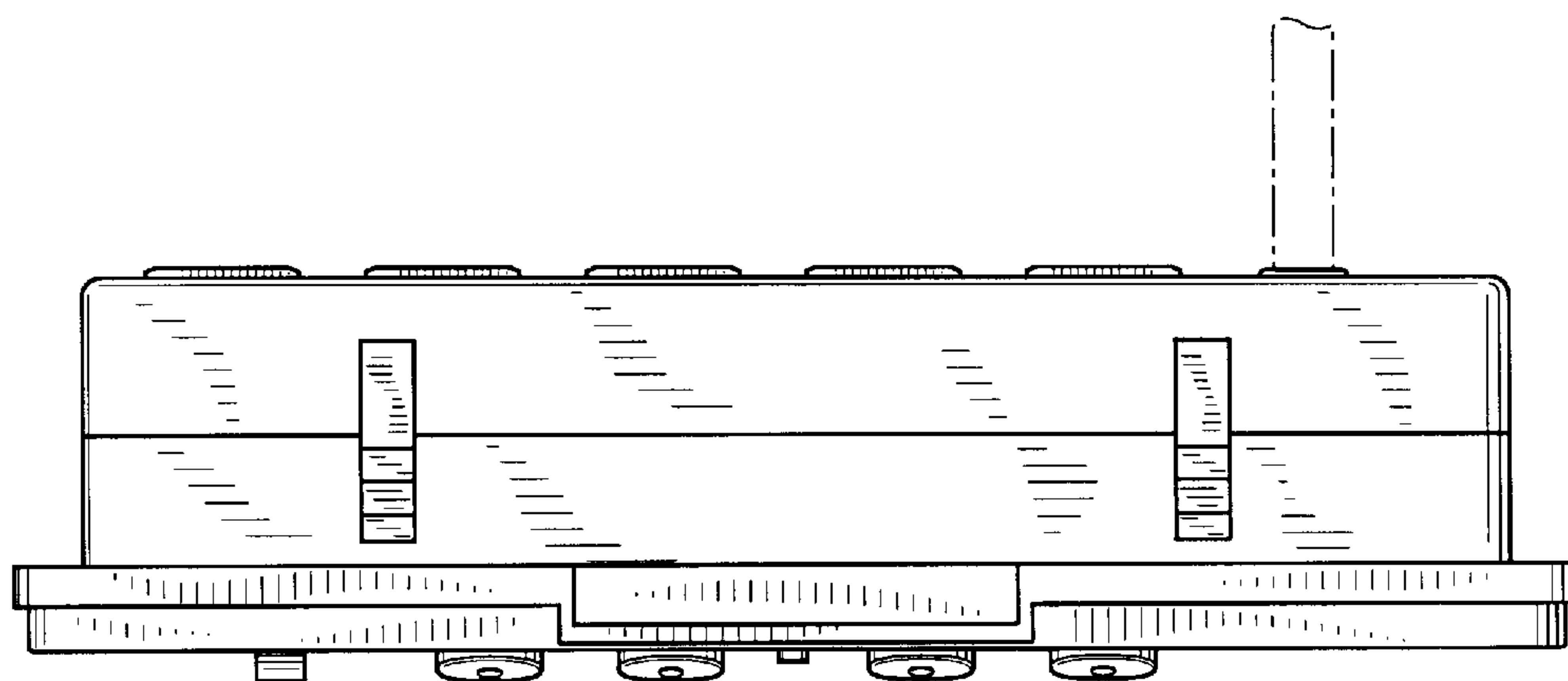

FIG. 8

