



US00D463223S

(12) **United States Design Patent**
Bien

(10) **Patent No.:** **US D463,223 S**

(45) **Date of Patent:** **** Sep. 24, 2002**

(54) **PIZZA SERVER**

D396,613 S * 8/1998 Cousins D7/688

(76) Inventor: **Rebecca M. Bien**, 1893 Viking Cir.,
Commerce Township, MI (US)
49390-1577

* cited by examiner

Primary Examiner—Terry A. Wallace
(74) *Attorney, Agent, or Firm*—Ronald R. Kilponen

(**) Term: **14 Years**

(57) **CLAIM**

(21) Appl. No.: **29/145,803**

I claim the ornamental design for the pizza server, as shown and described.

(22) Filed: **Jul. 30, 2001**

(51) **LOC (7) Cl.** **07-02**

DESCRIPTION

(52) **U.S. Cl.** **D7/696; D7/688**

FIG. 1 is a perspective view of the pizza server showing the new design;

(58) **Field of Search** D7/688-697; 294/7,
294/8; 15/236.01, 236.05, 236.08

FIG. 2 is a front view thereof;

FIG. 3 is a back view thereof;

FIG. 4 is a side view thereof;

FIG. 5 is a top view thereof;

FIG. 6 is a bottom view thereof; and,

FIG. 7 is a detail of the front edge thereof.

(56) **References Cited**

U.S. PATENT DOCUMENTS

D192,018 S * 1/1962 McLeod D7/688
4,569,130 A * 2/1986 Koller et al. 294/7 X
D292,663 S * 11/1987 Johnson D7/691
4,877,609 A * 10/1989 Beck et al. 294/7 X

1 Claim, 4 Drawing Sheets

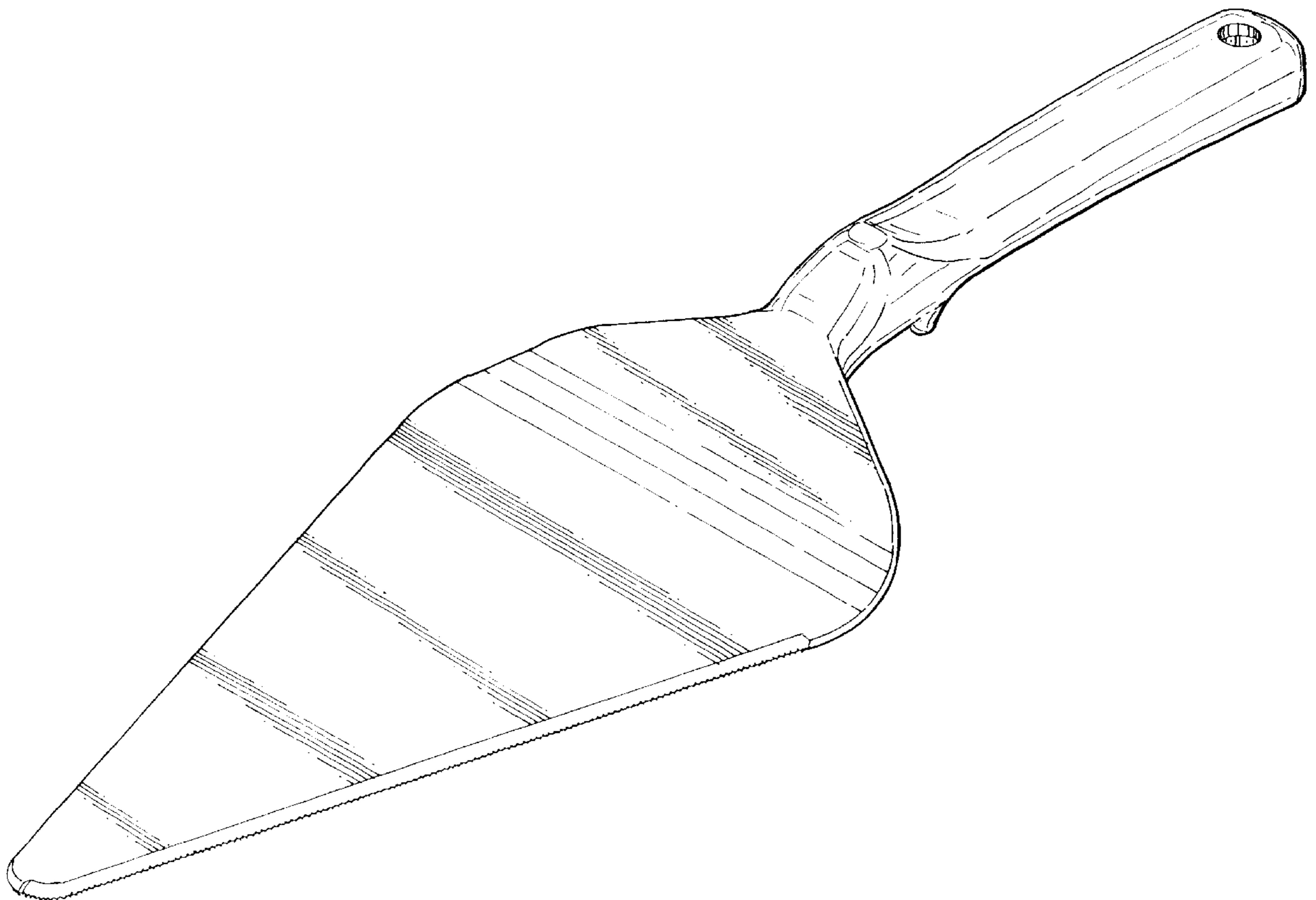

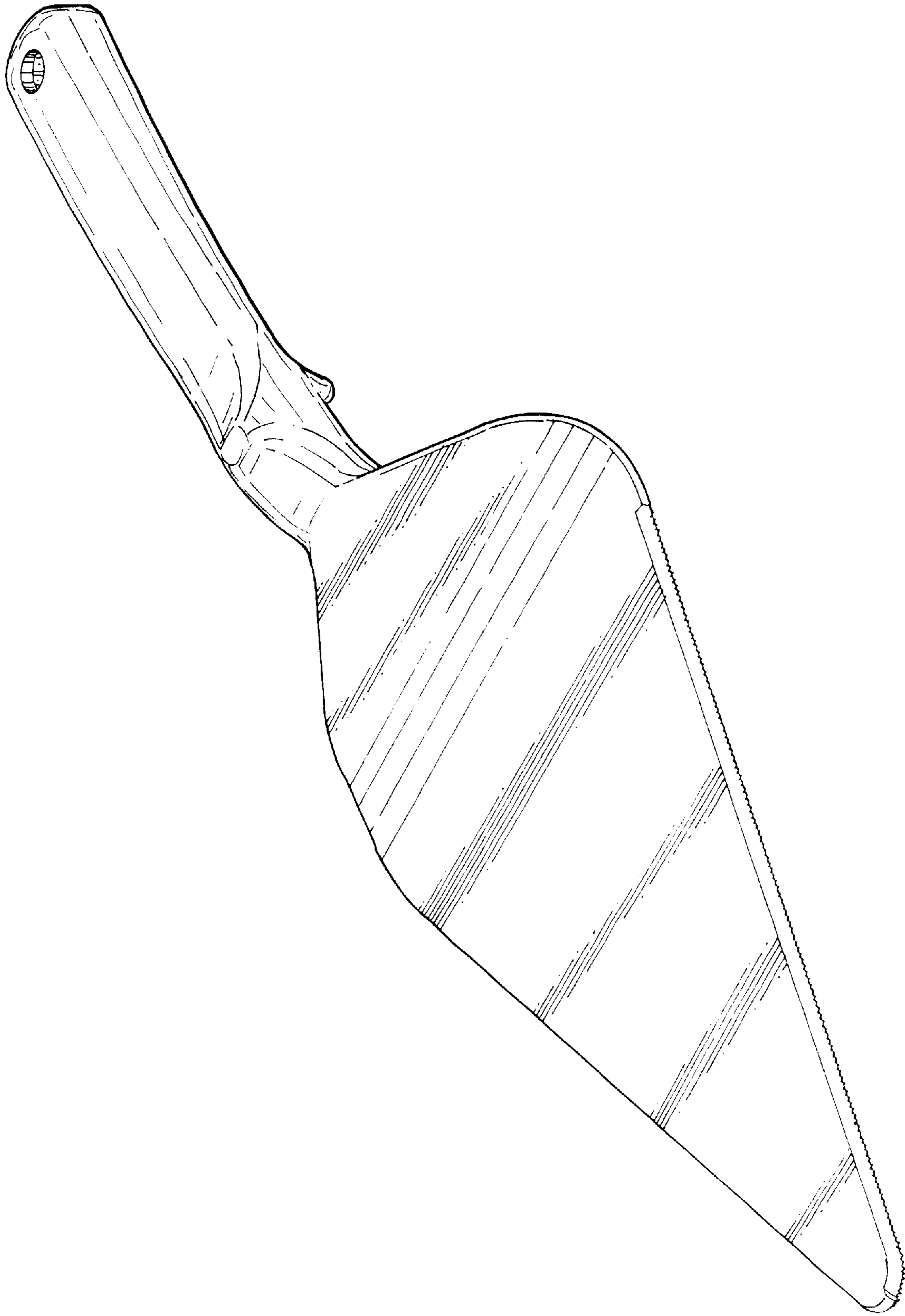

Fig. 1

Fig. 2

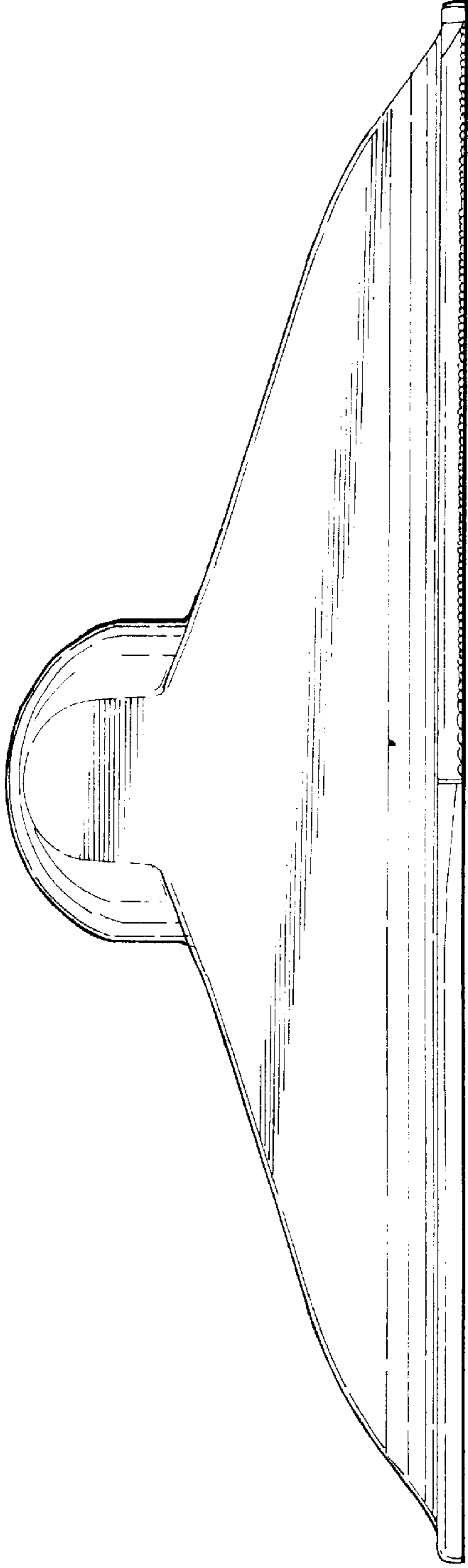

Fig. 3

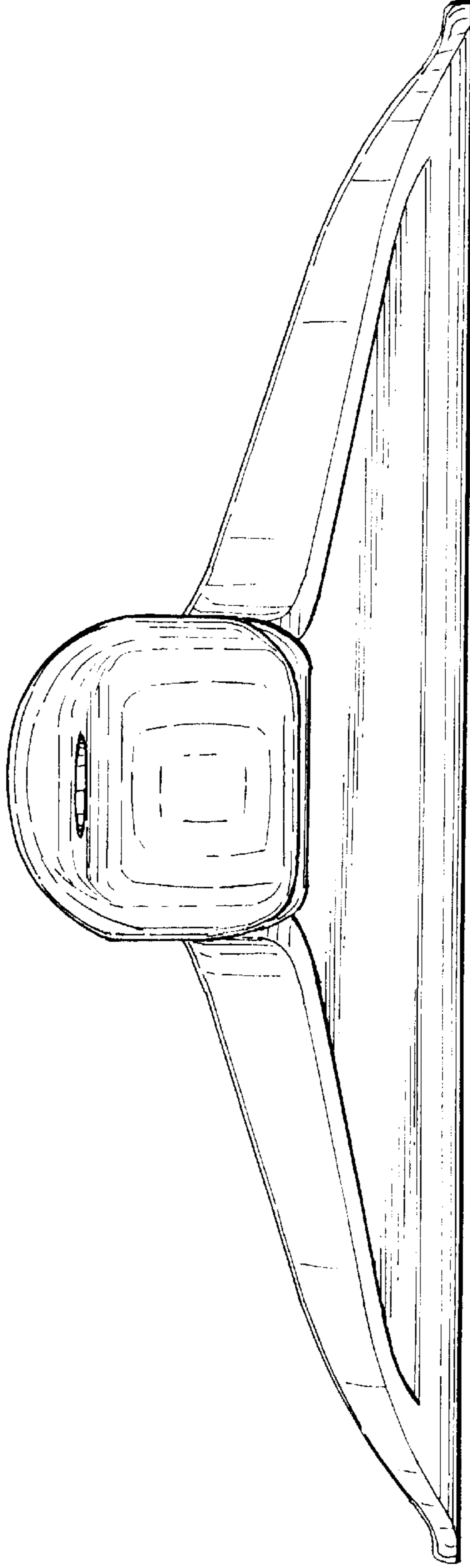
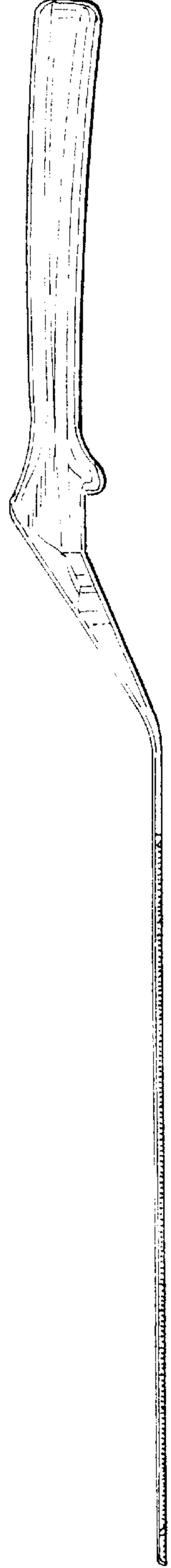

Fig. 4



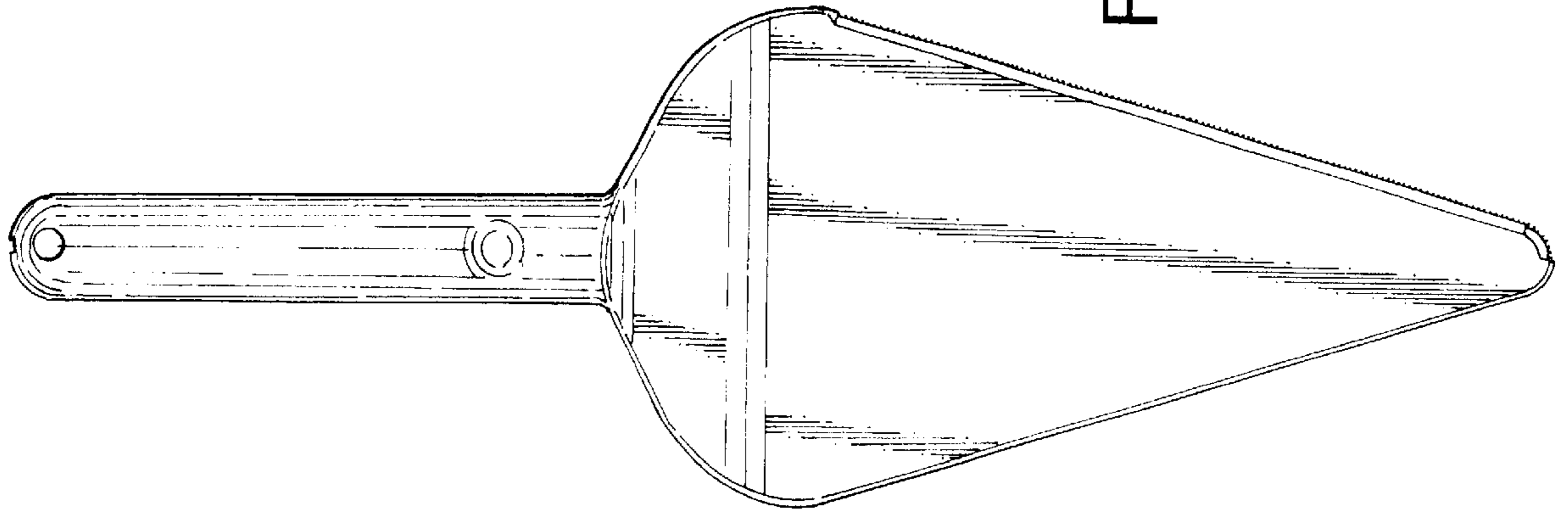

Fig. 6

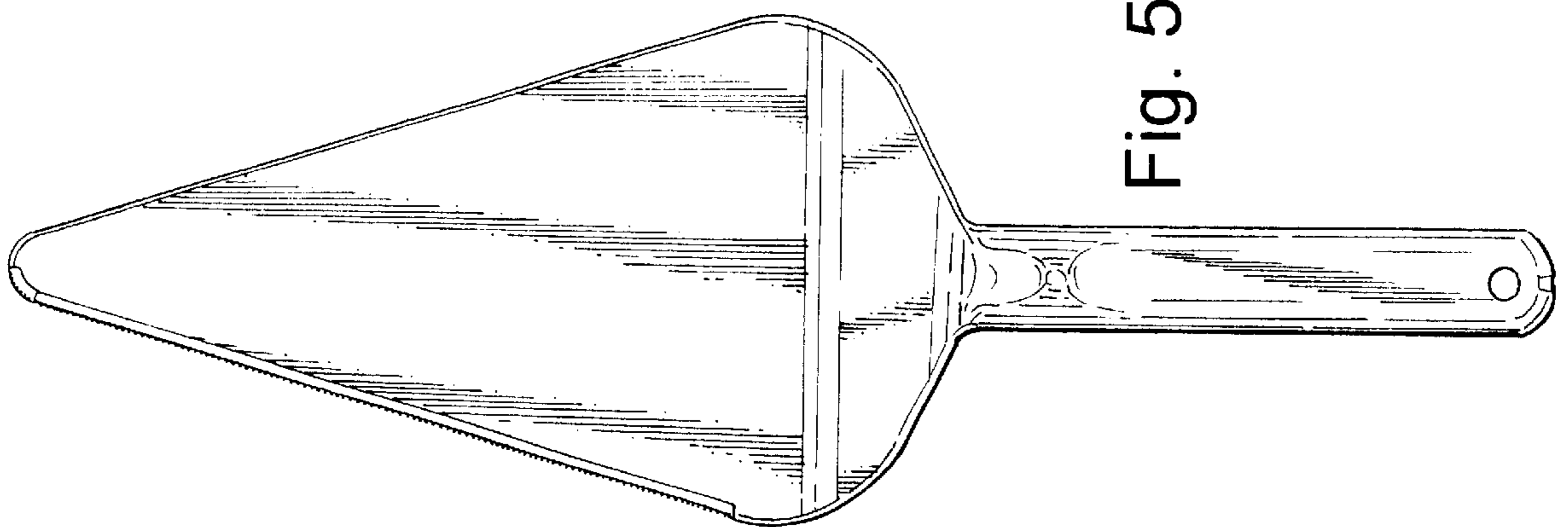

Fig. 5

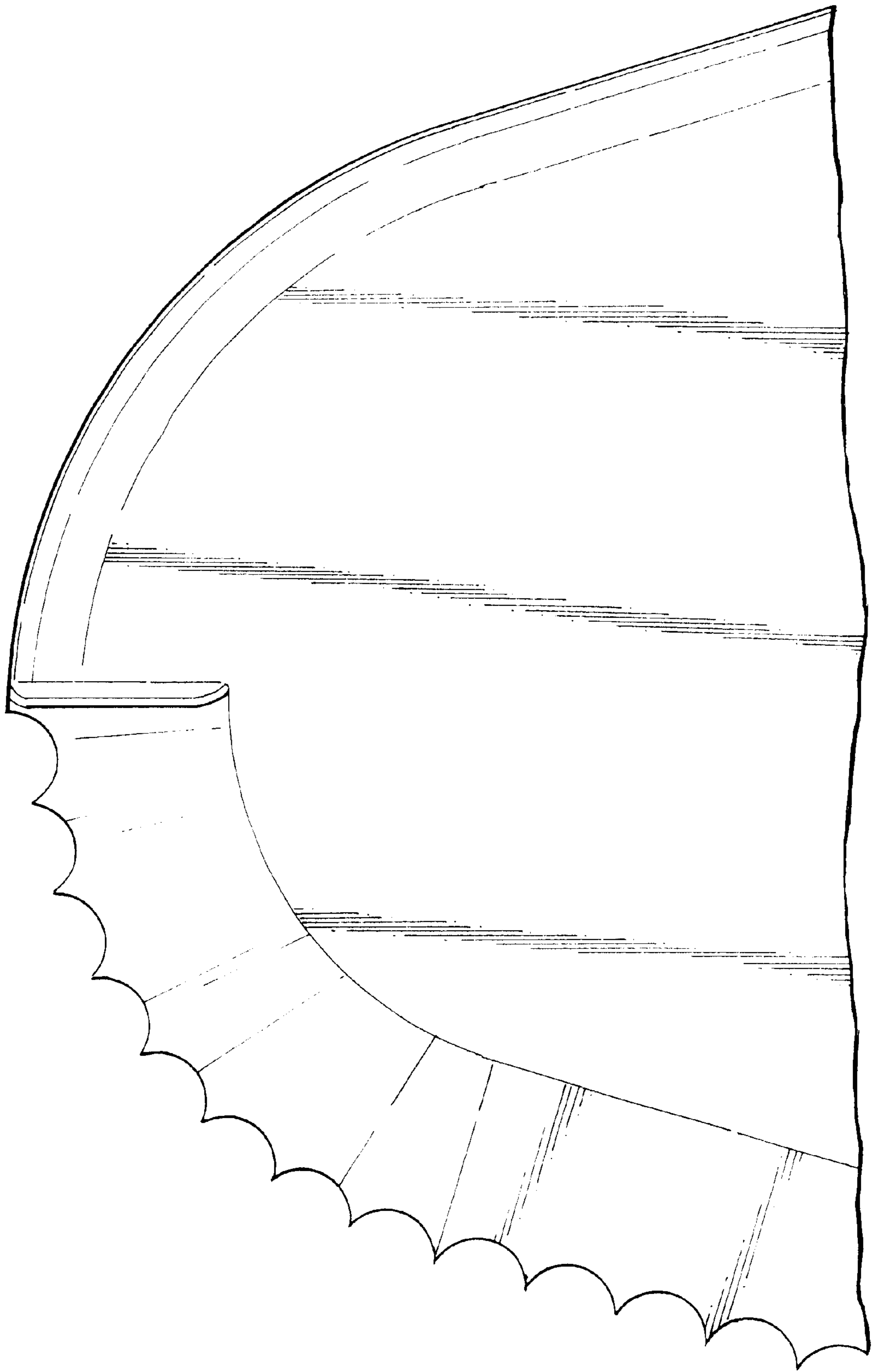

Fig. 7