



US00D463194S

(12) **United States Design Patent** (10) **Patent No.:** **US D463,194 S**
Busick et al. (45) **Date of Patent:** **** Sep. 24, 2002**

(54) **BEVERAGE COOLER**

(75) Inventors: **Louis M. Busick**, Columbus, OH (US);
Stephen W. Wharton, Columbus, OH (US);
Stephen J. Sabin, Ballina (IE);
Declan L. Coyle, Ballina (IE)

(73) Assignee: **Oasis Corporation**, Columbus, OH (US)

(**) Term: **14 Years**

(21) Appl. No.: **29/148,779**

(22) Filed: **Sep. 26, 2001**

(51) **LOC (7) Cl.** **07-01**

(52) **U.S. Cl.** **D7/313; D7/306**

(58) **Field of Search** D7/300, 306, 312,
D7/313, 307, 308; 137/371; 222/183, 185.1,
146.6, 146.1; 194/317; 210/466, 232; 62/3.64,
389, 3.63

(56) **References Cited**

U.S. PATENT DOCUMENTS

D161,592 S	*	1/1951	Persak, Jr.	D7/313
D164,941 S	*	10/1951	Nevell	D7/313
D199,408 S	*	10/1964	Felske	D7/313
3,289,895 A	*	12/1966	Yuza	222/146.1
4,145,291 A	*	3/1979	Console et al.	210/466
4,993,229 A	*	2/1991	Baus et al.	62/3.64
D358,289 S	*	5/1995	Thies et al.	D7/306
5,501,077 A		3/1996	Davis et al.		

5,513,495 A		5/1996	West et al.	
5,560,211 A		10/1996	Parker	
6,003,318 A		12/1999	Busick et al.	
D419,362 S	*	1/2000	Bouhuys D7/306
D431,145 S	*	9/2000	Woebcke et al. D7/306
D435,994 S	*	1/2001	Gaffney D7/306
D442,009 S	*	5/2001	Schwarzli D7/306
D443,792 S	*	6/2001	Peters et al. D7/306

* cited by examiner

Primary Examiner—M. N. Pandozzi

(74) *Attorney, Agent, or Firm*—Kelly Bauersfeld Lowry & Kelley, LLP

(57) **CLAIM**

The ornamental design for a beverage cooler, substantially as shown.

DESCRIPTION

FIG. 1 is a perspective view showing the front, top and right sides of a beverage cooler embodying our new design; FIG. 2 is a front elevation view thereof; FIG. 3 is a right side elevation view thereof, the left side elevation being a mirror image of the right side elevation as shown; FIG. 4 is a rear elevation view thereof; FIG. 5 is a top plan view thereof; FIG. 6 is a bottom plan view thereof; and, FIG. 7 is a perspective view showing the rear, top and left sides thereof.

1 Claim, 6 Drawing Sheets

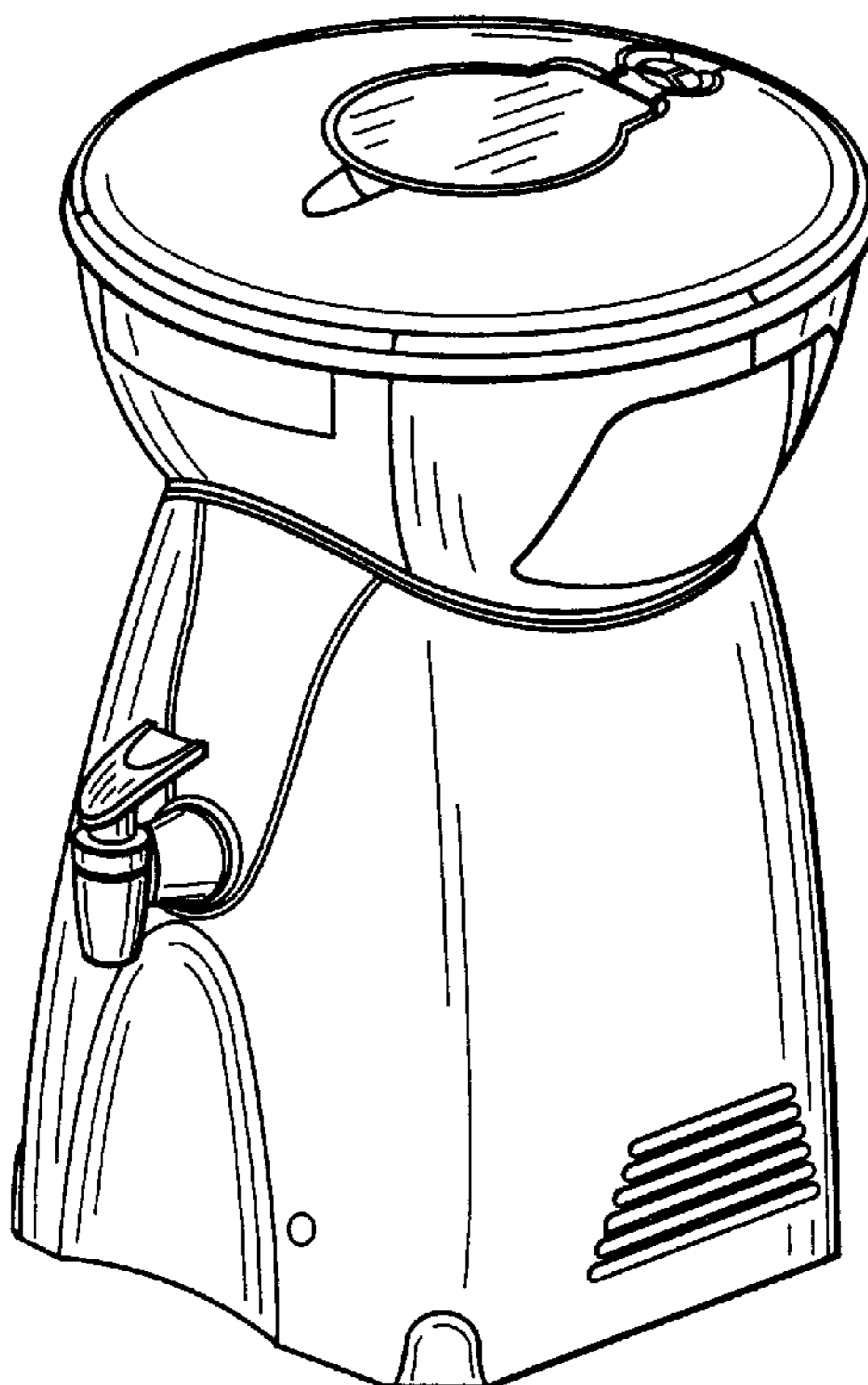

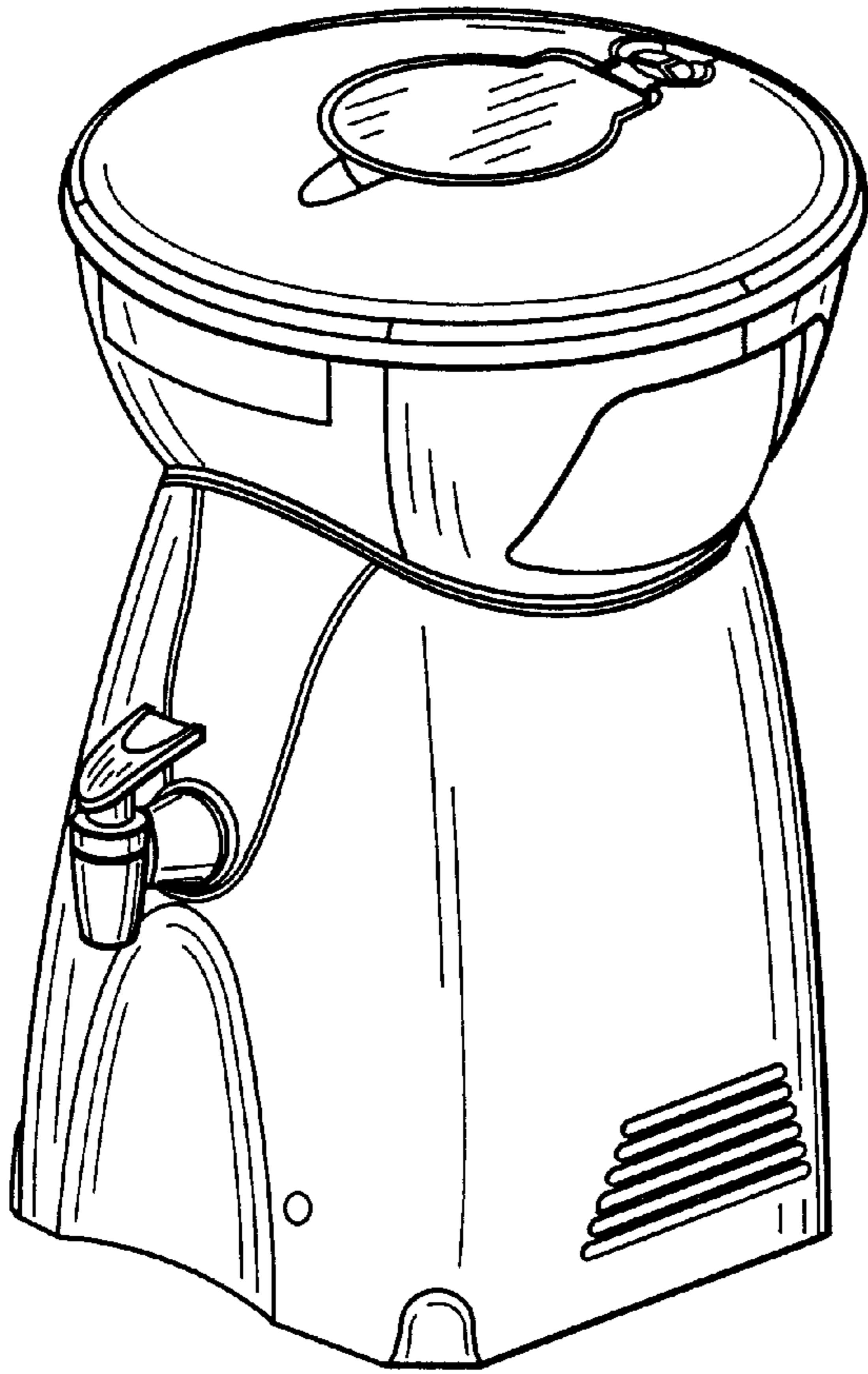

FIG. 1

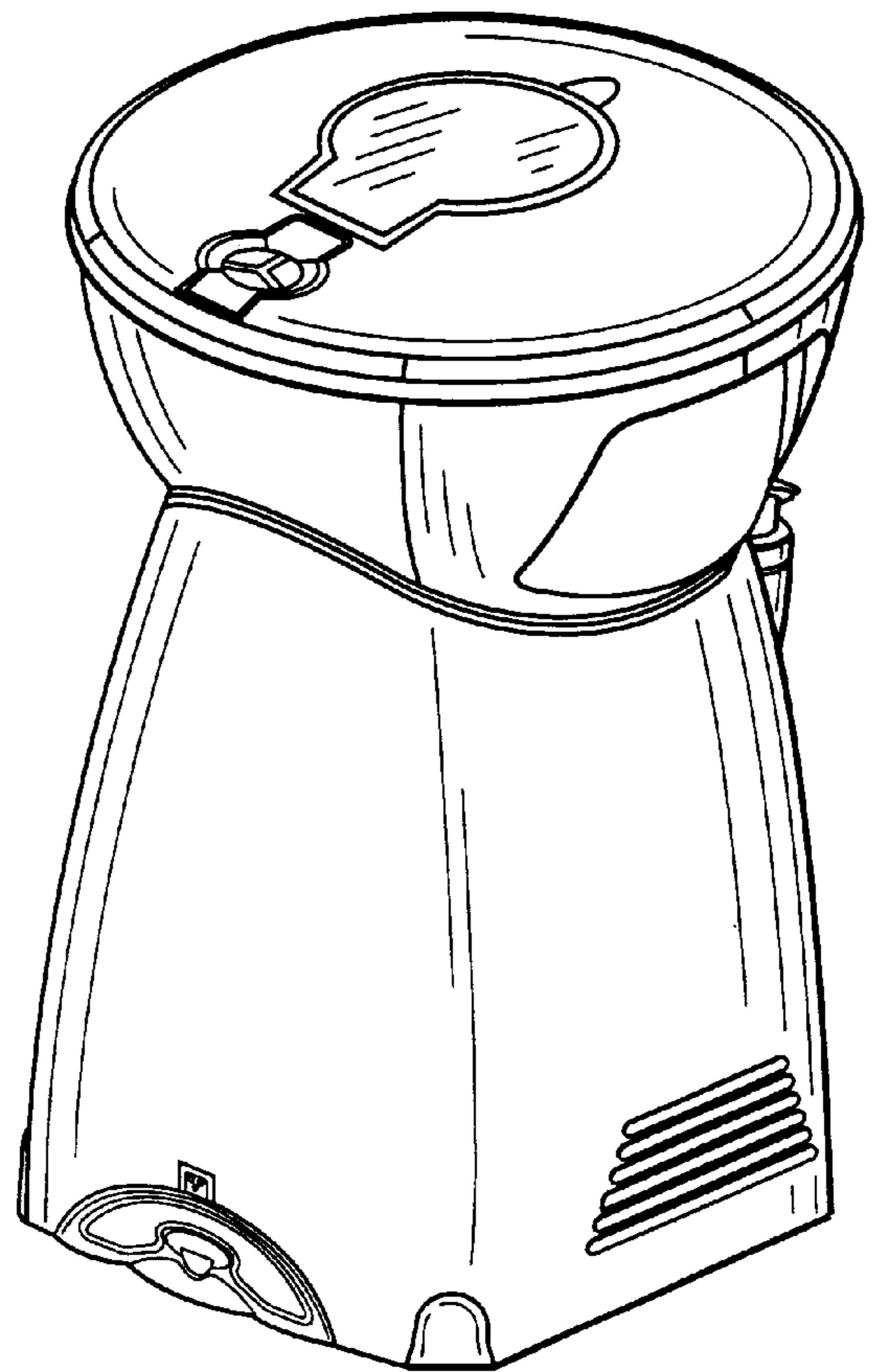

FIG. 7

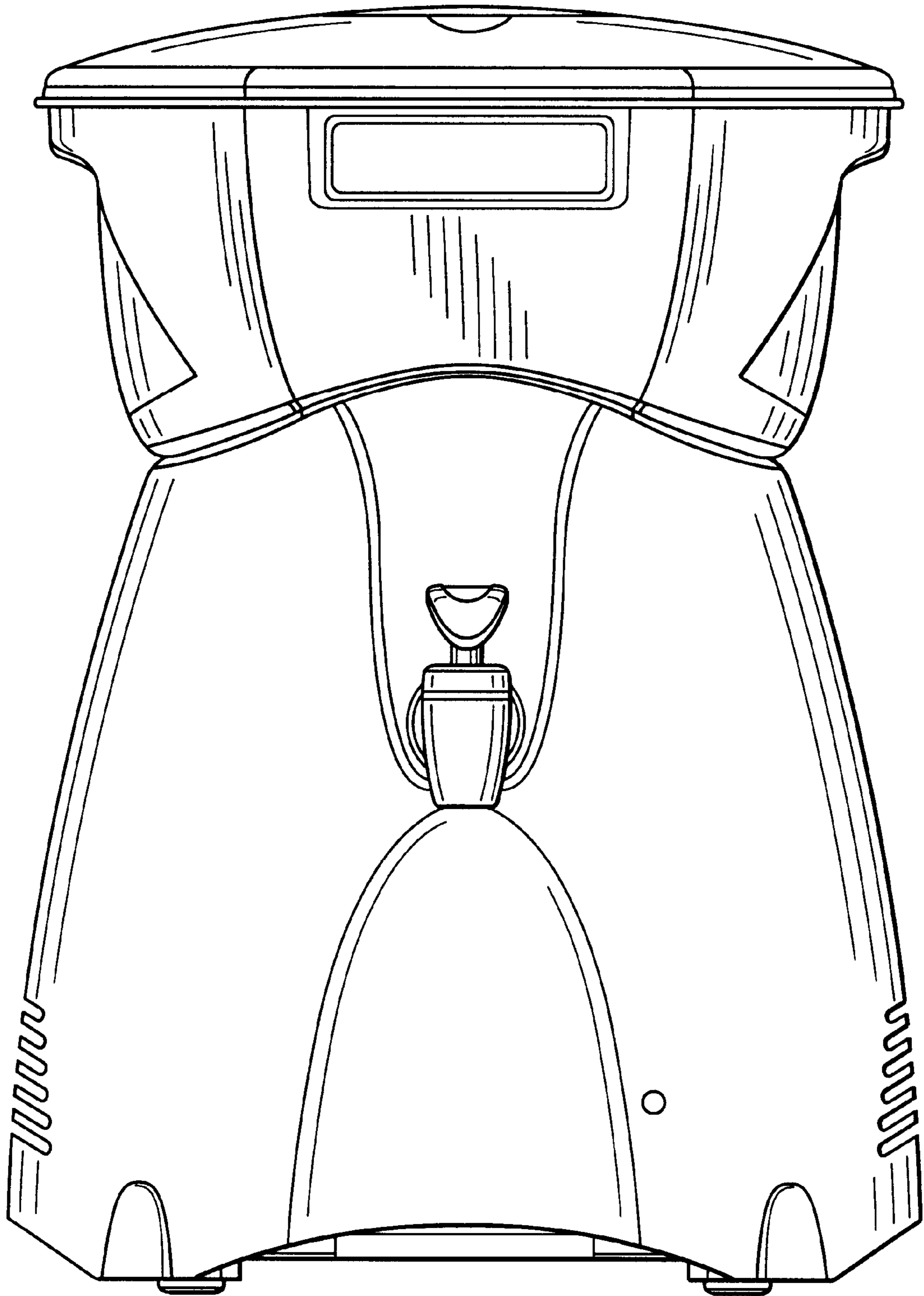

FIG. 2

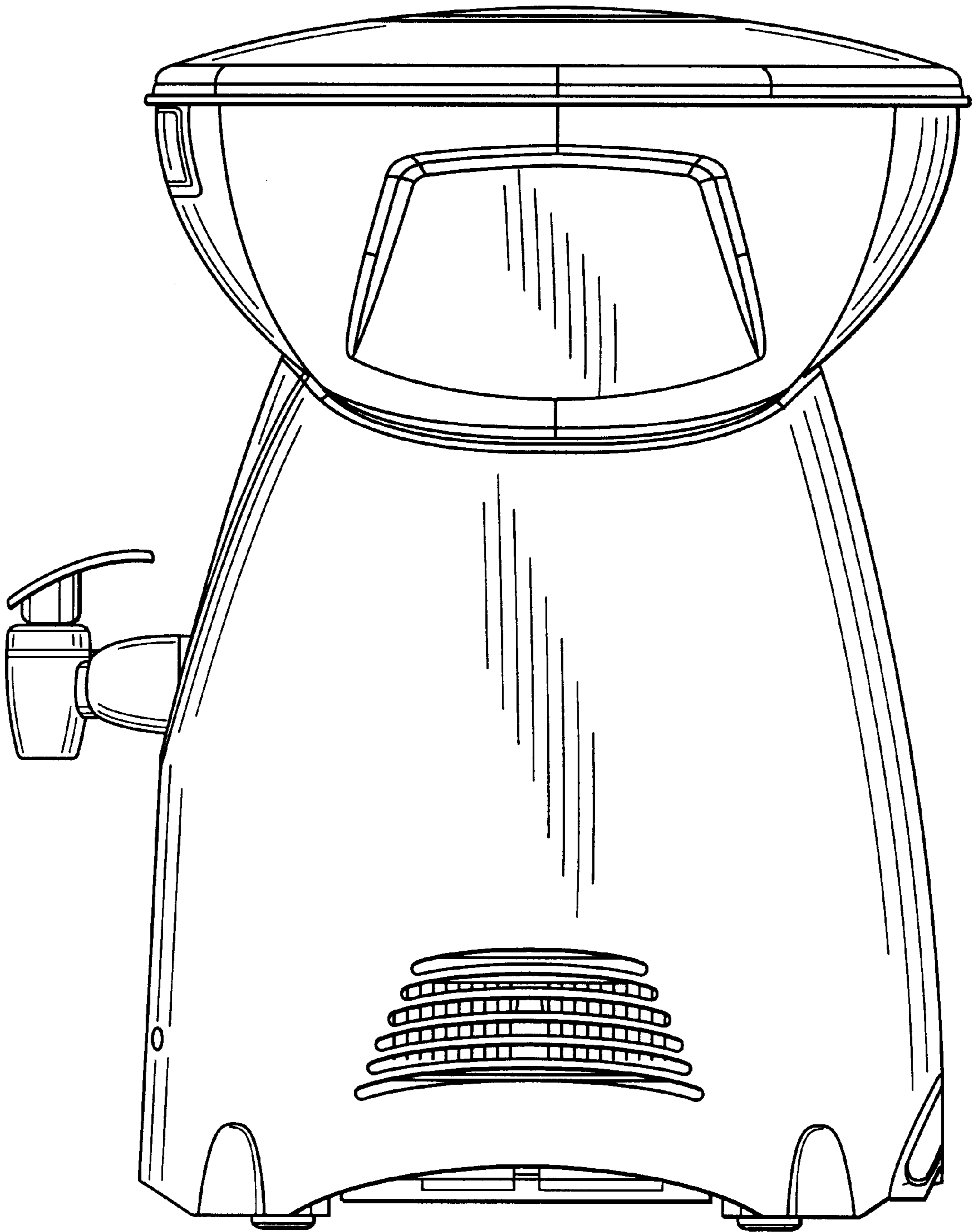

FIG. 3

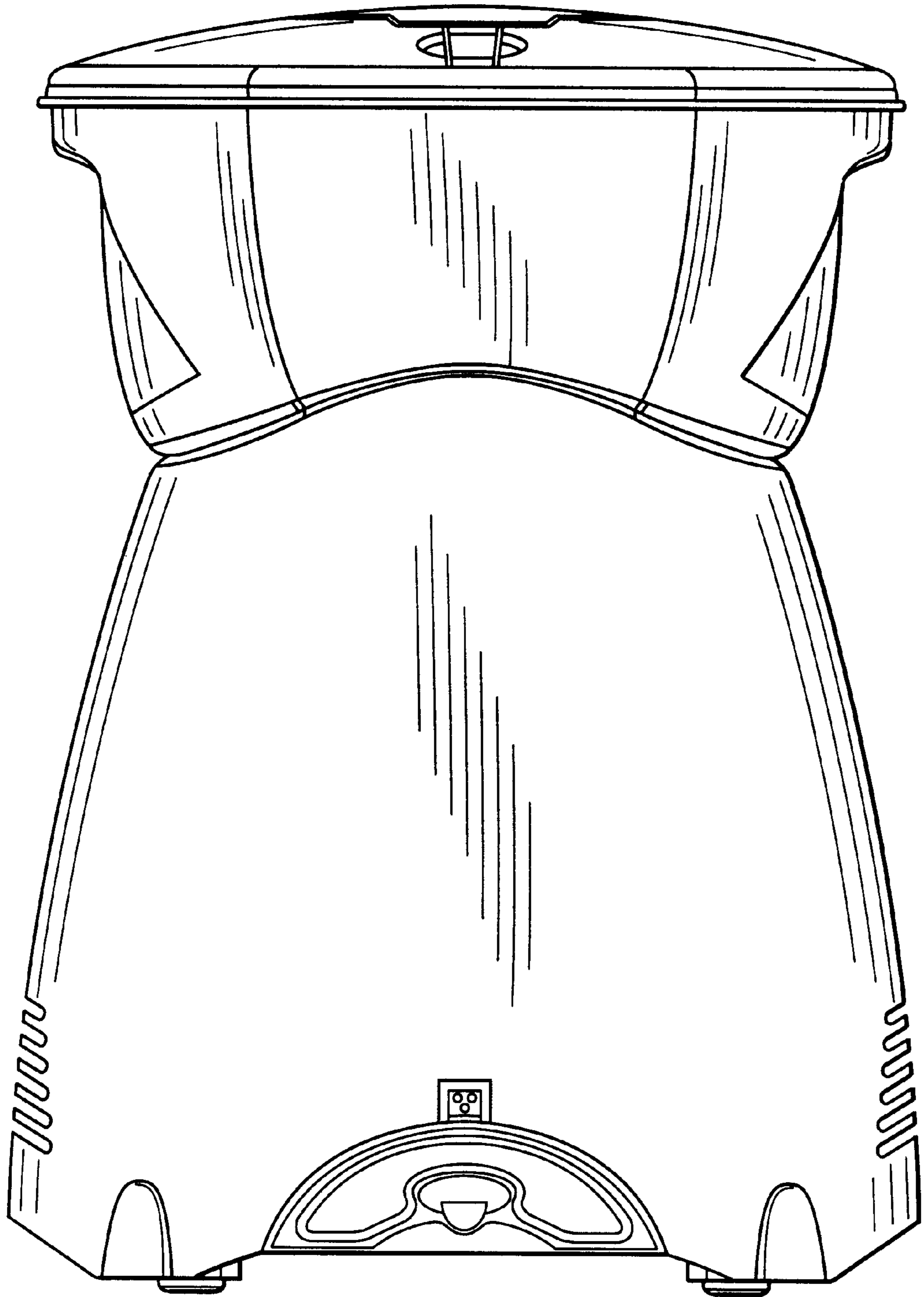

FIG. 4

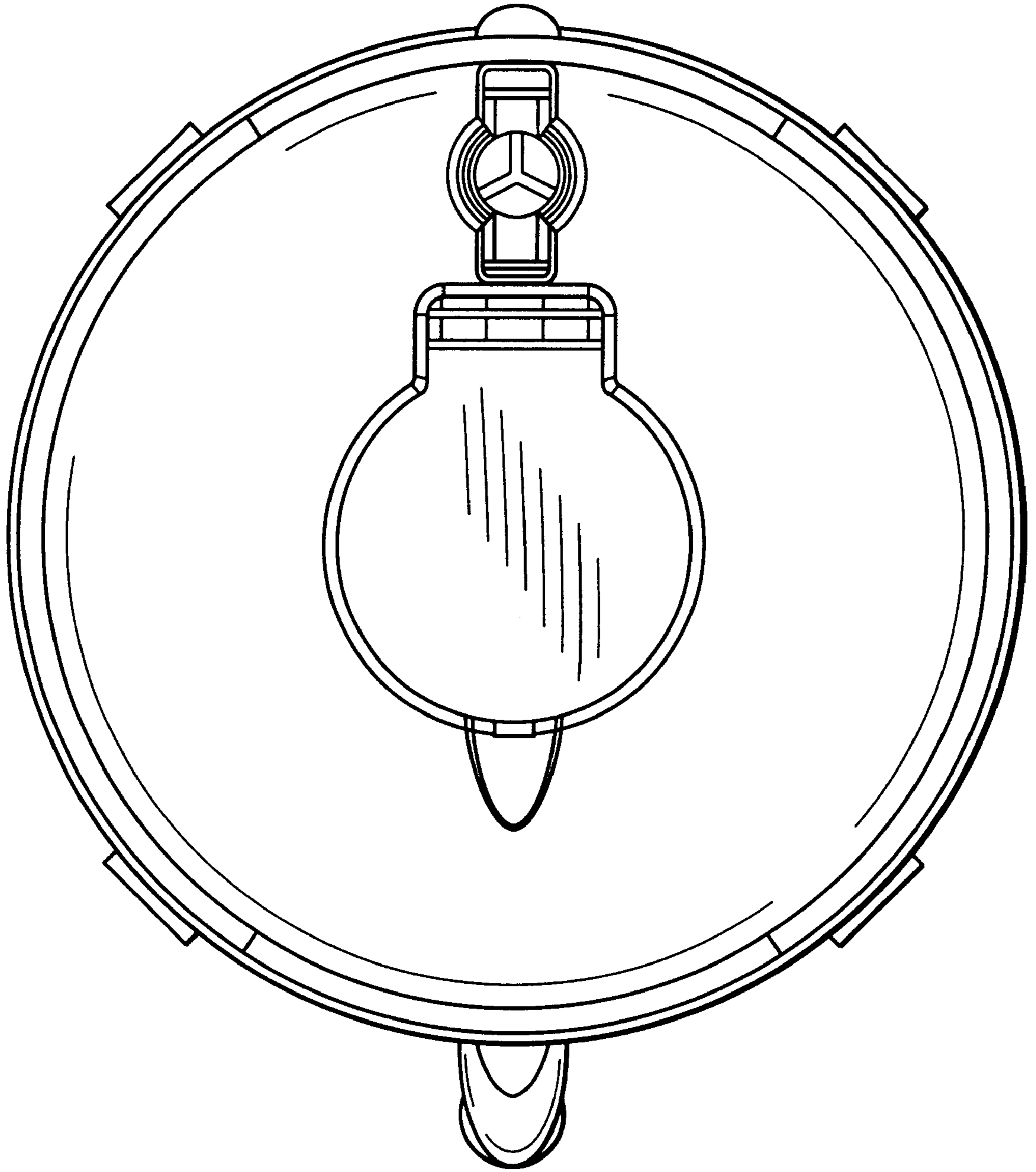

FIG. 5

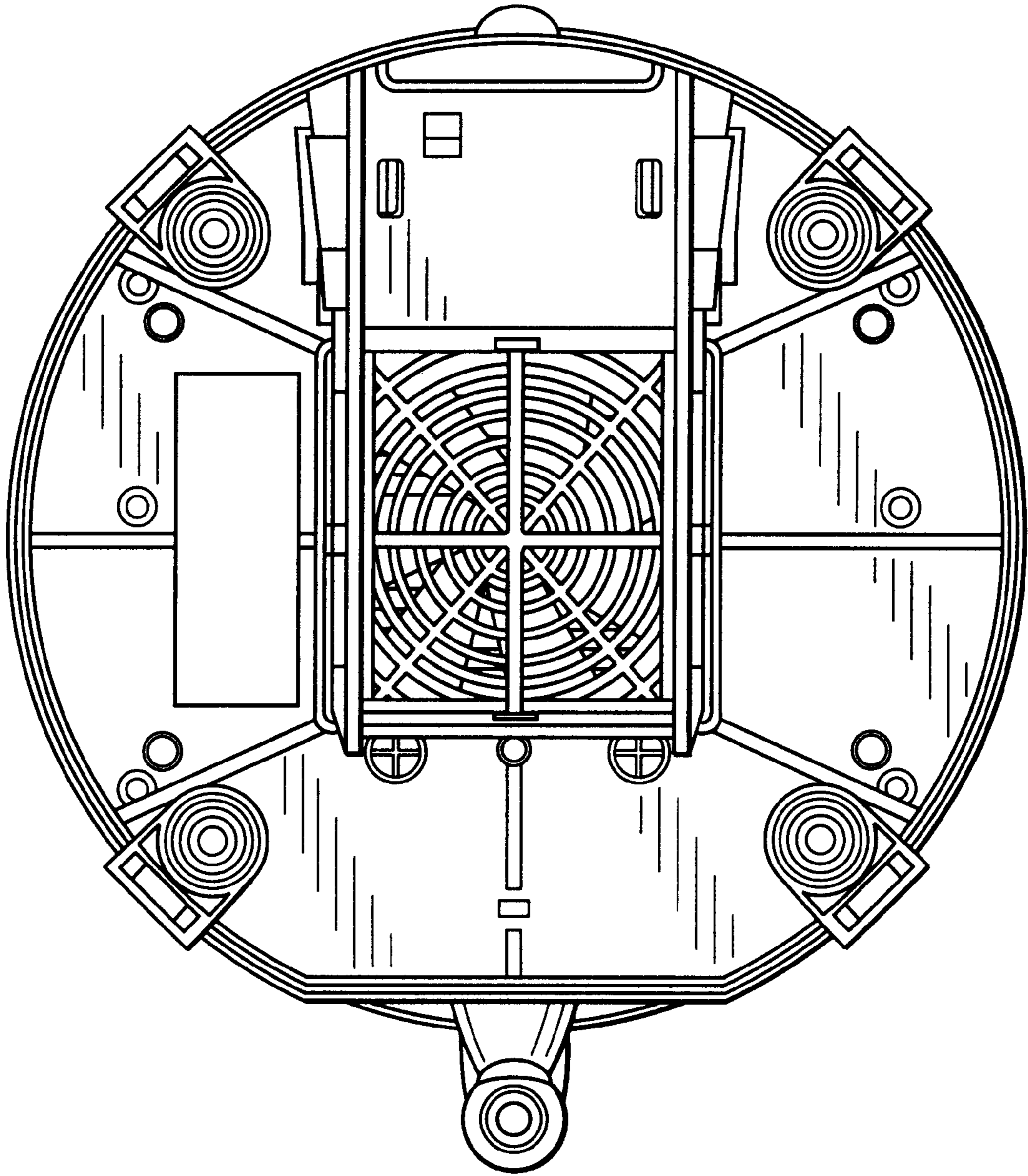

FIG. 6