



US00D463187S

(12) **United States Design Patent**
Gilbert

(10) **Patent No.:** **US D463,187 S**

(45) **Date of Patent:** **** Sep. 24, 2002**

(54) **TOWEL BAR**

(75) **Inventor:** **Christopher Jon Gilbert**, Moreland Hills, OH (US)

(73) **Assignee:** **Moen Incorporated**, North Olmsted, OH (US)

(**) **Term:** **14 Years**

(21) **Appl. No.:** **29/140,554**

(22) **Filed:** **Apr. 23, 2001**

(51) **LOC (7) Cl.** **06-04**

(52) **U.S. Cl.** **D6/549**

(58) **Field of Search** D6/546-50, 518, D6/522-24; D8/300, 315-21, 354, 363, 373, 380; 108/28-29; 211/13.1, 16, 60.1, 86.01, 87.01, 88.04, 100, 105.1-105.2, 123, 181.1, 182; 248/175, 176.1, 251, 302; 16/110.1, 412, 415; 242/570, 590, 595-598; 206/389

(56) **References Cited**

U.S. PATENT DOCUMENTS

D286,963 S	12/1986	Waghorn	
D299,095 S	12/1988	Gresens et al.	
D299,099 S	12/1988	Gresens et al.	
D357,379 S	* 4/1995	Lehn et al. D6/549
D357,840 S	5/1995	Lehn et al.	
D361,006 S	8/1995	Sharpe	
D389,326 S	1/1998	Moore	
D392,139 S	* 3/1998	Wu D6/549

D394,574 S	5/1998	Moore	
D394,973 S	6/1998	Moore et al.	
D408,188 S	4/1999	Kuo	
D410,377 S	6/1999	Bredemeir	
D417,995 S	* 12/1999	Chen D6/550
D424,352 S	* 5/2000	Roth et al. D6/549
D424,354 S	5/2000	Duggan	
D426,095 S	6/2000	Chen	
D431,742 S	10/2000	Chen	
D431,948 S	10/2000	Chen	
D432,840 S	10/2000	Solowiej	
D434,934 S	12/2000	Solowiej	
D436,275 S	1/2001	Lai	

* cited by examiner

Primary Examiner—Brian N. Vinson
(74) *Attorney, Agent, or Firm*—Cook, Alex, McFarron, Manzo, Cummings & Mehler, Ltd.

(57) **CLAIM**

The ornamental design for a towel bar, as shown and described.

DESCRIPTION

FIG. 1 is a top front perspective view of my new design for a towel bar;
FIG. 2 is a left side view thereof, the right side being the same as the left side;
FIG. 3 is a front view thereof;
FIG. 4 is a bottom view thereof;
FIG. 5 is a rear view thereof; and,
FIG. 6 is a top view thereof.

1 Claim, 2 Drawing Sheets

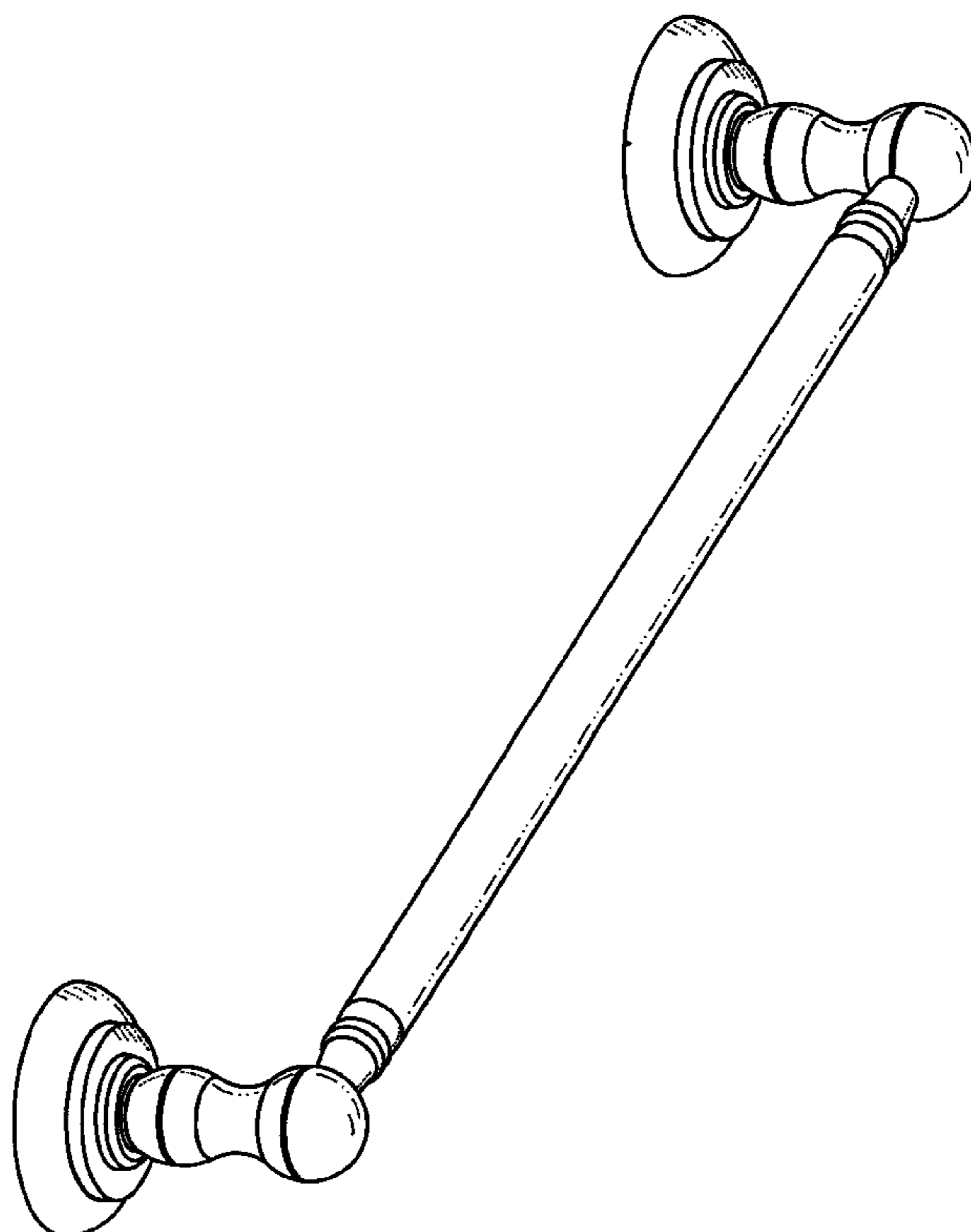

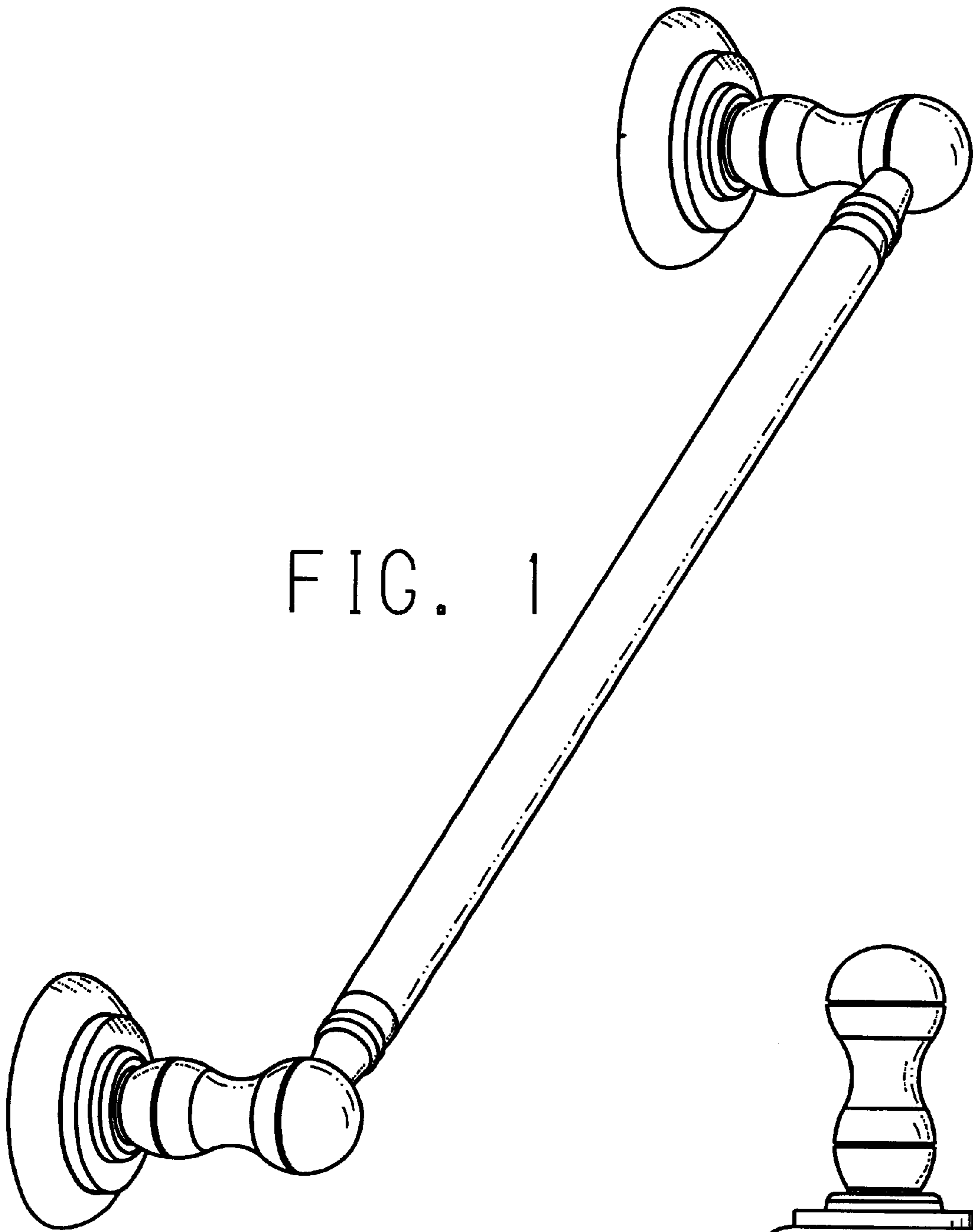

FIG. 1

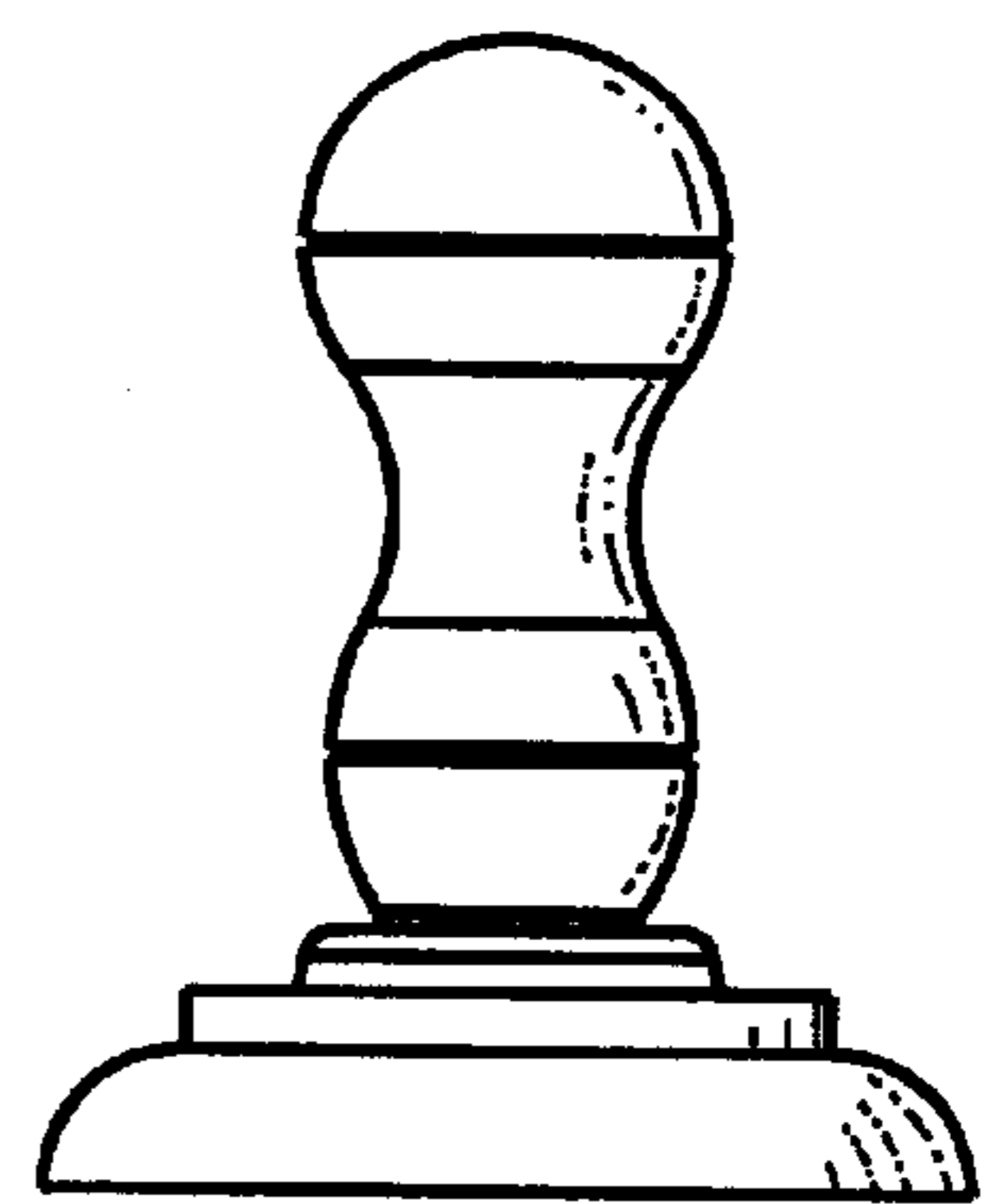

FIG. 2

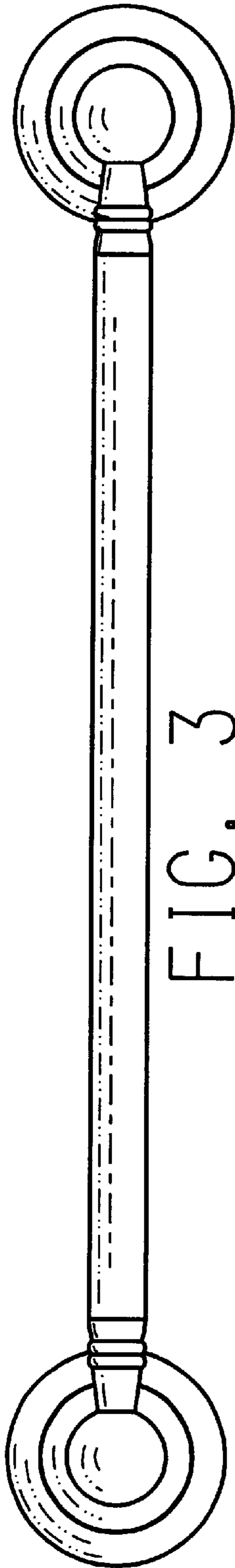

FIG. 3

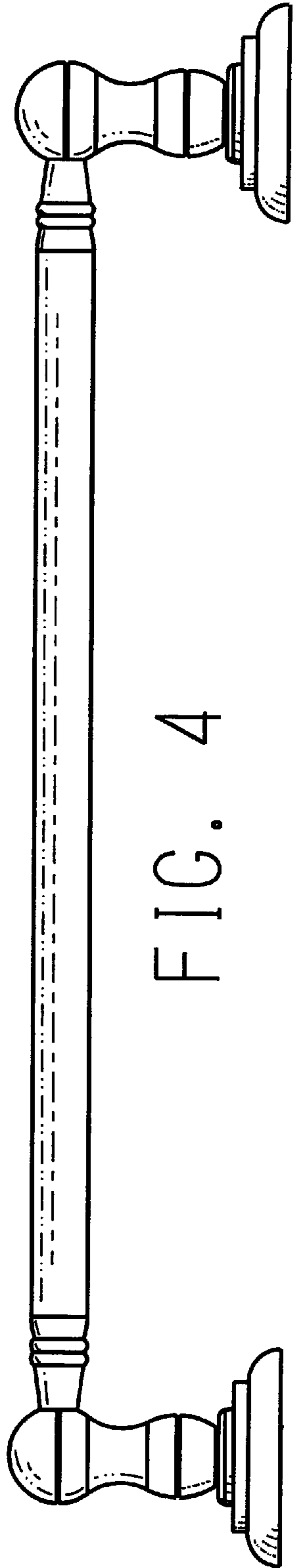

FIG. 4

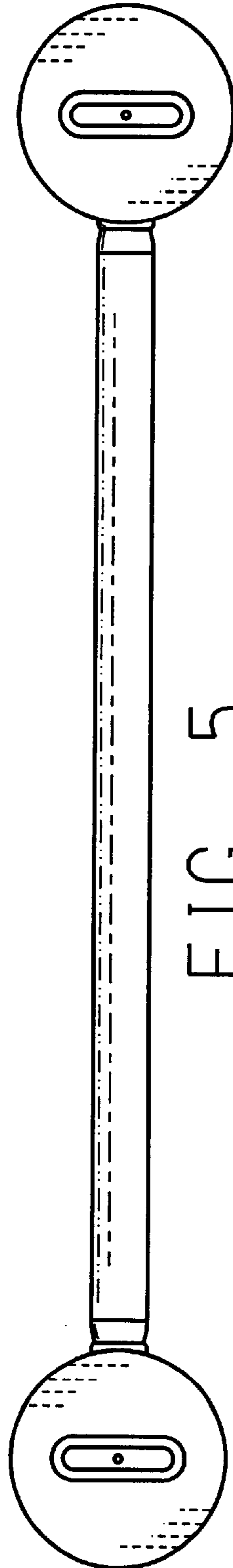

FIG. 5

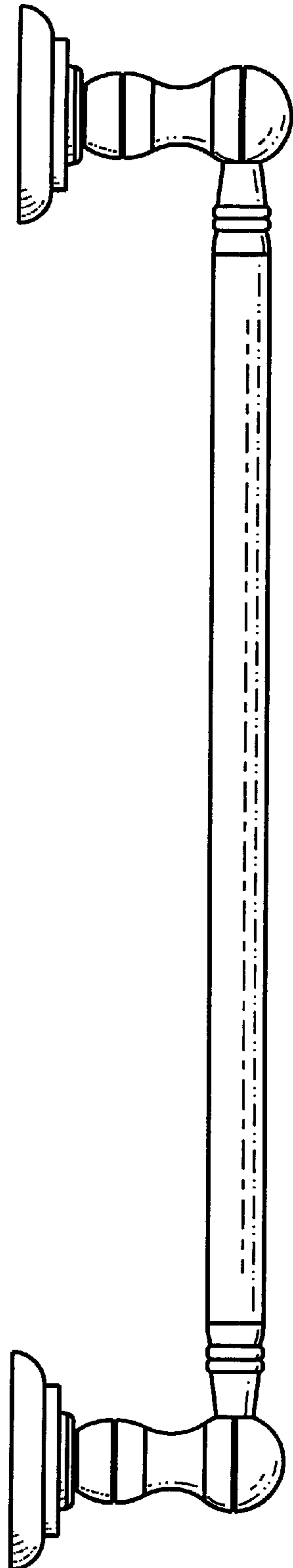

FIG. 6