



US00D463180S

(12) **United States Design Patent**
Sawan

(10) **Patent No.:** **US D463,180 S**

(45) **Date of Patent:** **** Sep. 24, 2002**

(54) **BED FRAME**

(76) Inventor: **Victor Sawan**, 12218 Montana Ave.,
#405, Los Angeles, CA (US) 90049

(**) Term: **14 Years**

(21) Appl. No.: **29/148,376**

(22) Filed: **Sep. 19, 2001**

(51) **LOC (7) Cl.** **06-06**

(52) **U.S. Cl.** **D6/503; D6/392; D6/393**

(58) **Field of Search** **D6/382, 389, 392-395,**
D6/505-508; 5/53.1, 279.1, 280, 281, 907,
200.1, 174

(56) **References Cited**

U.S. PATENT DOCUMENTS

D181,173 S	*	10/1957	Wetzler	D6/382
2,841,209 A	*	7/1958	Wetzler	5/200.1
5,996,145 A	*	12/1999	Taylor	5/200.1
D433,246 S	*	11/2000	Pettifer	D6/382

* cited by examiner

Primary Examiner—Janice E. Seeger

(74) *Attorney, Agent, or Firm*—Harvey S. Hertz

(57) **CLAIM**

The ornamental design for a bed frame, as shown and described.

DESCRIPTION

FIG. 1 is a perspective view of a front, top and left side of a bed frame showing my new design, the broken line disclosure of a headboard and return posts being for illustrative purposes only and forming no part of the claimed design, showing my new design;

FIG. 2 is a right side elevational view thereof, the left side being a mirror image;

FIG. 3 is a front elevational view thereof;

FIG. 4 is a rear elevational view thereof;

FIG. 5 is a top plan view thereof;

FIG. 6 is a bottom plan view thereof;

FIG. 7 is a perspective view of the front, top and left side view of an alternate embodiment, the broken line disclosure of a headboard and footboard being for illustrative purposes only and forming no part of the claimed design; and,

FIG. 8 is a front elevational view of the alternate embodiment, the rear elevational view being a mirror image thereof.

1 Claim, 5 Drawing Sheets

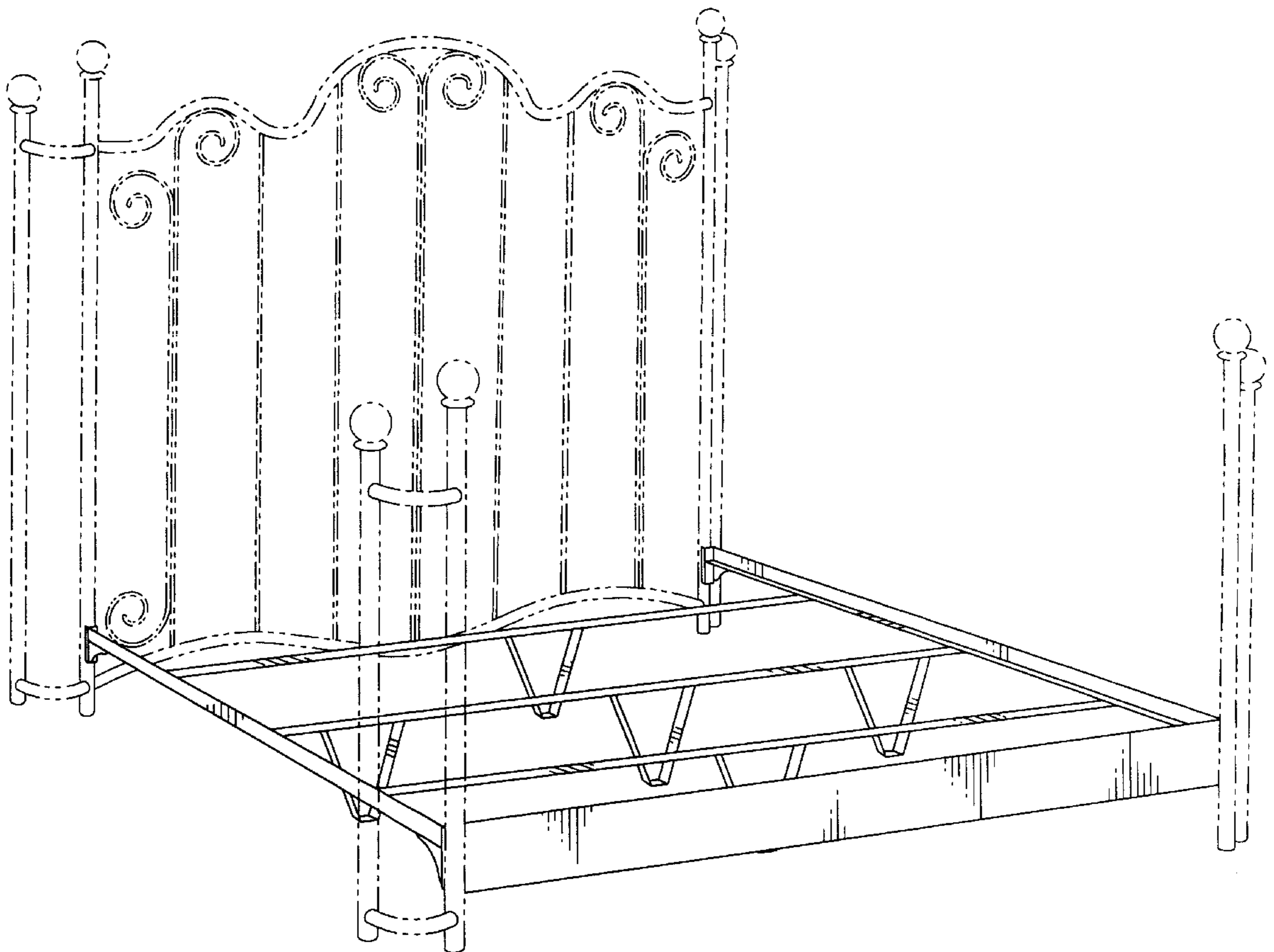

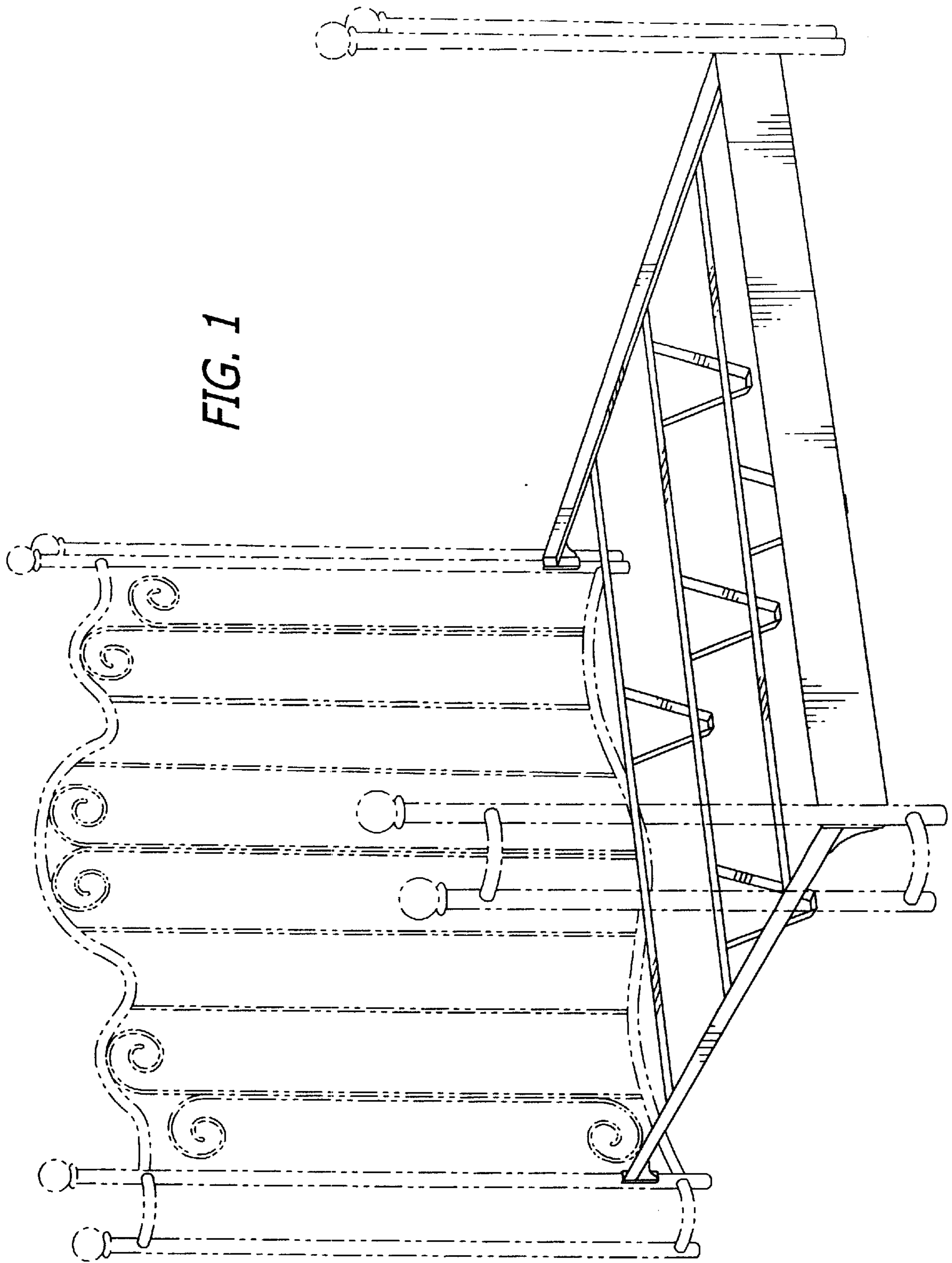

FIG. 1

FIG. 2

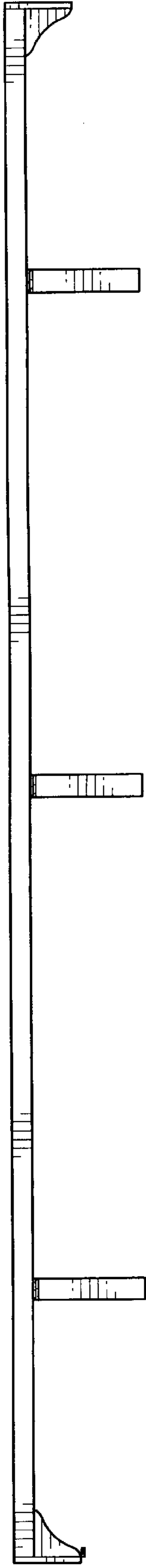

FIG. 3

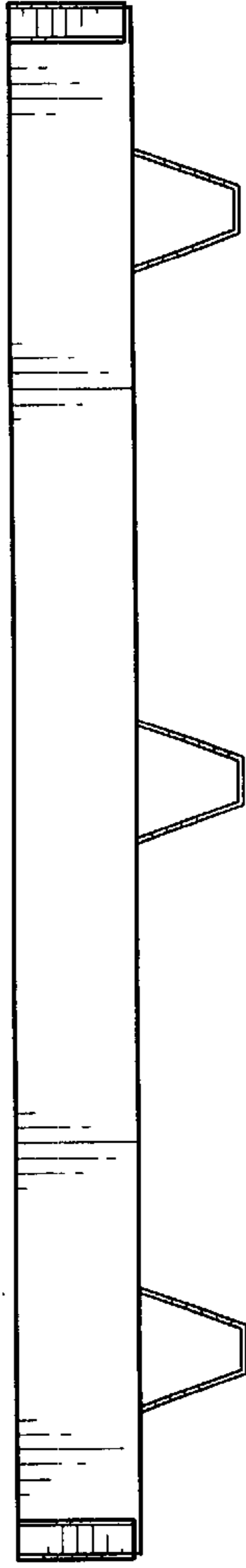

FIG. 4

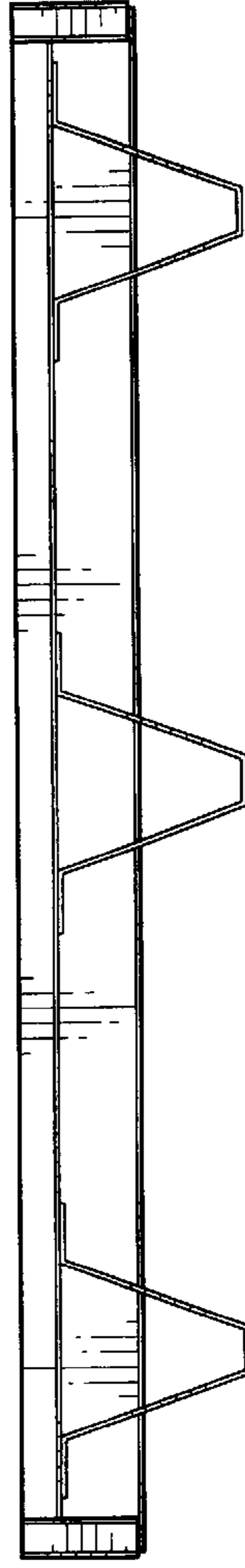

FIG. 8

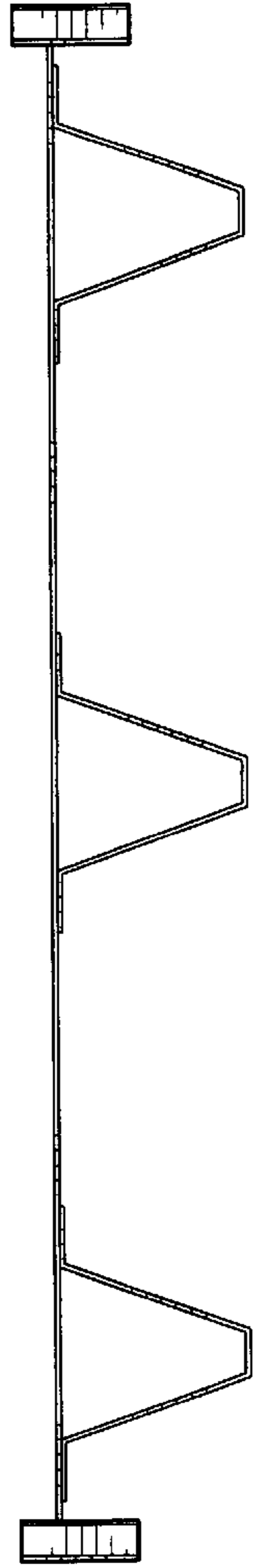

FIG. 5

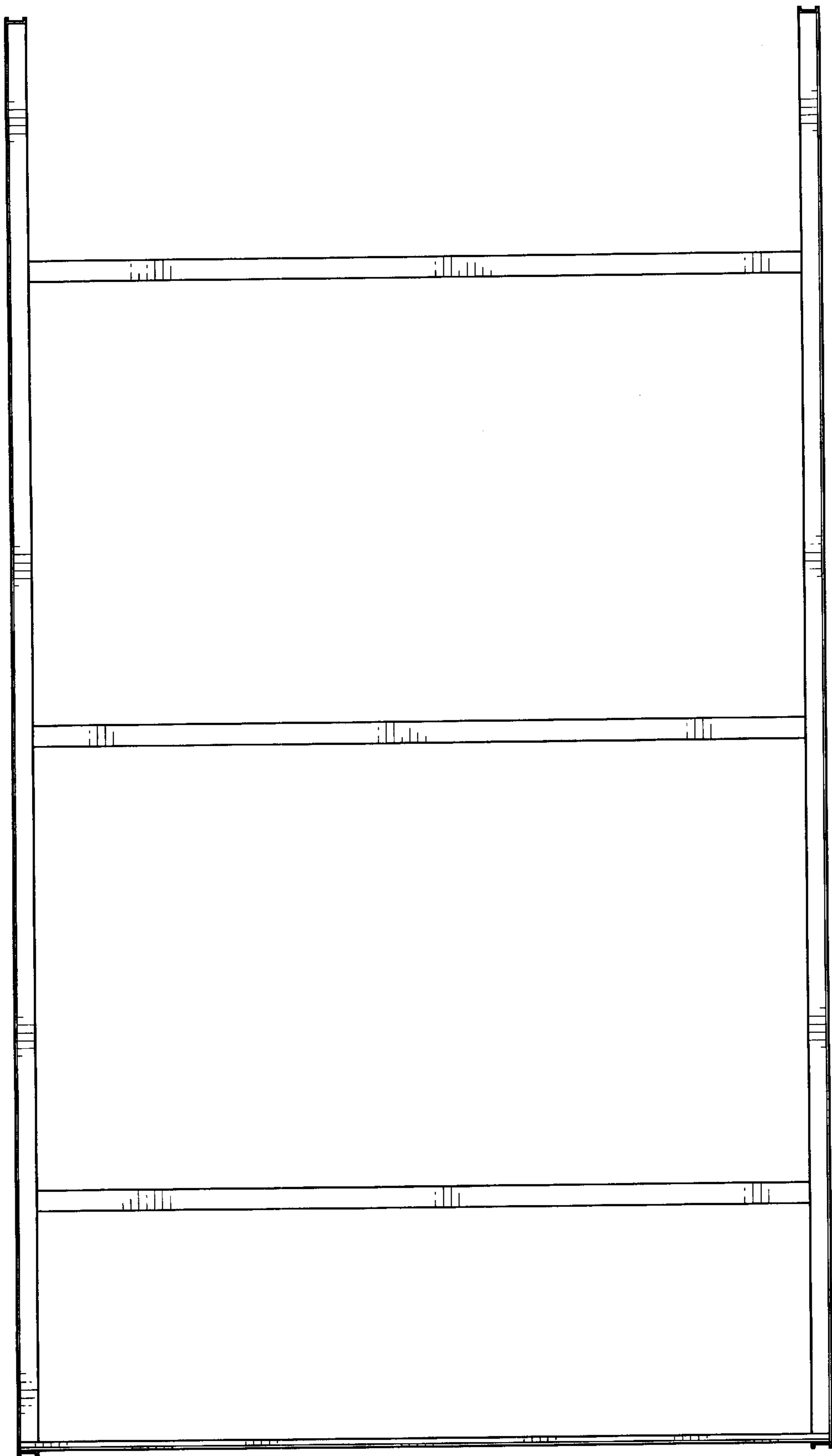

FIG. 6

