



US00D463056S

(12) **United States Design Patent**
Waites

(10) **Patent No.:** **US D463,056 S**

(45) **Date of Patent:** **** Sep. 17, 2002**

(54) **DENTAL LIGHT**

(75) Inventor: **George Waites**, Fletcher, NC (US)

(73) Assignee: **Midmark Corporation**, Versailles, OH (US)

(**) Term: **14 Years**

(21) Appl. No.: **29/149,582**

(22) Filed: **Oct. 12, 2001**

(51) **LOC (7) Cl.** **26-05**

(52) **U.S. Cl.** **D26/65**

(58) **Field of Search** D26/60-66; 362/275,
362/277, 282, 283, 285, 287, 413, 418,
419, 427

(56) **References Cited**

U.S. PATENT DOCUMENTS

D214,188 S	*	5/1969	Lauterbach	D26/60
D297,056 S	*	8/1988	Sesiak	D26/65
D437,957 S	*	2/2001	Borders et al.	D26/65

OTHER PUBLICATIONS

Midmark Corporation, *Classic Operatories*, Knight by Midmark, 2000 (10 pages).

Midmark Corporation, *Midmark Universal Mounted Light*, Midmark Corporation, 2001 (2 pages).

* cited by examiner

Primary Examiner—Marcus A. Jackson

(74) *Attorney, Agent, or Firm*—Wood, Herron & Evans, LLP

(57) **CLAIM**

The ornamental design for dental light, as shown and described.

DESCRIPTION

FIG. 1 is a front perspective view of a dental light incorporating the design of my new invention;

FIG. 2 is a rear perspective view thereof;

FIG. 3 is a front elevational view thereof;

FIG. 4 is a right side elevational view thereof;

FIG. 5 is a rear elevational view thereof;

FIG. 6 is a top plan view thereof; and,

FIG. 7 is a bottom plan view thereof.

The features of the dental light shown in phantom lines are not elements of the design of my new invention.

1 Claim, 4 Drawing Sheets

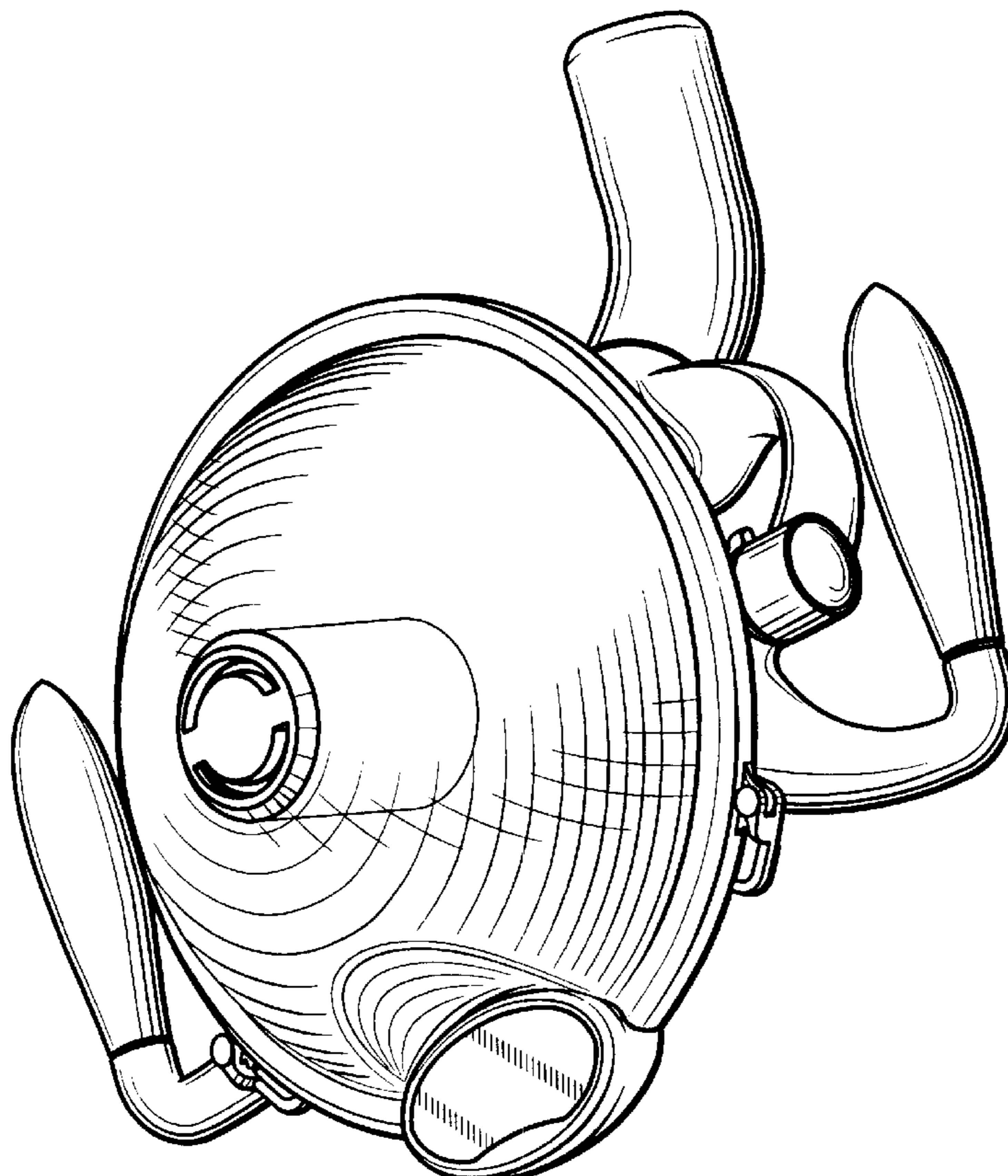

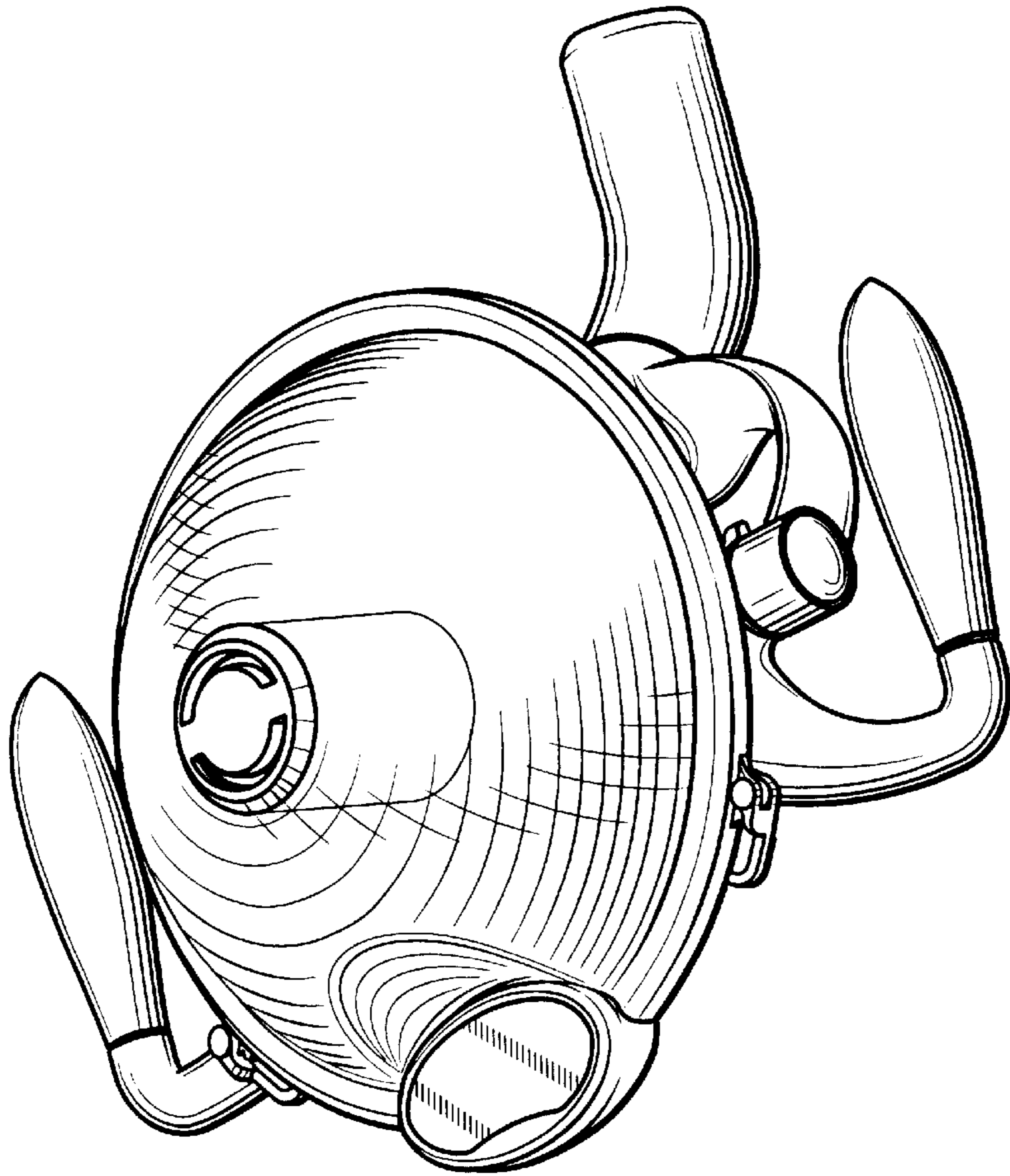

FIG. 1

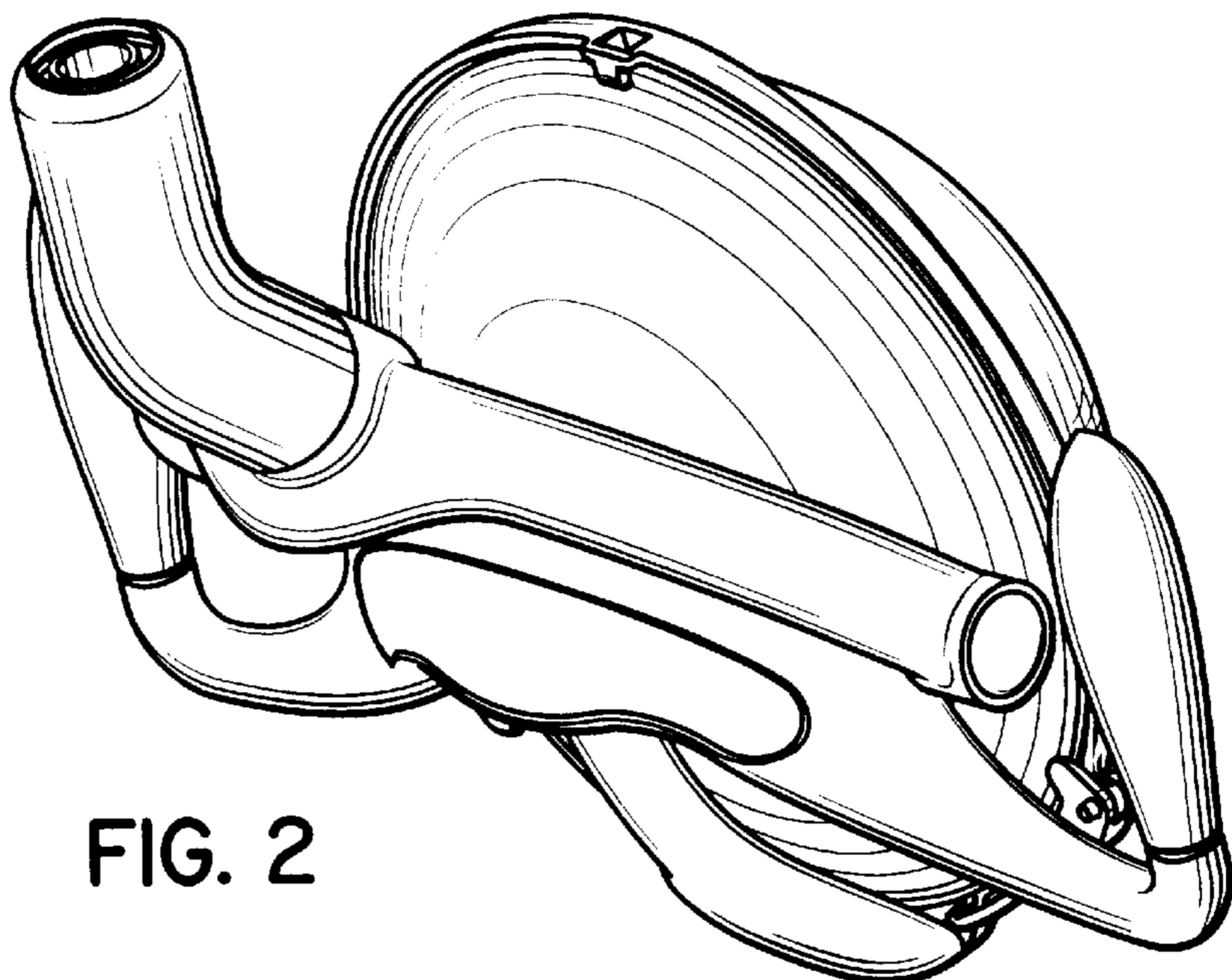

FIG. 2

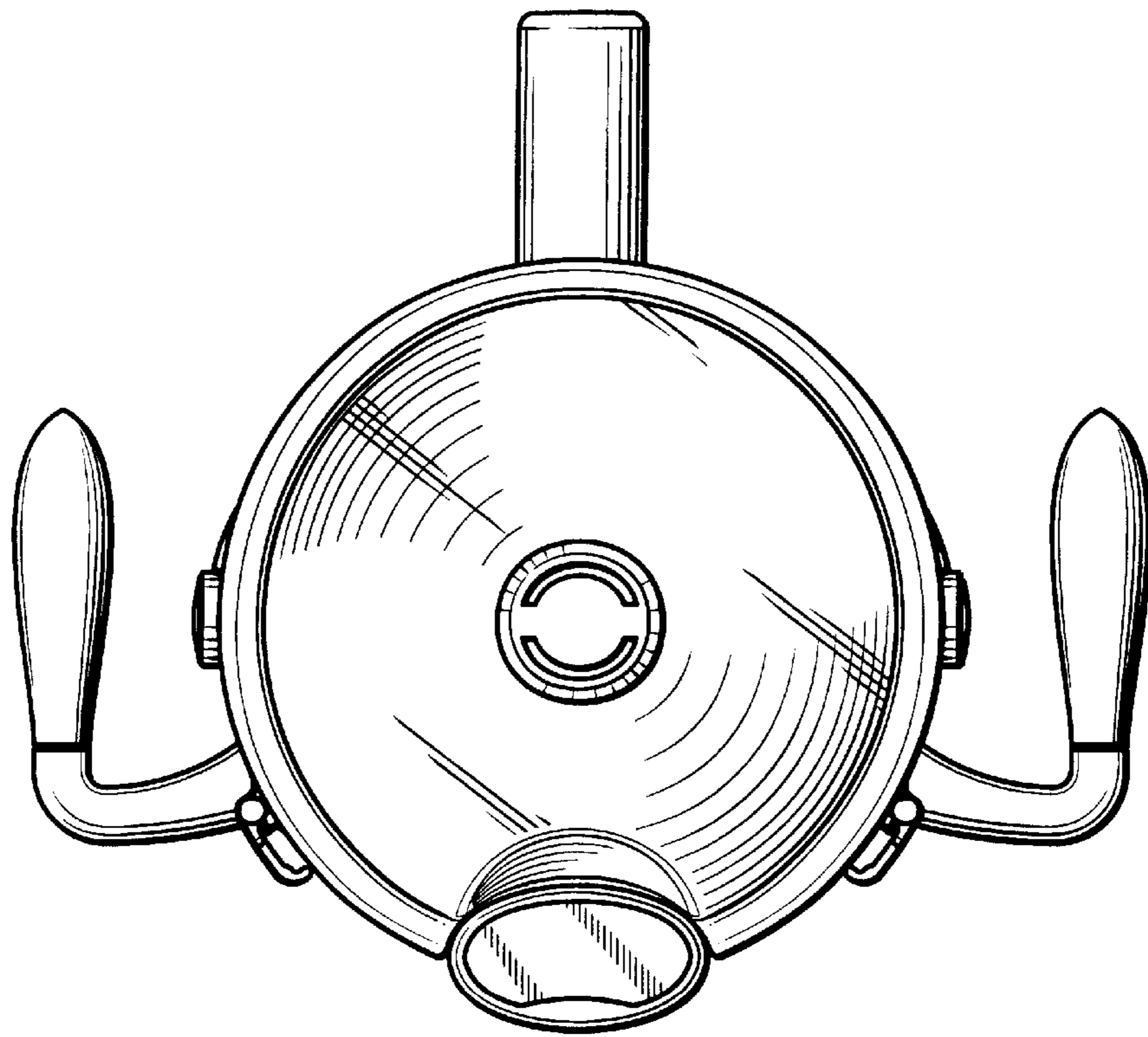

FIG. 3

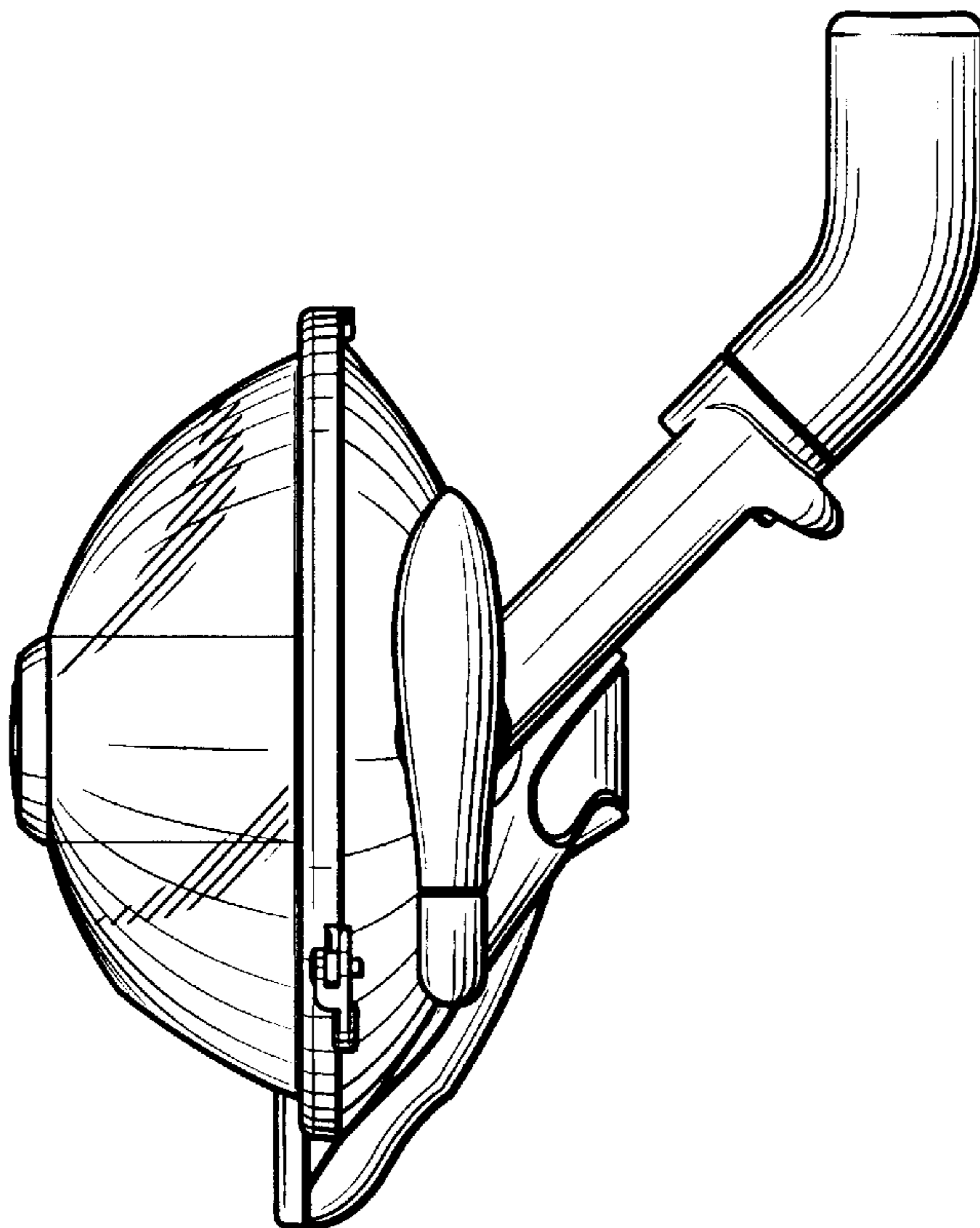

FIG. 4

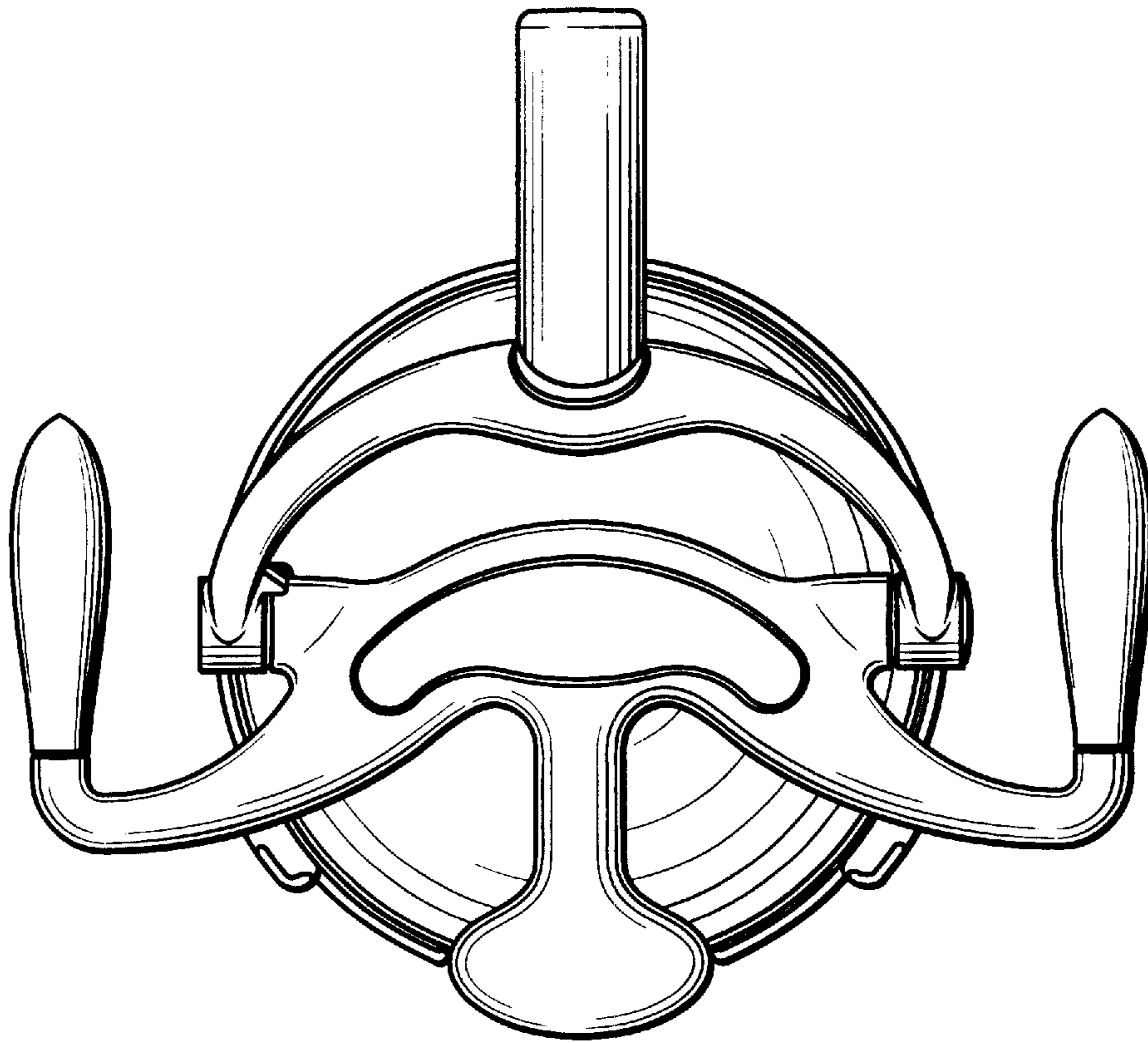

FIG. 5

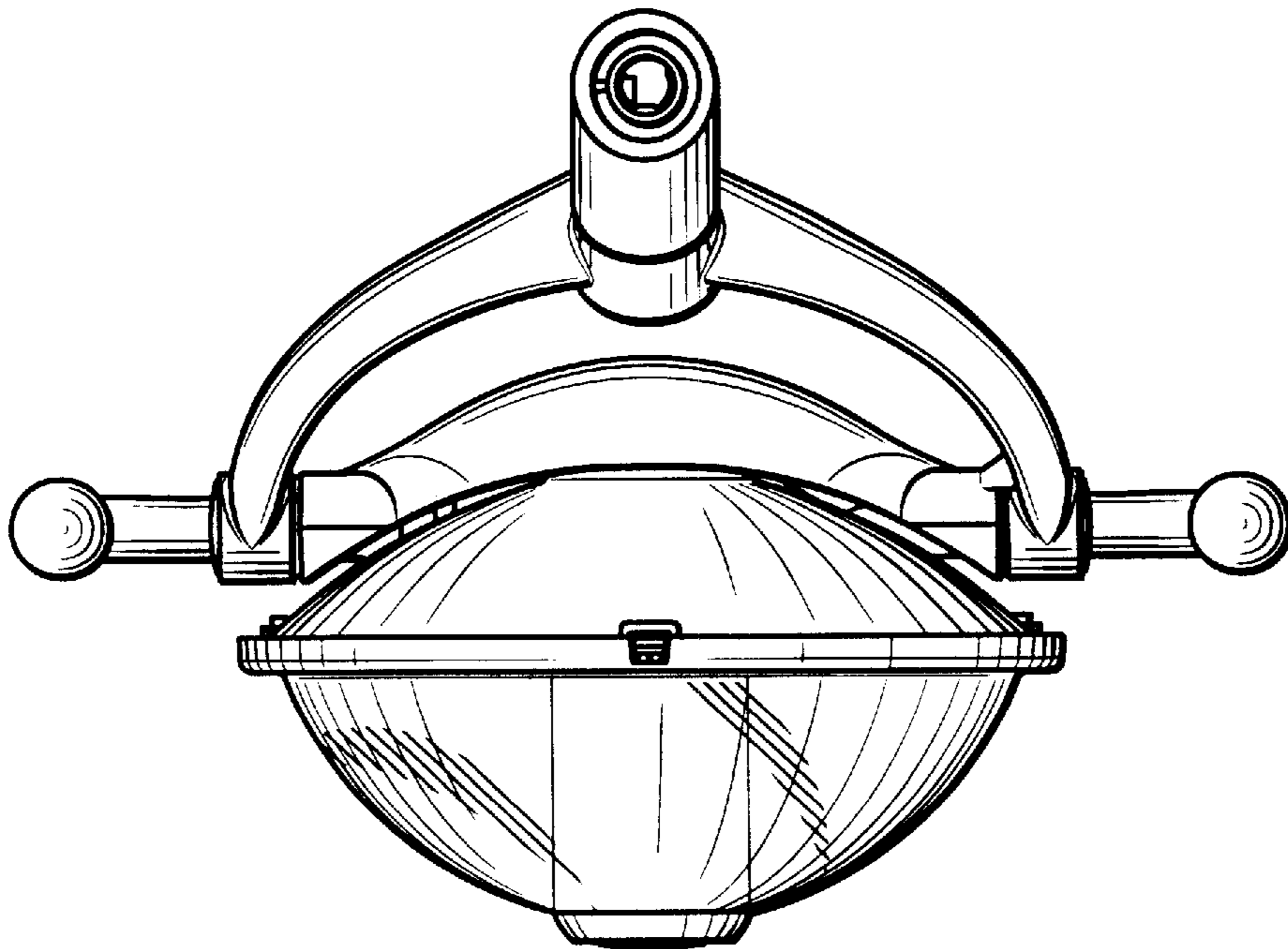

FIG. 6

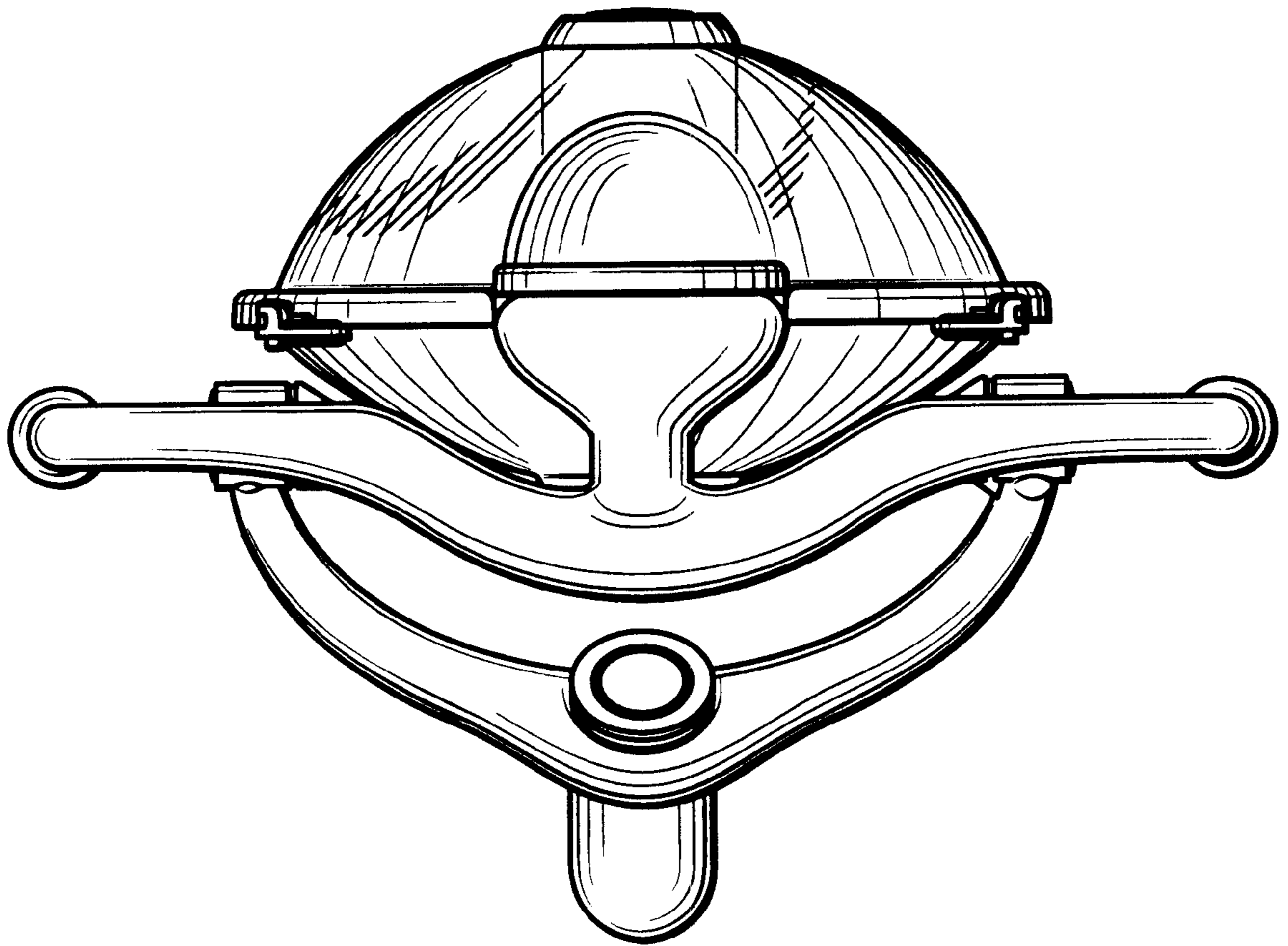

FIG. 7