



US00D463002S

(12) **United States Design Patent**
Tang et al.

(10) **Patent No.:** **US D463,002 S**

(45) **Date of Patent:** **** Sep. 17, 2002**

(54) **PUTTER HEAD**

(75) Inventors: **Larry G. Tang**, Carlsbad, CA (US);
Joshua G. Breier, Vista, CA (US)

(73) Assignee: **Callaway Golf Company**, Carlsbad,
CA (US)

(**) Term: **14 Years**

(21) Appl. No.: **29/157,657**

(22) Filed: **Mar. 22, 2002**

Related U.S. Application Data

(63) Continuation-in-part of application No. 29/148,529, filed on
Sep. 20, 2001, now Pat. No. Des. 457,586.

(51) **LOC (7) Cl.** **21-02**

(52) **U.S. Cl.** **D21/759**

(58) **Field of Search** D21/736-746,
D21/759; 473/251-256, 324, 327-331,
340, 341

(56) **References Cited**

U.S. PATENT DOCUMENTS

- 1,485,272 A 2/1924 Kinsman
- 1,526,951 A 2/1925 Beaumont
- 1,546,612 A 7/1925 Barnes
- 1,569,295 A 1/1926 Munson
- 1,652,404 A 9/1927 Graveure
- 1,654,916 A 1/1928 Boyce
- 1,666,174 A 4/1928 Holland
- 1,703,199 A 2/1929 McClure
- D85,510 S 6/1931 Beach
- D90,924 S 10/1933 Replogle
- 1,960,110 A 5/1934 Iles
- 2,002,631 A 5/1935 Fiondella
- D95,819 S 6/1935 Gourlay
- 2,056,335 A 10/1936 Wettlaufer
- 2,057,821 A 10/1936 Costello
- D104,495 S 5/1937 Gallagher
- 2,156,025 A 4/1939 Paul
- 2,447,967 A 8/1948 Stone

- 2,478,468 A 8/1949 Drake
- 2,708,579 A 5/1955 Hugman
- D176,246 S 12/1955 Gillon
- D179,002 S 10/1956 Hoffmeister
- 2,781,197 A 2/1957 Wiley
- 2,838,312 A 6/1958 Drake
- 2,957,696 A 10/1960 Warpotas
- 3,021,141 A 2/1962 Polsky et al.
- 3,064,975 A 11/1962 Smith
- D200,585 S 3/1965 Cefaly
- 3,194,564 A 7/1965 Swan
- 3,220,733 A 11/1965 Salerby
- 3,300,241 A 1/1967 Eberwein et al.
- 3,310,879 A 3/1967 Brzezinski et al.
- 3,328,032 A 6/1967 Griswold
- 3,333,854 A 8/1967 White
- 3,343,839 A 9/1967 Borah
- D209,294 S 11/1967 Hitt
- 3,357,705 A 12/1967 Blanchard
- 3,408,074 A 10/1968 Antonious
- 3,411,789 A 11/1968 Wariner
- D217,487 S 5/1970 Blake
- 3,512,262 A 5/1970 Smyk et al.
- 3,578,332 A 5/1971 Caldwell
- 3,632,112 A 1/1972 Jacobs
- 3,708,172 A 1/1973 Rango
- 3,779,398 A 12/1973 Hunter

(List continued on next page.)

Primary Examiner—Mitchell Siegel

(74) *Attorney, Agent, or Firm*—Michael A. Catania

(57) **CLAIM**

The ornamental design for a putter head, as shown and described.

DESCRIPTION

FIG. 1 is a top plan view of a putter head thereof;
FIG. 2 is a bottom plan view thereof;
FIG. 3 is a front view thereof;
FIG. 4 is a back view thereof;
FIG. 5 is a right side view thereof; and,
FIG. 6 is a left side view thereof.

1 Claim, 2 Drawing Sheets

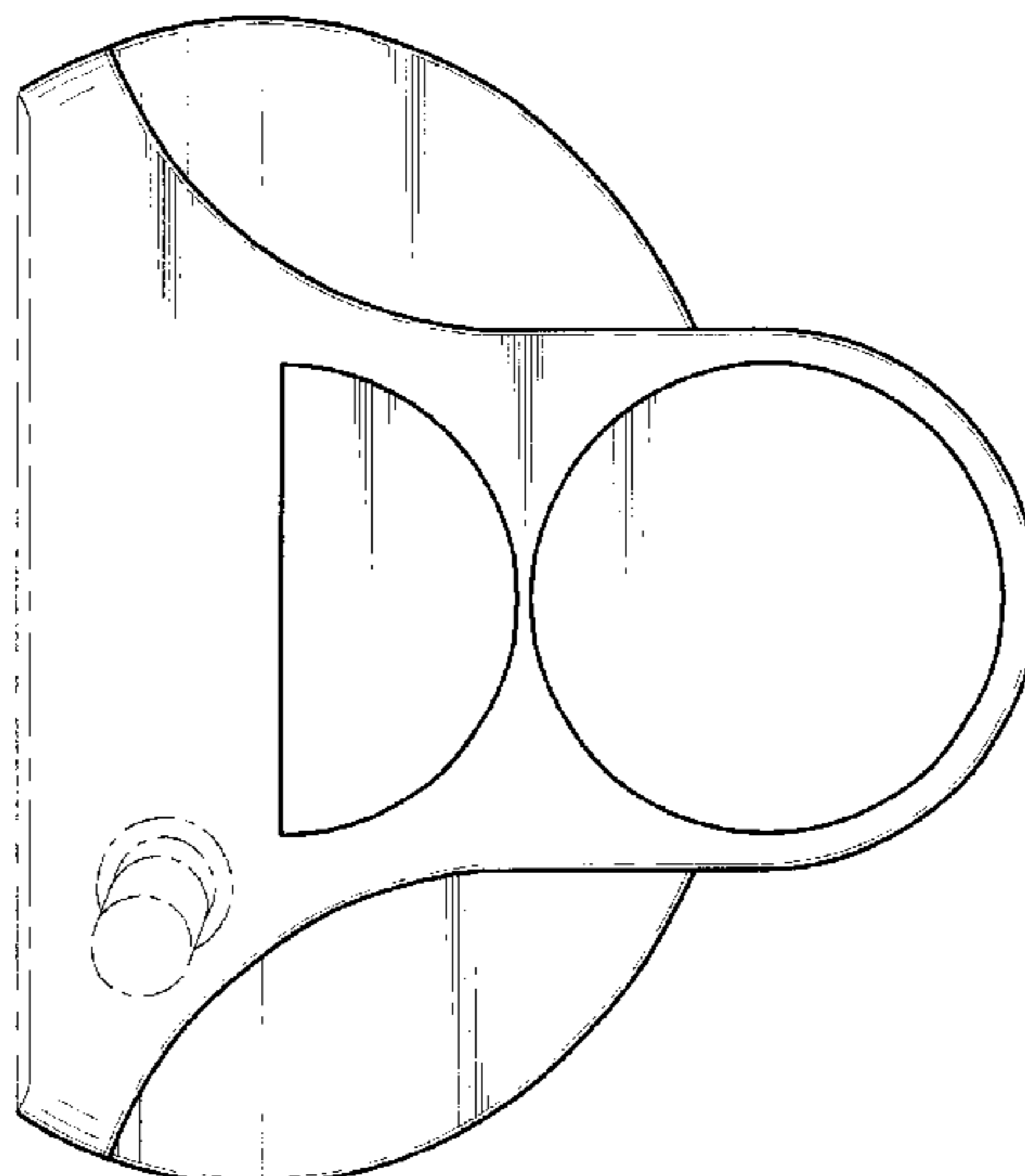

US D463,002 S

Page 2

U.S. PATENT DOCUMENTS

D230,293 S	*	2/1974	Gall	D21/745	4,278,254 A	7/1981	Simjian	
D230,294 S	*	2/1974	Gall	D21/745	4,314,701 A	2/1982	Swanson	
D230,615 S		3/1974	Delgadillo		4,411,431 A	10/1983	Judice	
3,806,129 A		4/1974	Burrows		4,444,395 A	4/1984	Reiss	
3,841,640 A		10/1974	Gaulocher		4,688,798 A	8/1987	Pelz	
3,841,641 A		10/1974	Bennett		D309,765 S	8/1990	Pelz	
D233,616 S		11/1974	Verzillo		D309,766 S	8/1990	Pelz	
3,884,477 A		5/1975	Bianco		D317,034 S	5/1991	Pelz	
3,918,720 A		11/1975	Gordos		D317,962 S	7/1991	Pelz	
D241,563 S		9/1976	McCord		5,685,784 A	*	11/1997	Butler 473/340
D245,437 S		8/1977	Thiel		D395,692 S	*	6/1998	Butler D21/742
D248,050 S		5/1978	Muehl		D422,328 S	*	4/2000	Lannoch D21/743
D252,221 S		6/1979	Mariani		D448,437 S	*	9/2001	Colucci D21/736

* cited by examiner

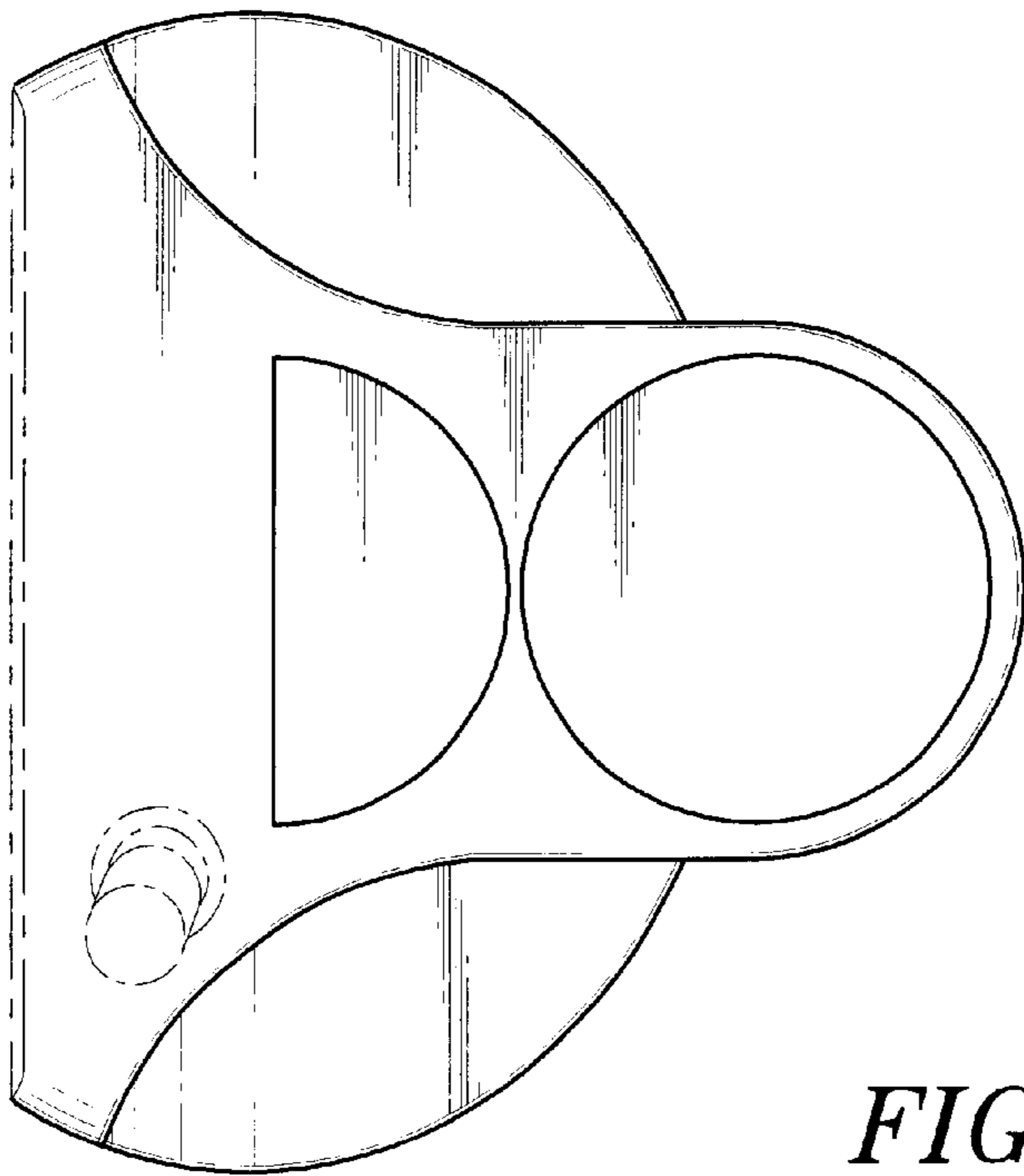

FIG. 1

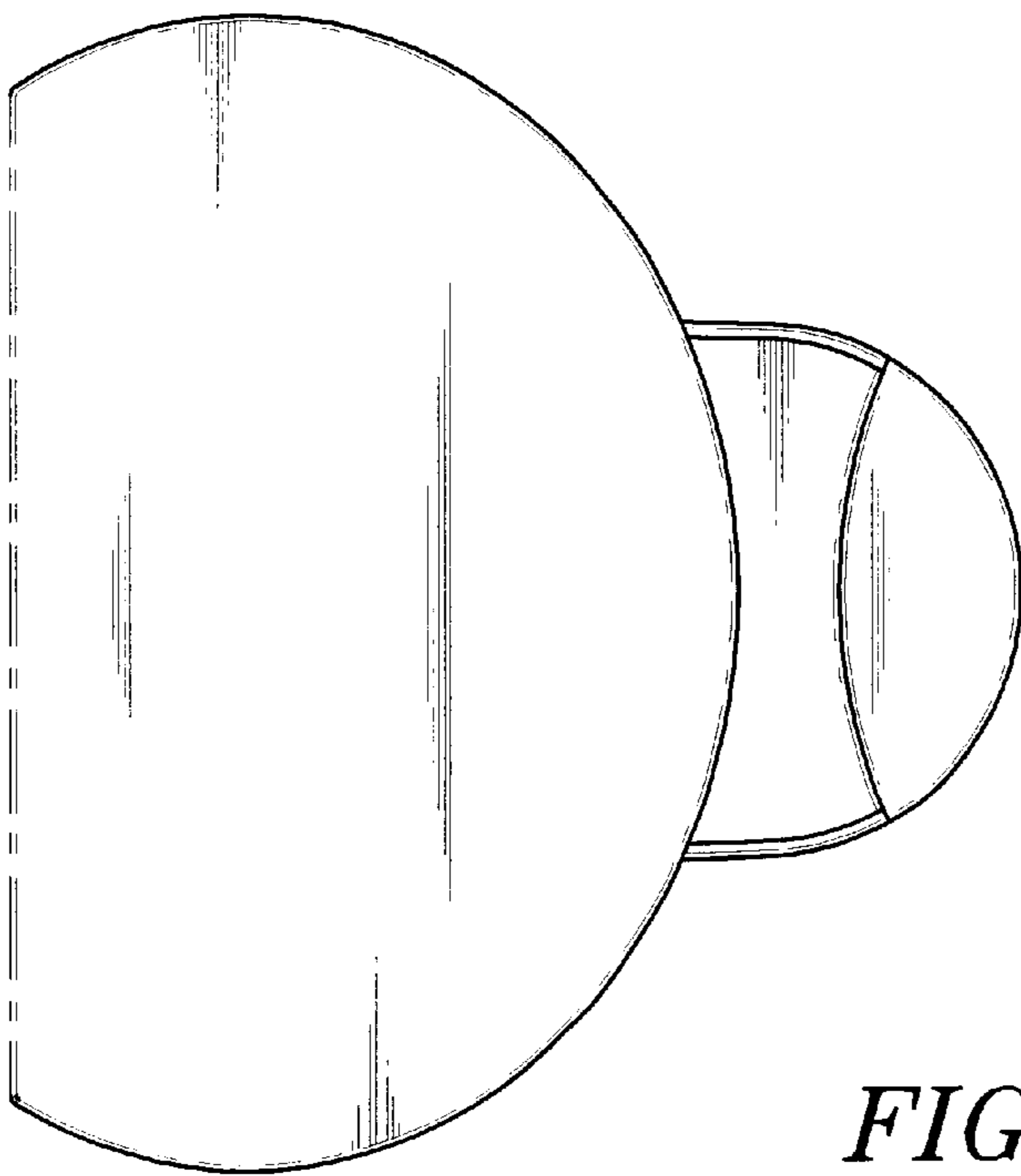

FIG. 2

FIG. 3

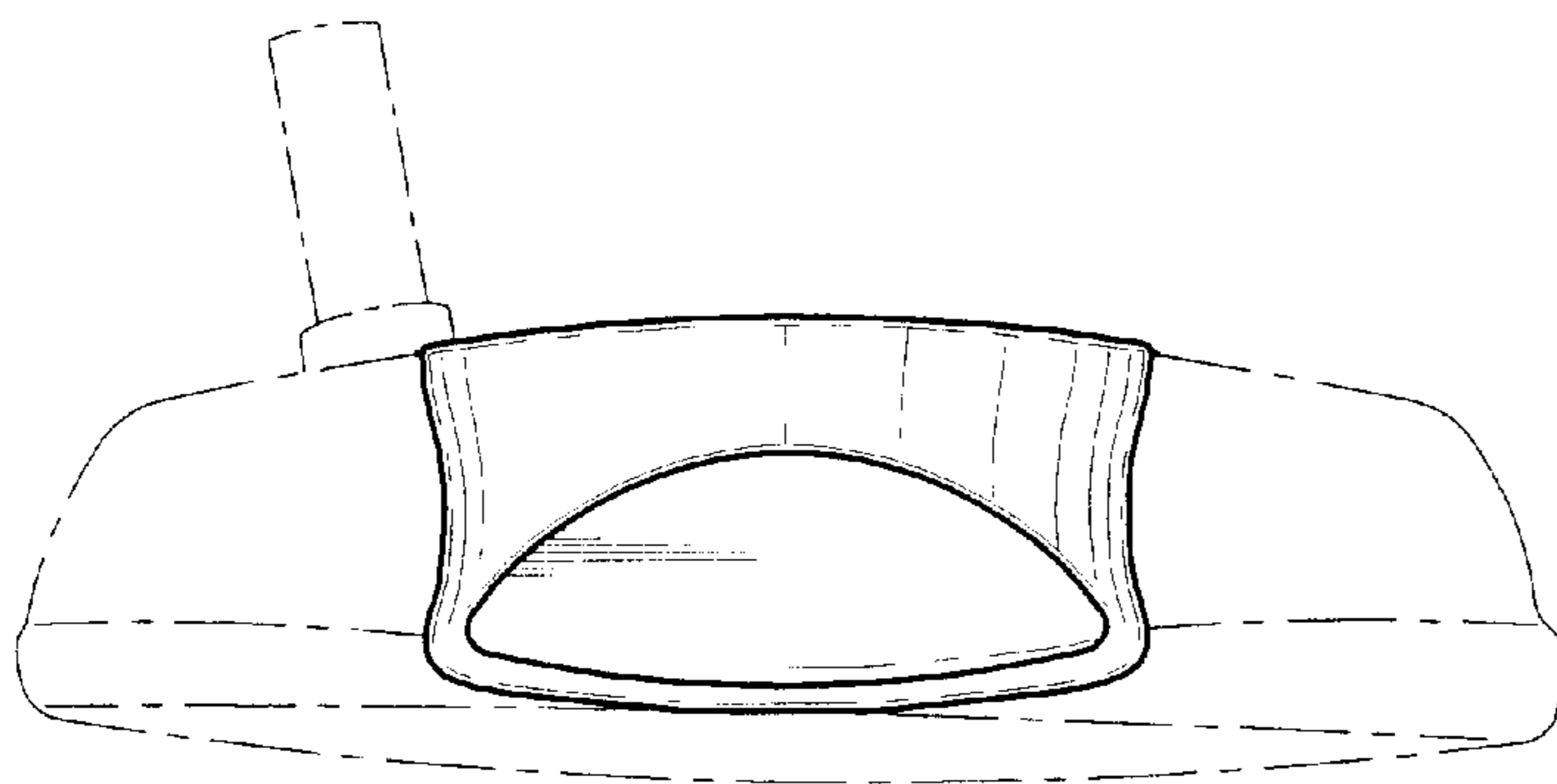
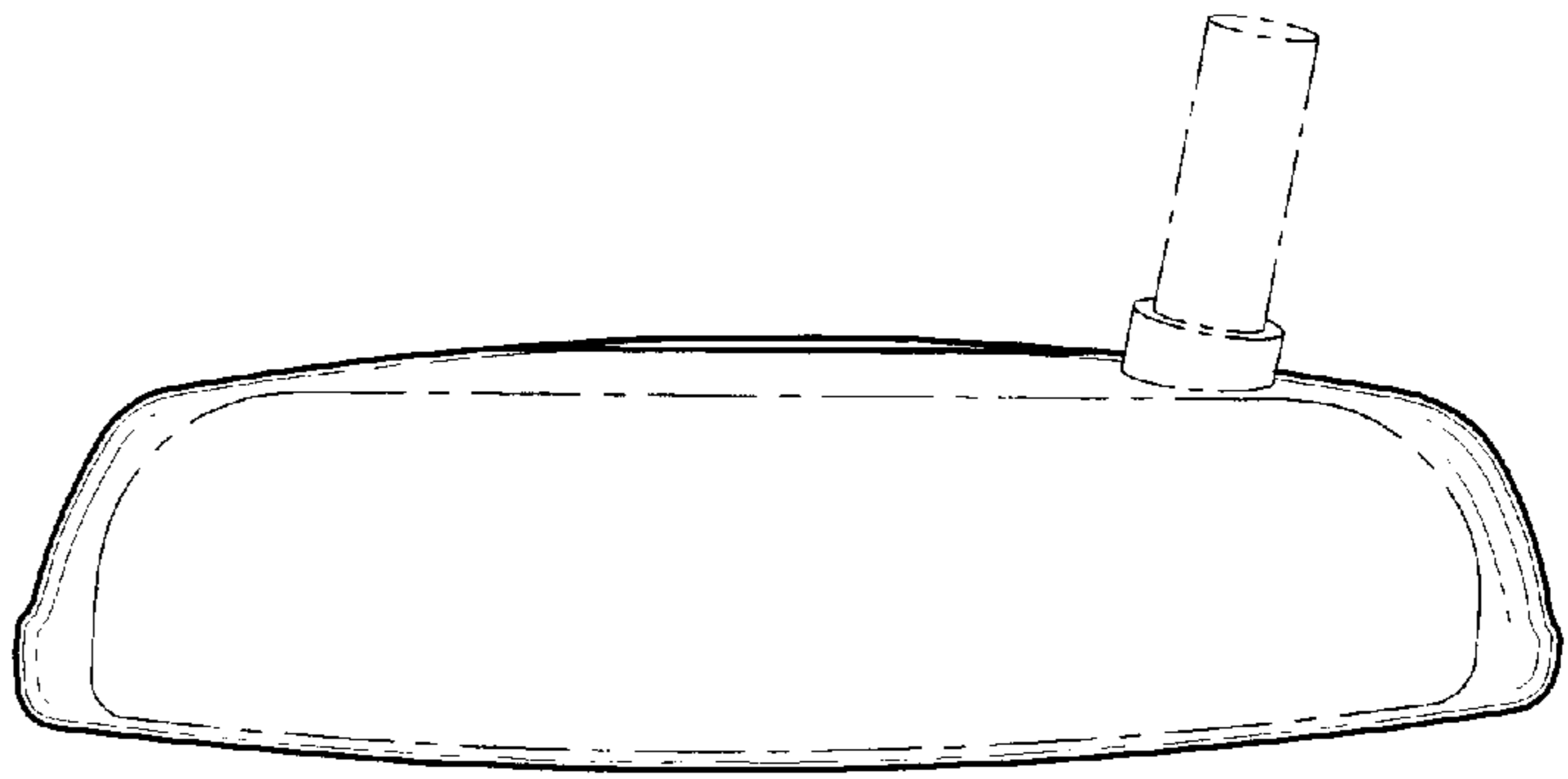

FIG. 4

FIG. 5

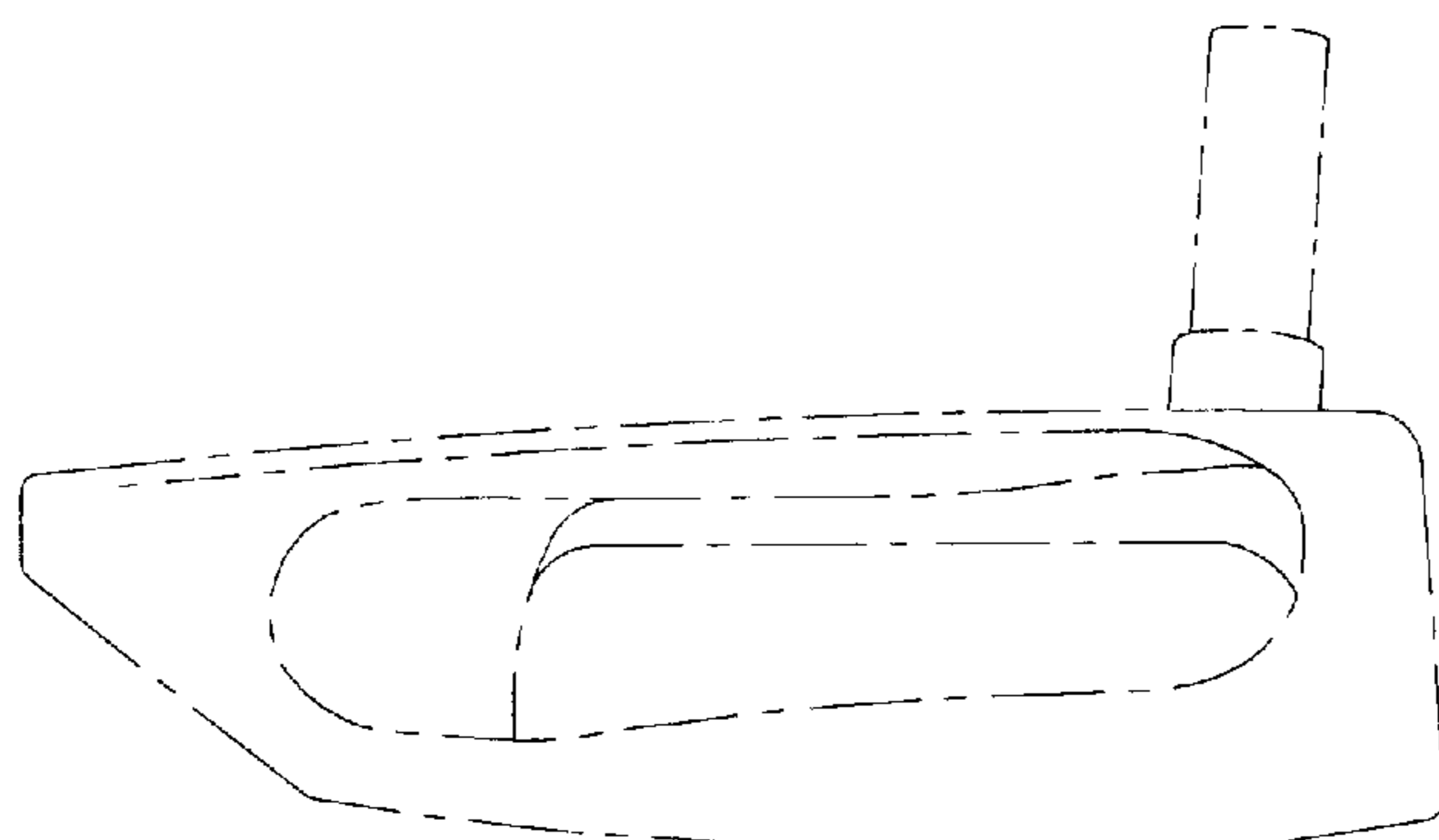
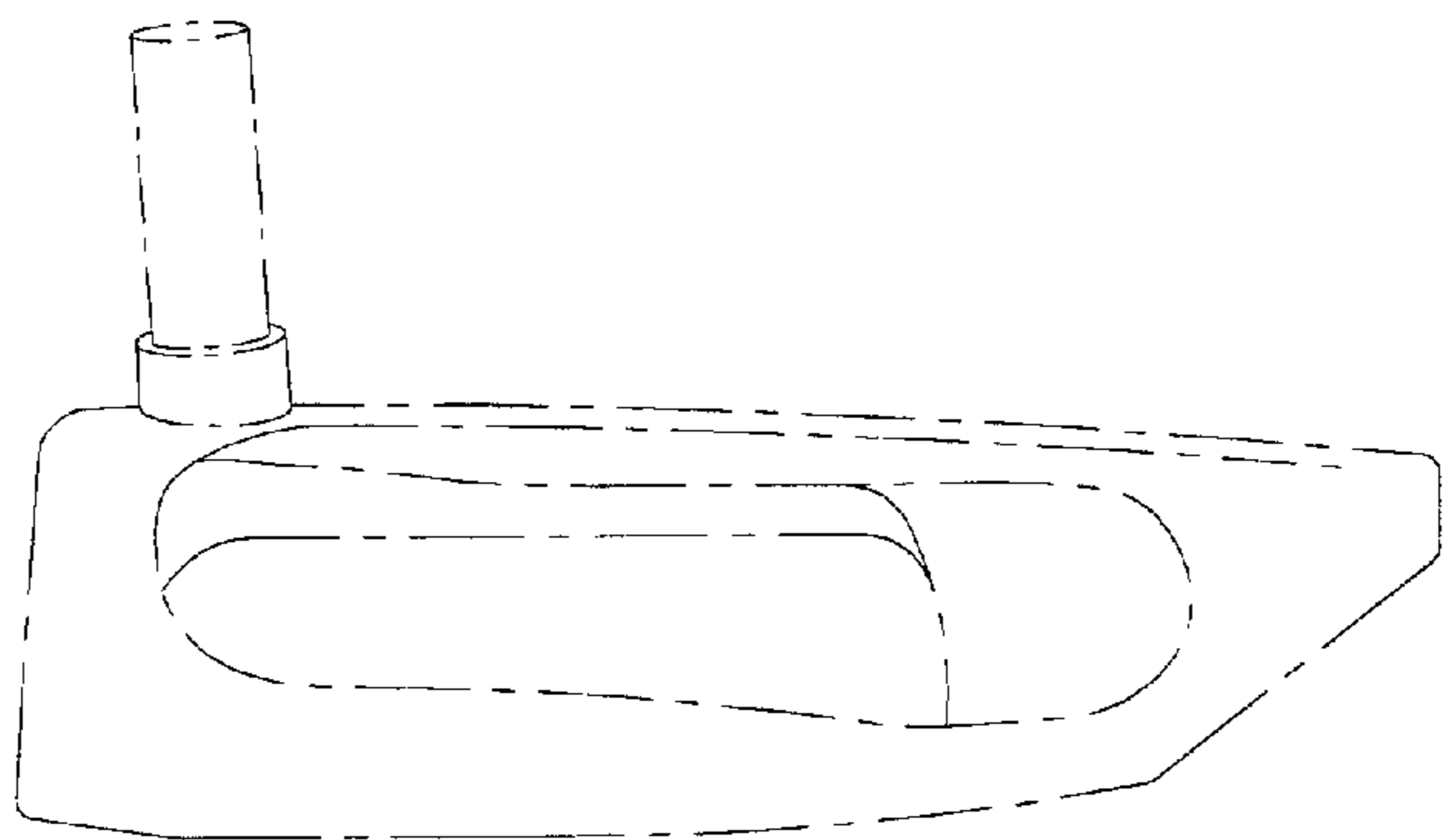

FIG. 6