



US00D462965S

(12) **United States Design Patent** (10) **Patent No.:** **US D462,965 S**
Pentz (45) **Date of Patent:** **** *Sep. 17, 2002**

(54) **DATA CARD**

(75) Inventor: **Jamily Pentz**, Tega Cay, SC (US)

(73) Assignee: **Bank of America Corporation**,
Charlotte, NC (US)

(*) Notice: This patent is subject to a terminal disclaimer.

(**) Term: **14 Years**

(21) Appl. No.: **29/141,693**

(22) Filed: **May 11, 2001**

(51) **LOC (7) Cl.** **14-02**

(52) **U.S. Cl.** **D14/436**

(58) **Field of Search** D14/432, 435,
D14/436; 283/106, 107, 108, 75, 900, 904,
82; D19/9, 10

(56) **References Cited**

U.S. PATENT DOCUMENTS

3,230,650	A	1/1966	Orkin	
4,079,883	A	3/1978	Calder	
4,338,805	A	7/1982	Nygren	
4,443,027	A	4/1984	McNeely et al.	
4,682,794	A	* 7/1987	Margolin 283/82

(List continued on next page.)

FOREIGN PATENT DOCUMENTS

WO WO 9311510 A1 6/1993

OTHER PUBLICATIONS

Identification cards—Physical characteristics, ISO/IEC, 7810: 1995(E).

Identification cards—Recording technique—Part 2: Magnetic stripe—Low coercivity, ISO/IEC, 7811-2: 2001(E).

Identification cards—Recording technique—Part 3: Location of embossed characters on ID-1 cards, ISO/IEC, 7811-3: 1995(E).

(List continued on next page.)

Primary Examiner—Kay H. Chin

(74) *Attorney, Agent, or Firm*—Michael A. Springs; Covington & Burling

(57) **CLAIM**

The ornamental design for a data card, as shown and described.

DESCRIPTION

FIG. 1 is a perspective view of a data card showing my new design;

FIG. 2 is a top plan view thereof, the bottom being a mirror image;

FIG. 3 is a front elevational view thereof;

FIG. 4 is a left elevational view thereof, the right being a mirror image;

FIG. 5 is a rear elevational view thereof;

FIG. 6 is a perspective view of an alternative embodiment of a data card showing my new design;

FIG. 7 is a front elevational view thereof;

FIG. 8 is a rear elevational view thereof (the top and bottom plan views being identical to FIG. 2 and the left and right elevational views being identical to FIG. 4);

FIG. 9 is a perspective view of an alternative embodiment of a data card showing my new design;

FIG. 10 is a front elevational view thereof;

FIG. 11 is a rear elevational view thereof (the top and bottom plan views being identical to FIG. 2 and the left and right elevational views being identical to FIG. 4);

FIG. 12 is a perspective view of an alternative embodiment of a data card showing my new design;

FIG. 13 is a front elevational view thereof;

FIG. 14 is a rear elevational view thereof (the top and bottom plan views being identical to FIG. 2 and the left and right elevational views being identical to FIG. 4);

FIG. 15 is a perspective view of an alternative embodiment of a data card showing my new design;

FIG. 16 is a front elevational view thereof; and,

FIG. 17 is a rear elevational view thereof (the top and bottom plan views being identical to FIG. 2 and the left and right elevational views being identical to FIG. 4).

1 Claim, 4 Drawing Sheets

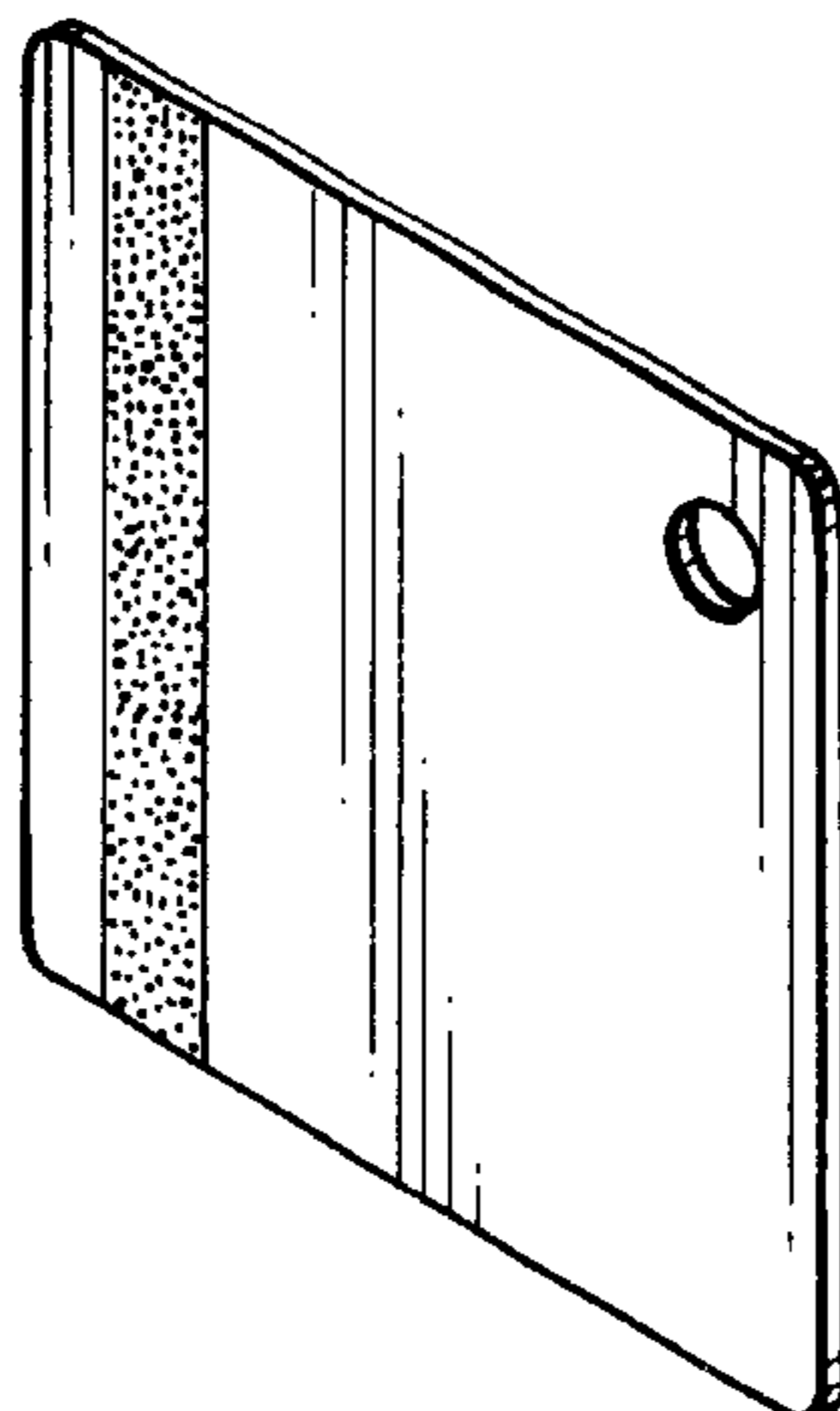

U.S. PATENT DOCUMENTS

4,711,996 A * 12/1987 Drexler 235/468
4,914,281 A 4/1990 Benton et al.
5,061,845 A 10/1991 Pinnavaia
5,090,736 A * 2/1992 Minkus 283/77
5,096,228 A 3/1992 Rinderknecht
5,250,341 A 10/1993 Kobayashi et al.
5,255,941 A * 10/1993 Solomon 283/82
5,700,037 A 12/1997 Keller
5,844,230 A 12/1998 Lalonde
D406,861 S * 3/1999 Leedy, Jr. D19/10
D420,658 S * 2/2000 Eyler D14/436
6,196,594 B1 * 3/2001 Keller 283/82

OTHER PUBLICATIONS

Identification cards—Recording technique—Part 4: Location of read-only magnetic tracks—Tracks 1 and 2, ISO/IEC, 7811-4: 1995(E).
Identification cards—Recording technique—Part 5: Location of read-write magnetic tracks—Track 3, ISO/IEC, 7811-5: 1995(E).
Identification cards—Recording technique—Part 6: Magnetic stripe—High coercivity, ISO/IEC, 7811-6: 2001(E).
Photocopy of a Metro farecard.
Photocopy of grocery discount card (2 pages).

* cited by examiner

FIG. 1

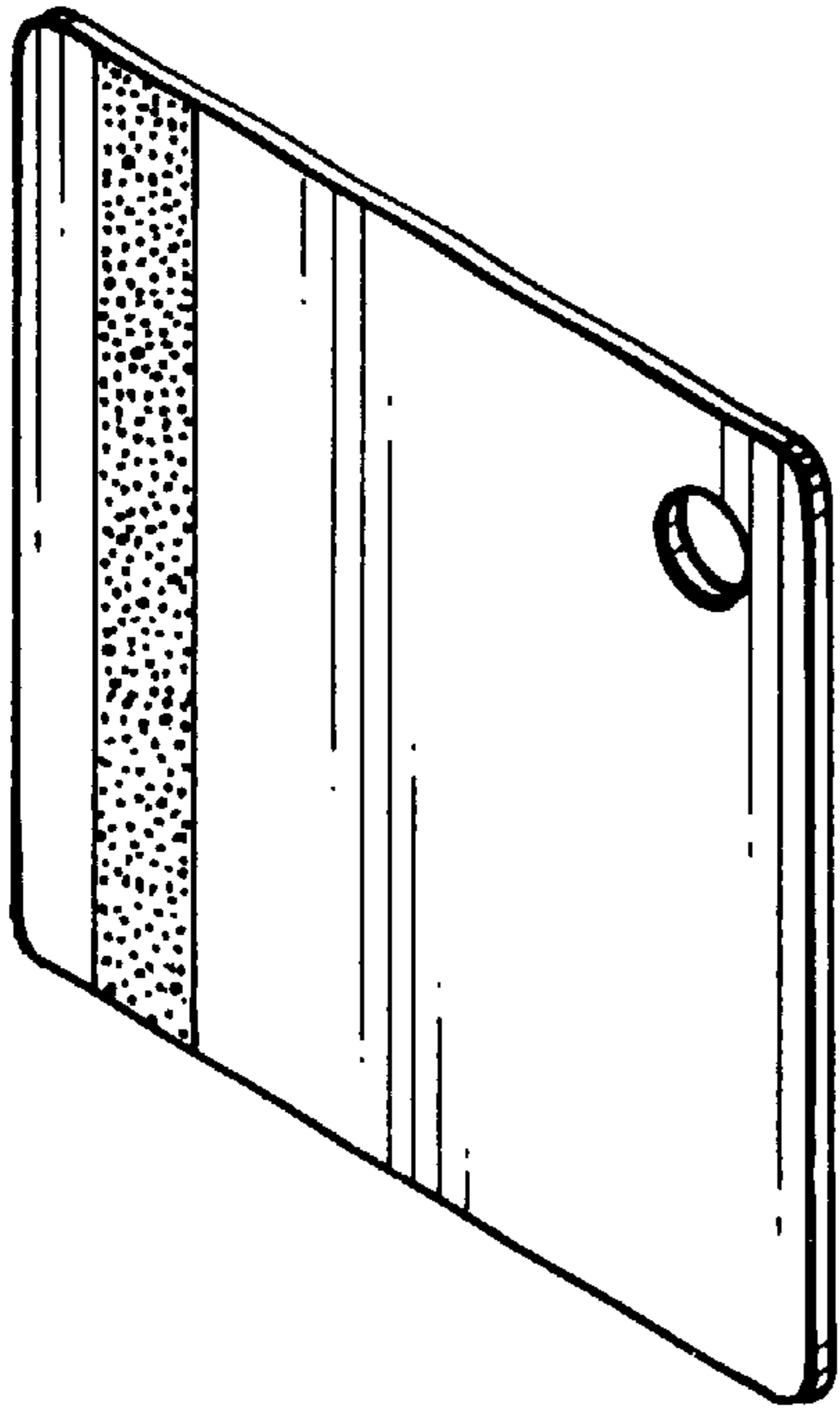

FIG. 2

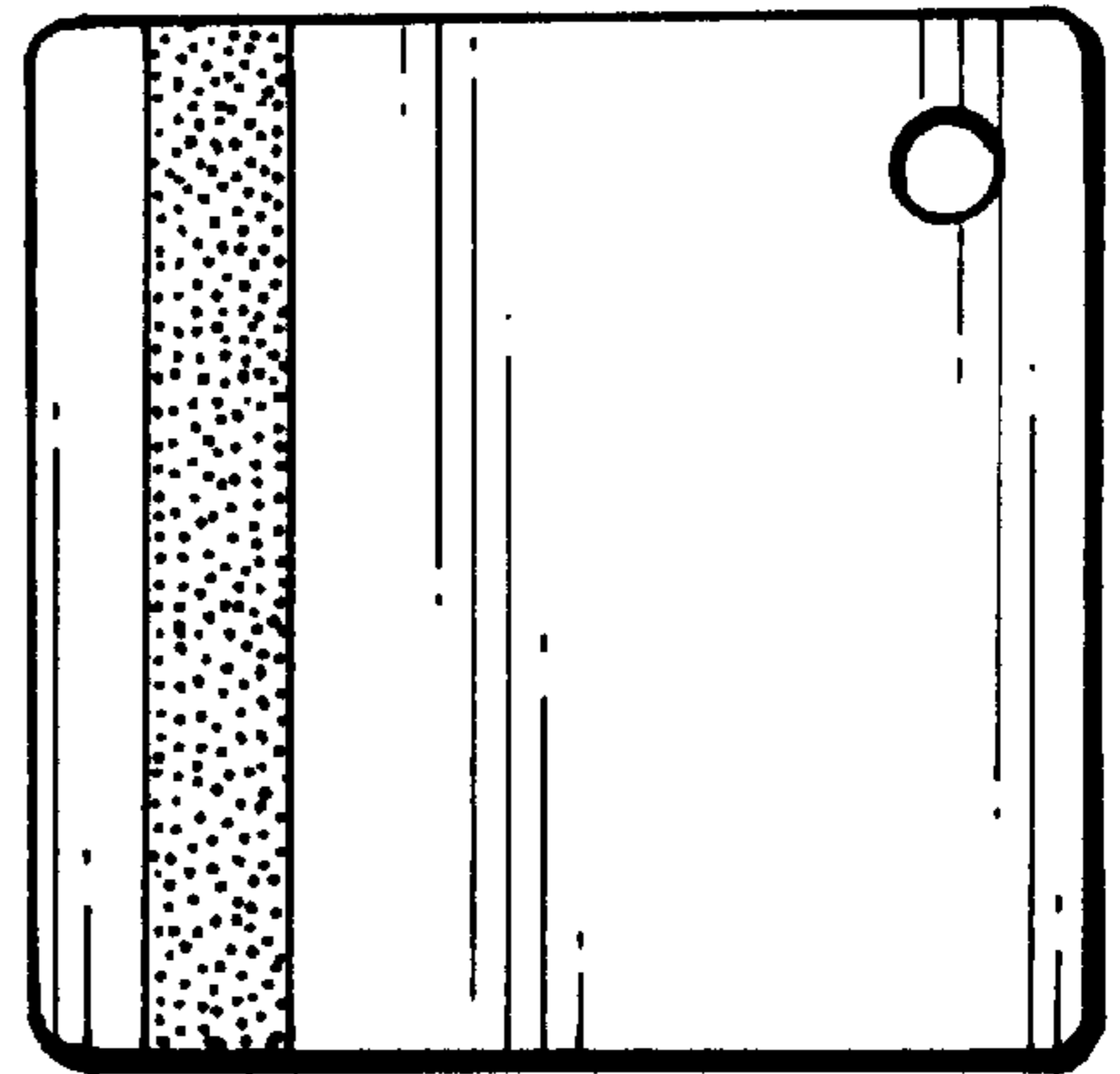
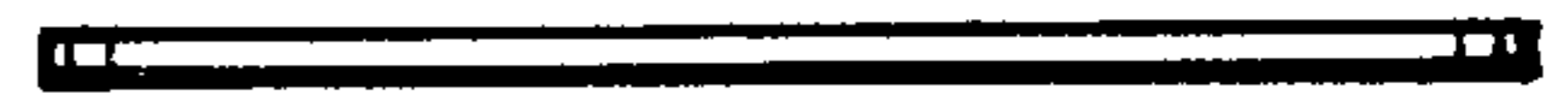

FIG. 3



FIG. 4

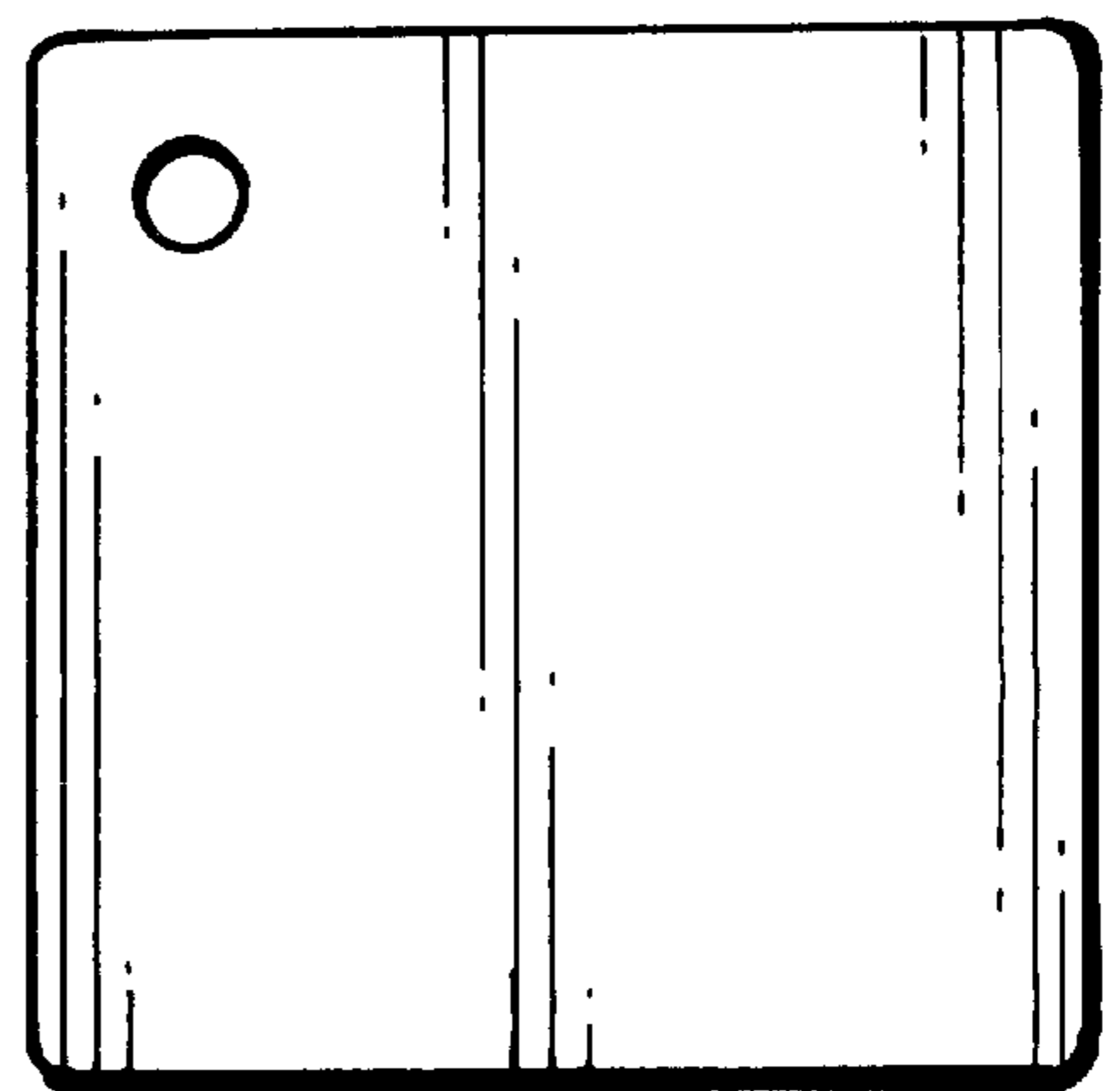

FIG. 5

FIG. 6

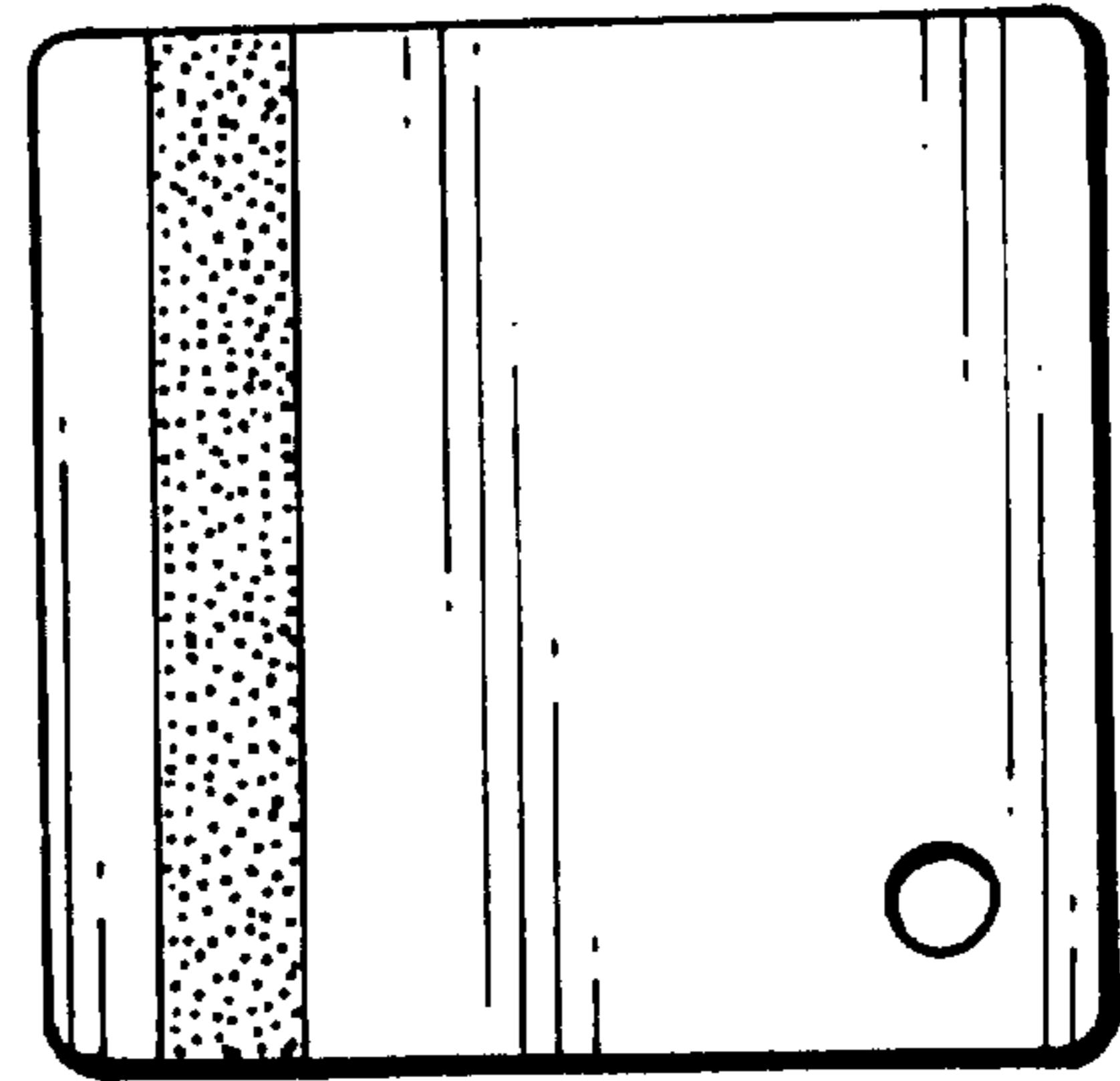
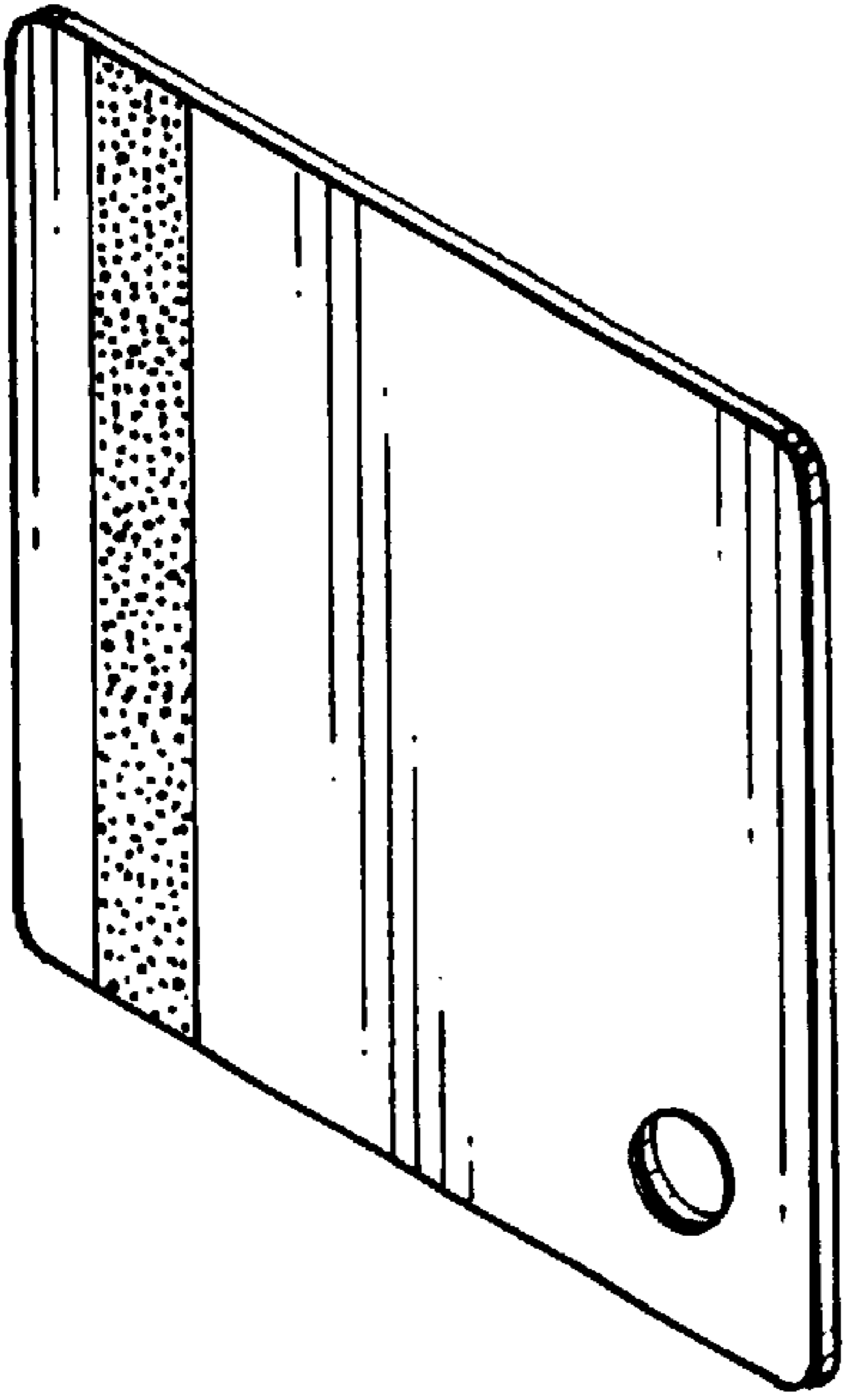

FIG. 7

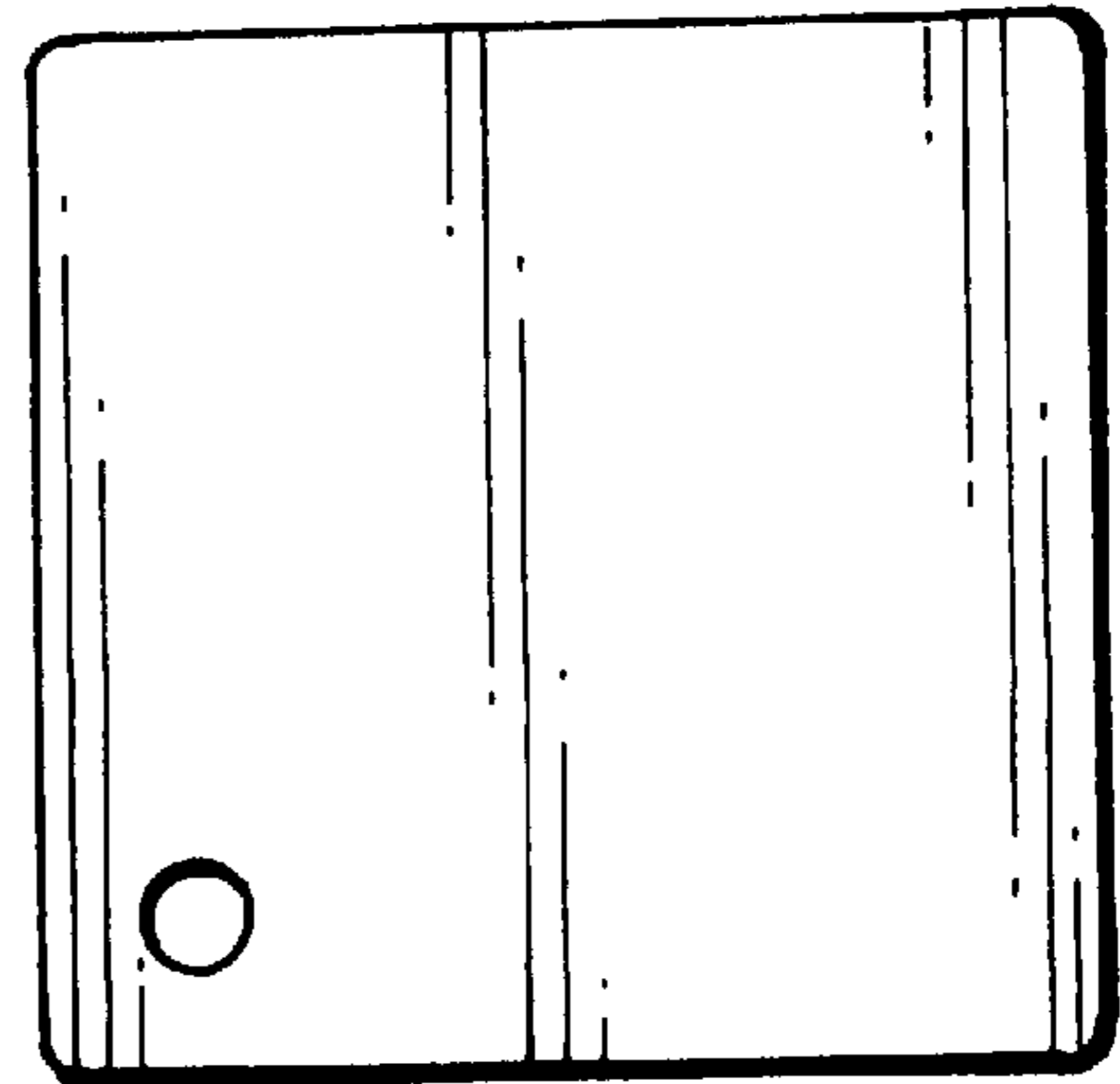

FIG. 8

FIG. 9

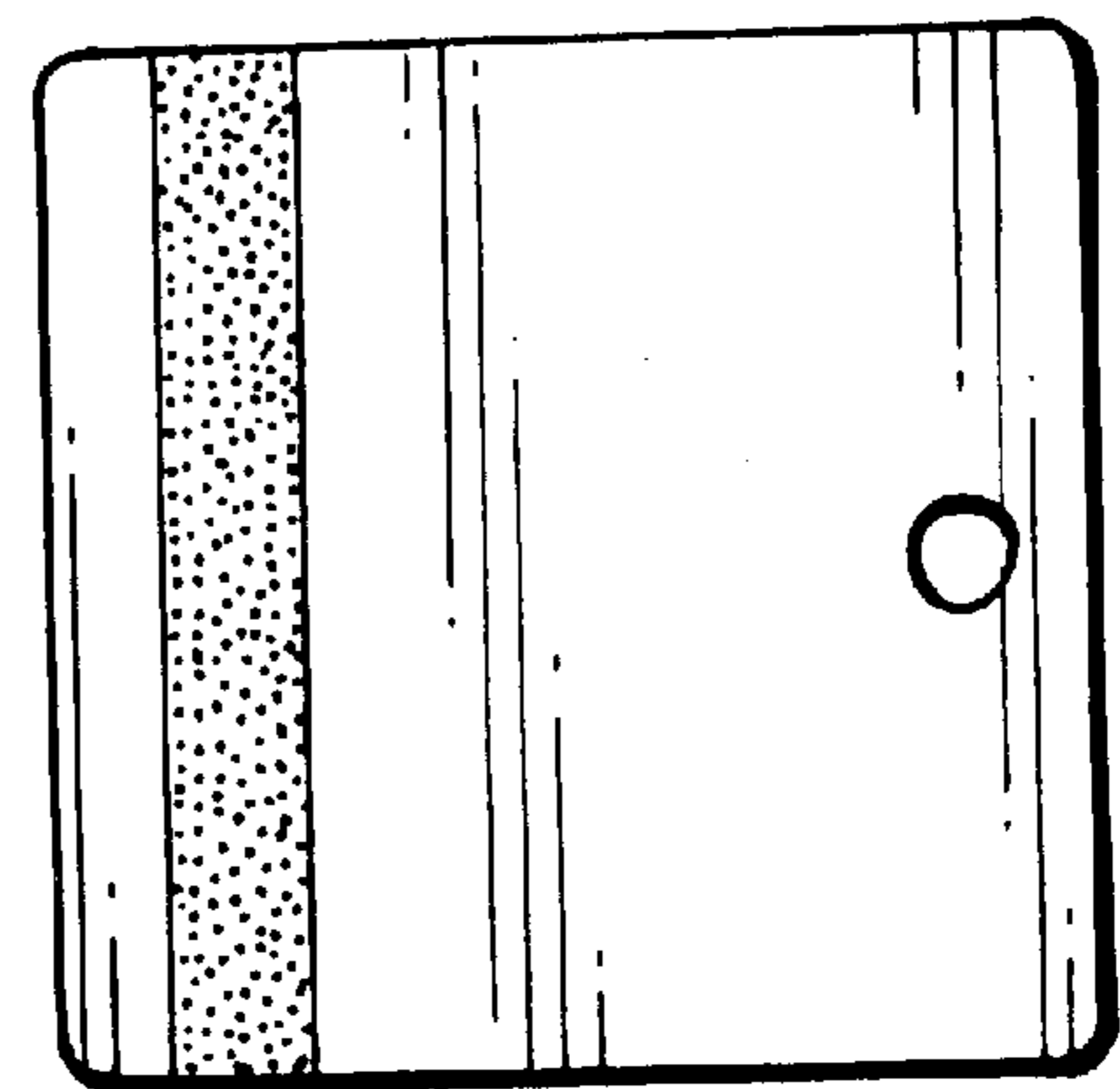
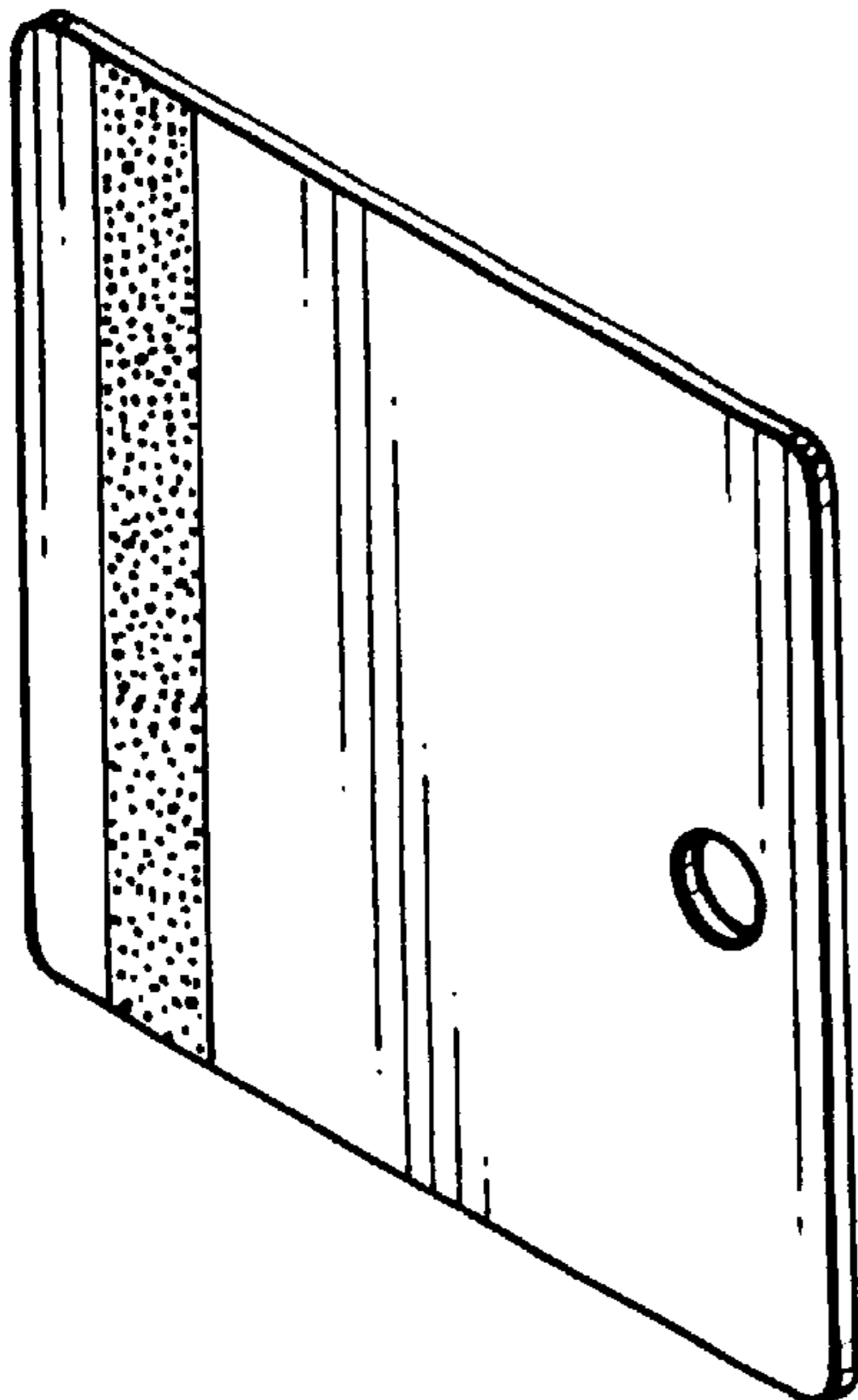

FIG. 10

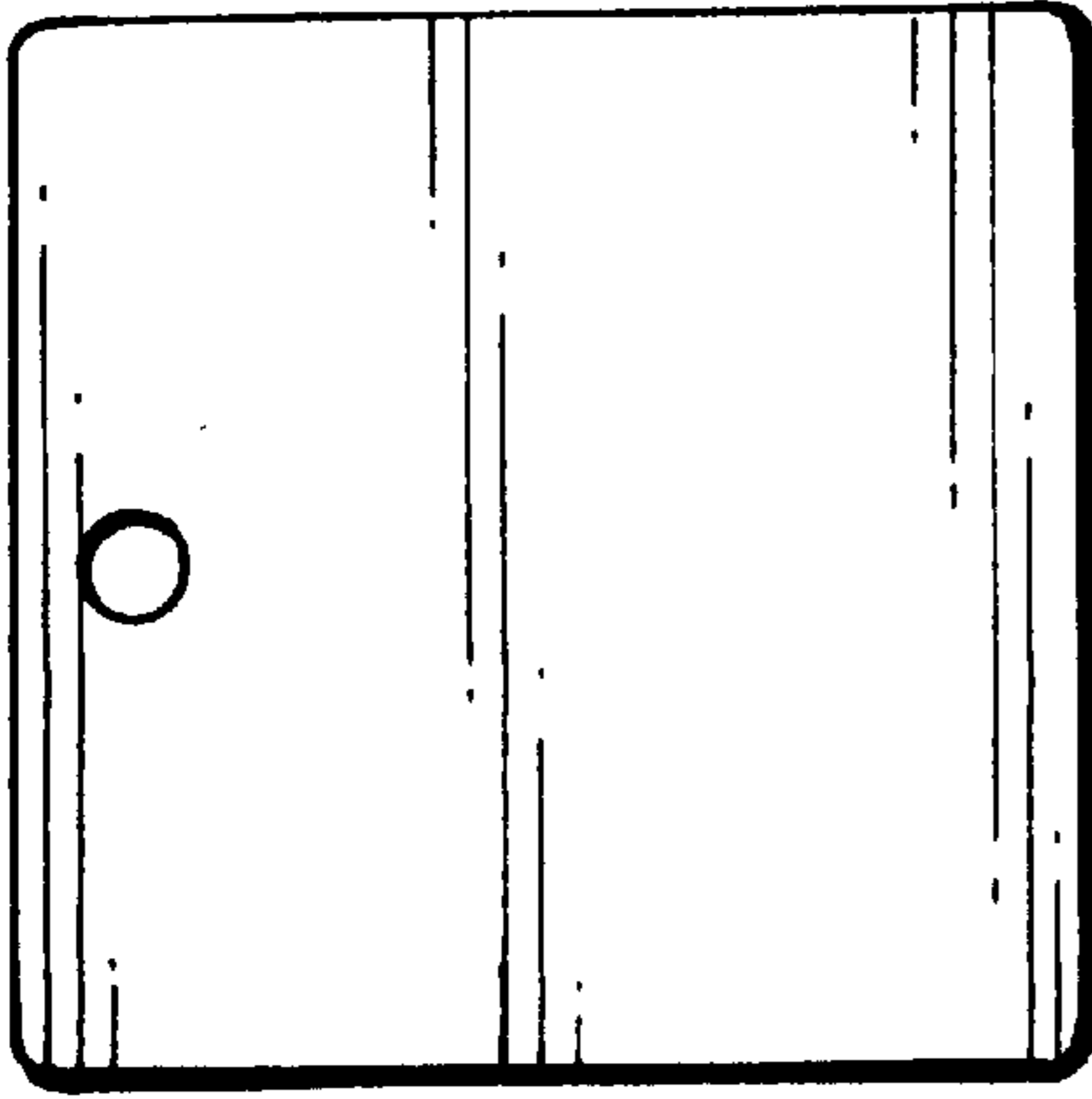

FIG. 11

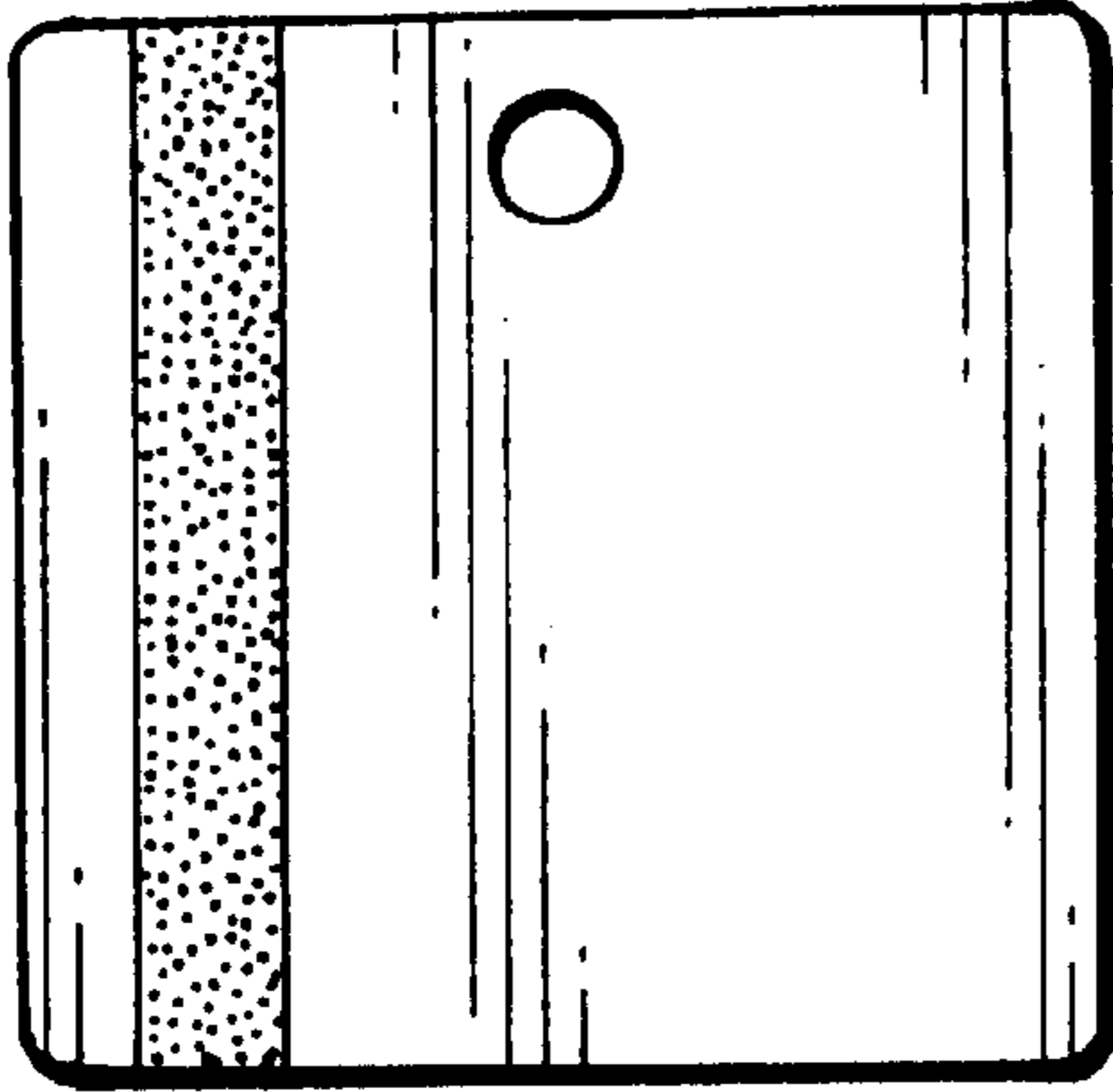

FIG. 13

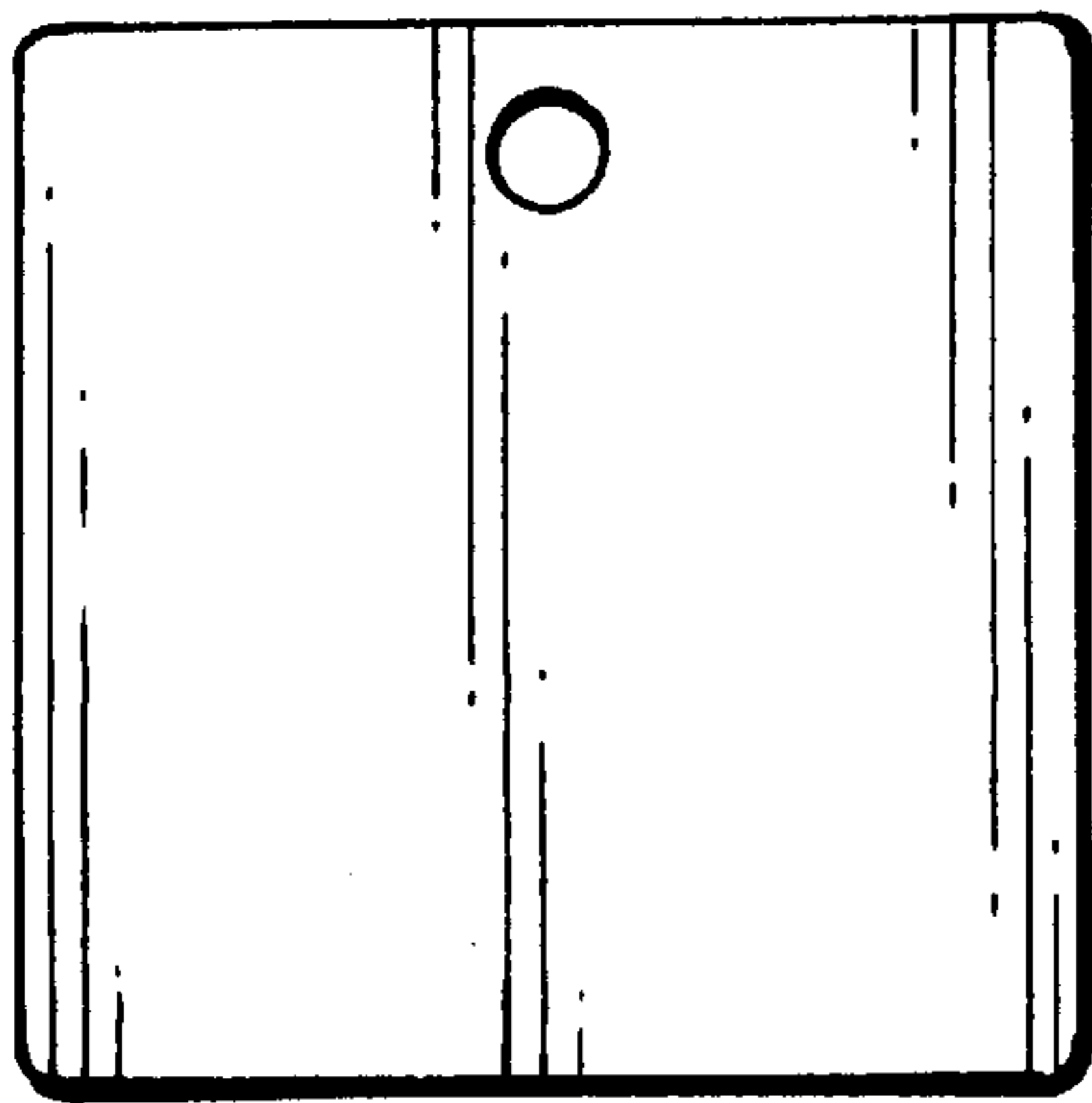

FIG. 14

FIG. 12

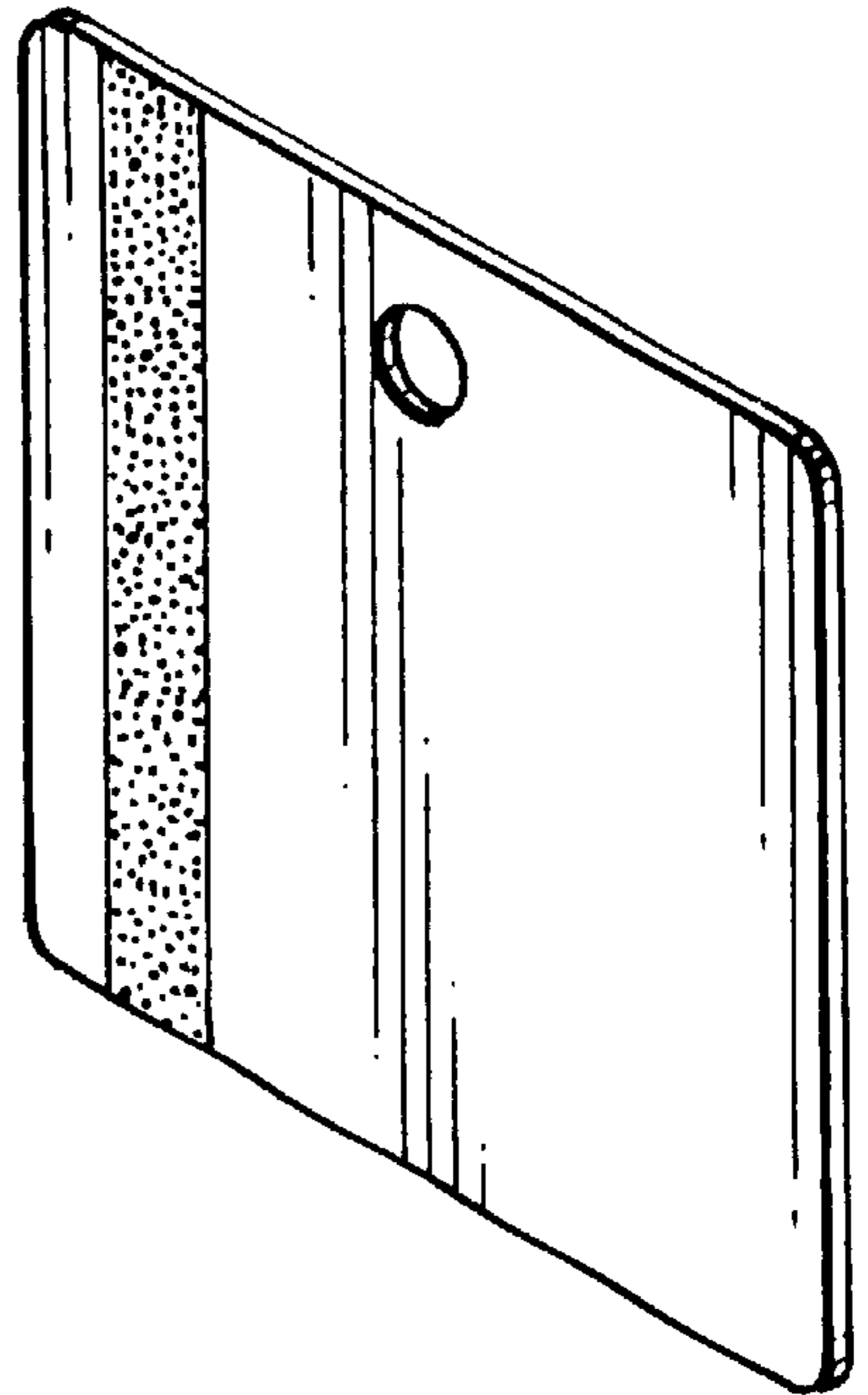
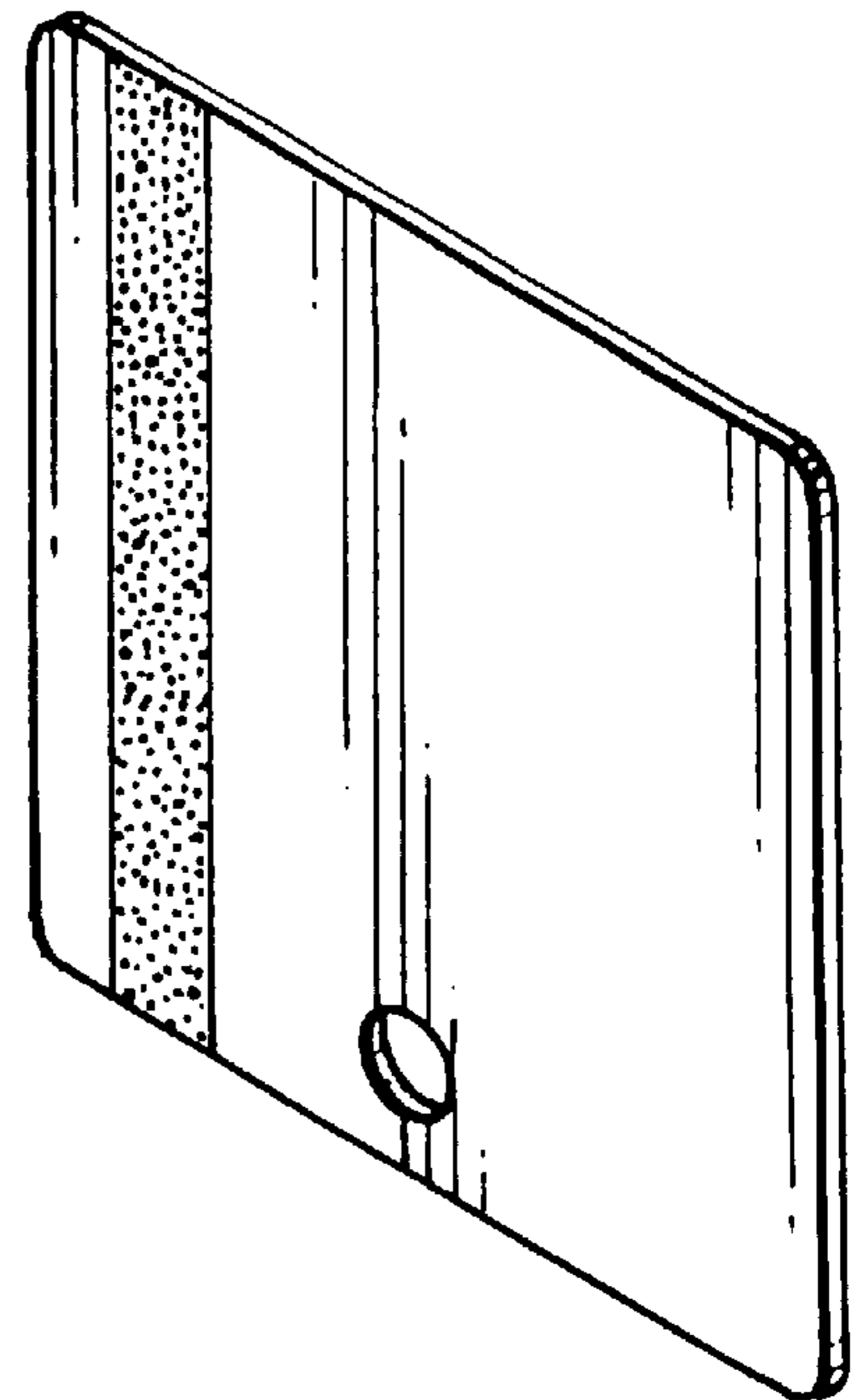

FIG. 15



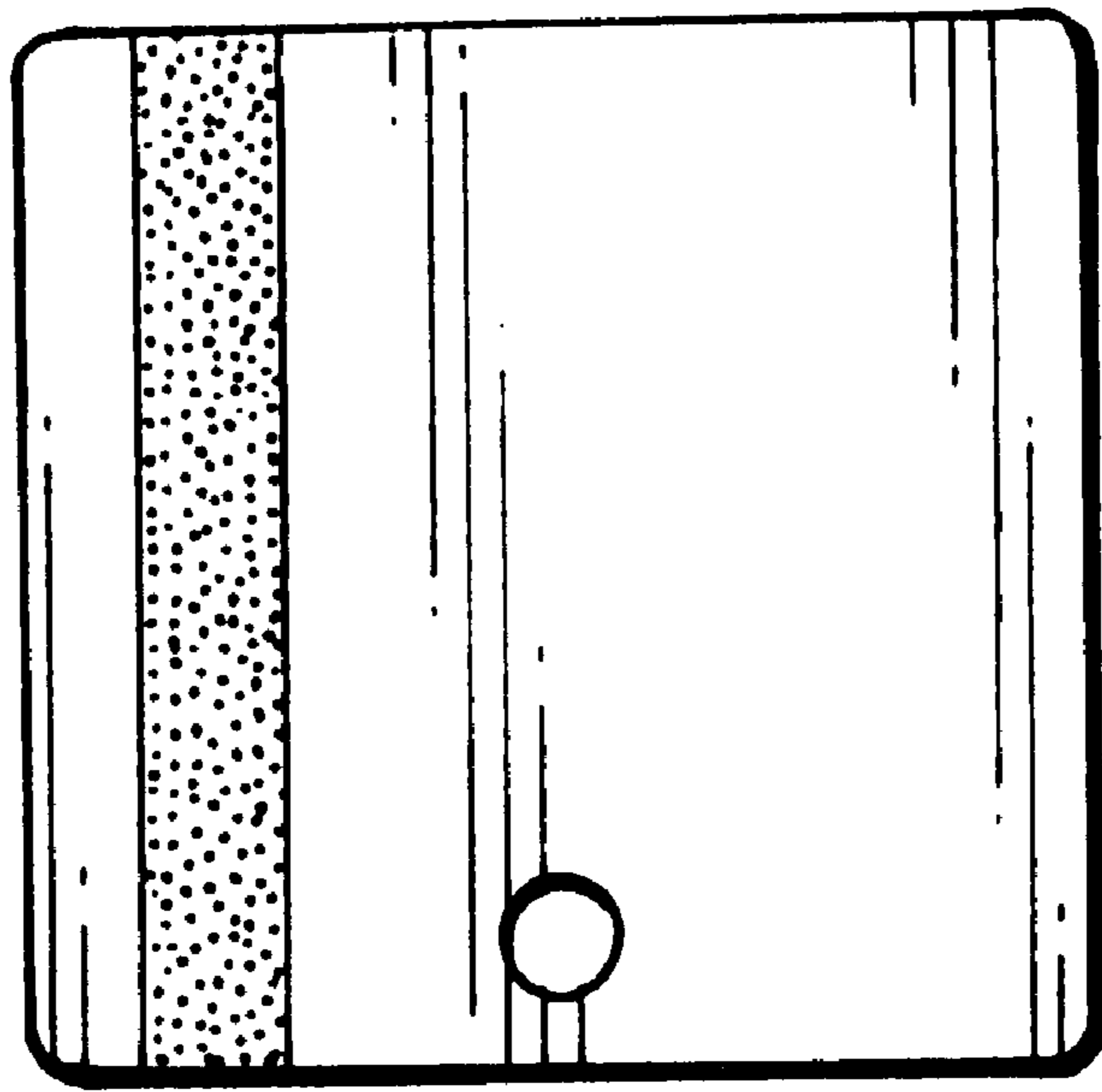

FIG. 16

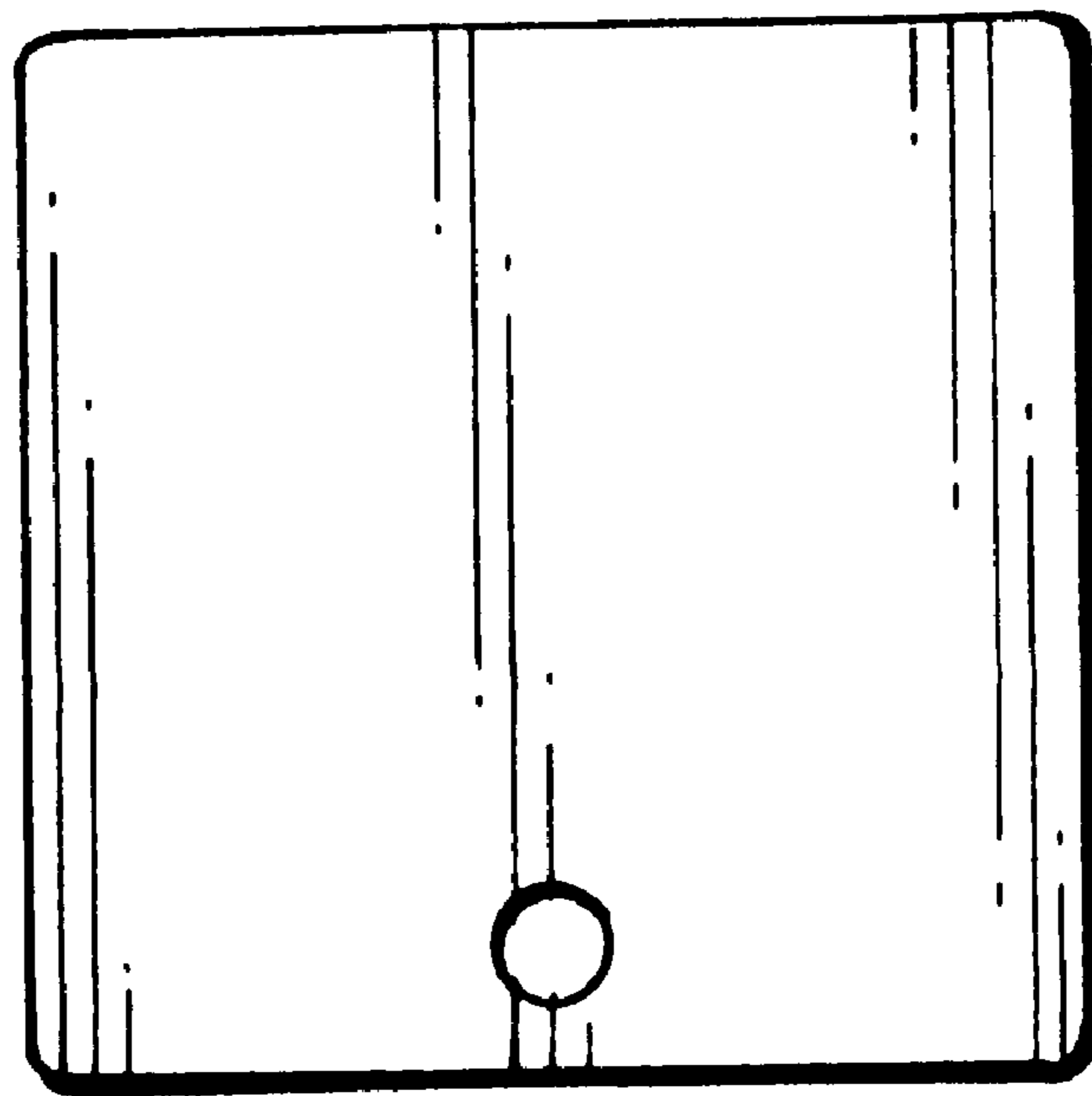

FIG. 17