



US00D462885S

(12) **United States Design Patent**  
**Hung**

(10) **Patent No.:** **US D462,885 S**

(45) **Date of Patent:** **\*\* Sep. 17, 2002**

(54) **HAND TOOL HANDLE PATTERN**

**DESCRIPTION**

(76) Inventor: **Yi-Kung Hung**, No. 29, Putou St.,  
Lochin Li, Lukang Chen, Changhua  
Hsien (TW)

(\*\*) Term: **14 Years**

(21) Appl. No.: **29/146,975**

(22) Filed: **Aug. 20, 2001**

(51) **LOC (7) Cl.** ..... **08-02**

(52) **U.S. Cl.** ..... **D8/80; D8/107**

(58) **Field of Search** ..... D8/75, 76, 77,  
D8/80, 81, 107; 81/19, 20, 21, 22, 23, 177.1,  
488, 489; 16/110.1

(56) **References Cited**

**U.S. PATENT DOCUMENTS**

D275,261	S	*	8/1984	Crowder	.....	D8/75
4,723,582	A	*	2/1988	Caspall	.....	101/31
D324,473	S	*	3/1992	Chen	.....	D8/80
D329,796	S	*	9/1992	Olson et al.	.....	D8/107
5,372,053	A	*	12/1994	Lee	.....	81/20
D376,089	S	*	12/1996	Allen	.....	D8/107
D384,564	S	*	10/1997	Bengtsson et al.	.....	D8/75
D403,223	S	*	12/1998	Jacoff	.....	D8/107
D407,000	S	*	3/1999	Jacoff	.....	D8/107
D424,396	S	*	5/2000	Jacoff	.....	D8/107
D424,903	S	*	5/2000	Hreha et al.	.....	D8/107
D432,381	S	*	10/2000	Khachatoorian	.....	D8/107

\* cited by examiner

*Primary Examiner*—Philip S. Hyder

(74) *Attorney, Agent, or Firm*—William E. Pelton, Esq.

(57) **CLAIM**

The ornamental design for a hand tool handle pattern, as shown and described.

FIG. 1 is a perspective view of a first embodiment of a hand tool with a handle having a hand tool handle pattern, showing my new design;  
 FIG. 2 is a front elevational view of FIG. 1;  
 FIG. 3 is a rear elevational view of FIG. 1;  
 FIG. 4 is a left side elevational view of FIG. 1;  
 FIG. 5 is a right side elevational view of FIG. 1;  
 FIG. 6 is a top plan view of FIG. 1;  
 FIG. 7 is a bottom plan view of FIG. 1;  
 FIG. 8 is a perspective view of a second embodiment of a hand tool with a handle having a hand tool handle pattern, showing my new design;  
 FIG. 9 is a front elevational view of FIG. 8;  
 FIG. 10 is a rear elevational view of FIG. 8;  
 FIG. 11 is a left side elevational view of FIG. 8;  
 FIG. 12 is a right side elevational view of FIG. 8;  
 FIG. 13 is a top plan view of FIG. 8;  
 FIG. 14 is a bottom plan view of FIG. 8;  
 FIG. 15 is a perspective view of a third embodiment of a hand tool with a handle having a hand tool handle pattern, showing my new design;  
 FIG. 16 is a front elevational view of FIG. 15;  
 FIG. 17 is a rear elevational view of FIG. 15;  
 FIG. 18 is a left side elevational view of FIG. 15;  
 FIG. 19 is a right side elevational view of FIG. 15;  
 FIG. 20 is a top plan view of FIG. 15;  
 FIG. 21 is a bottom plan view of FIG. 15;  
 FIG. 22 is a perspective view of a fourth embodiment of a hand tool with a handle a hand tool handle having pattern, showing my new design;  
 FIG. 23 is a front elevational view of FIG. 22;  
 FIG. 24 is a rear elevational view of FIG. 22;  
 FIG. 25 is a left side elevational view of FIG. 22;  
 FIG. 26 is a right side elevational view of FIG. 22;  
 FIG. 27 is a top plan view of FIG. 22; and,  
 FIG. 28 is a bottom plan view of FIG. 22.  
 Wherein the broken lines are shown for illustrative purposes only and form no part of the claimed design.

**1 Claim, 20 Drawing Sheets**

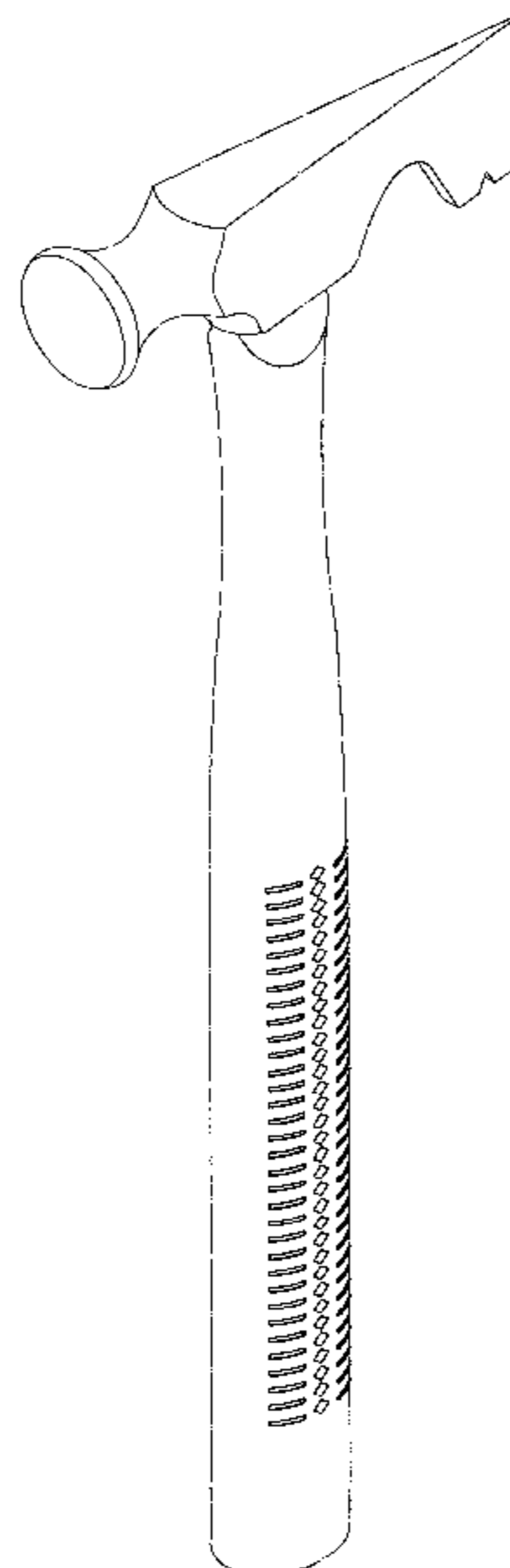

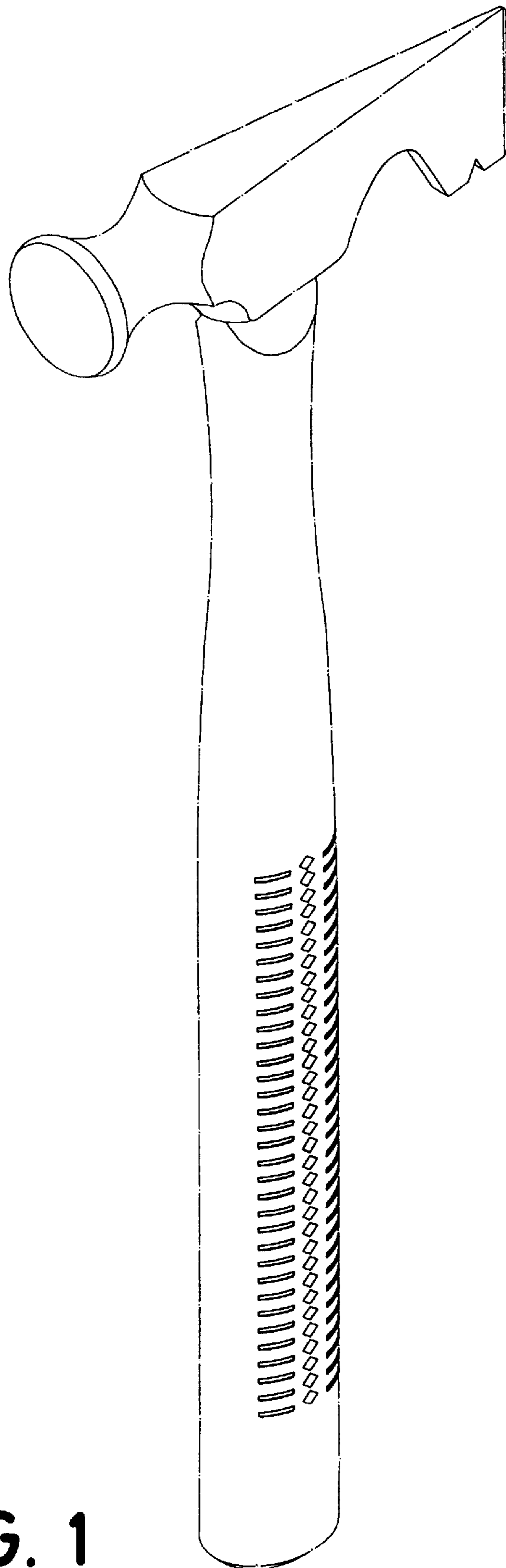

FIG. 1

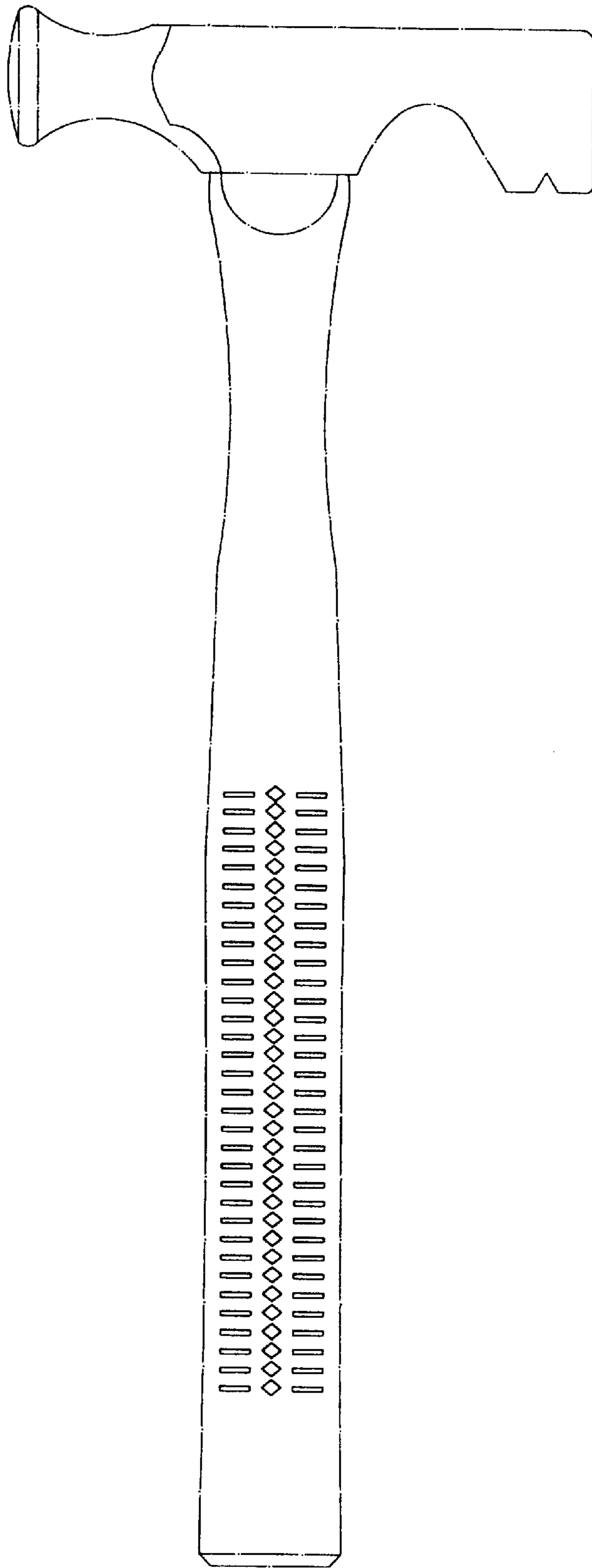
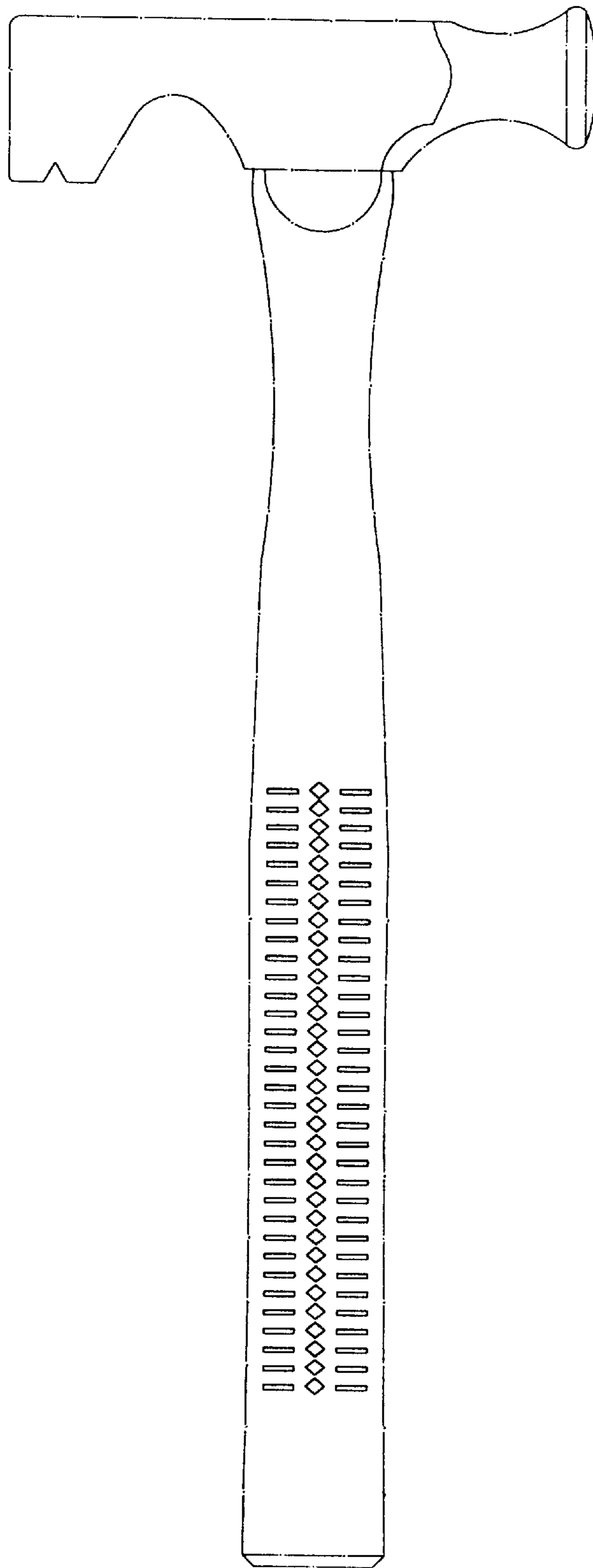

FIG. 2



**FIG. 3**

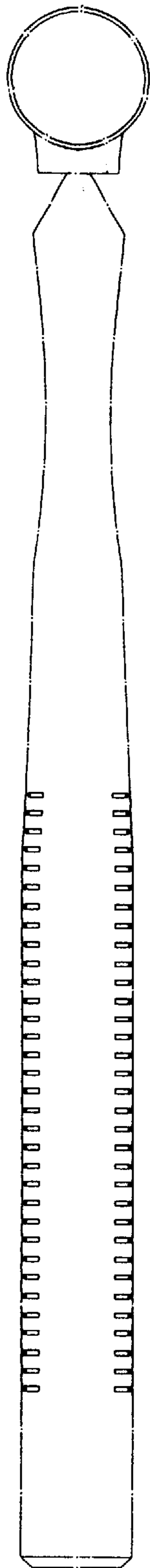

FIG. 4

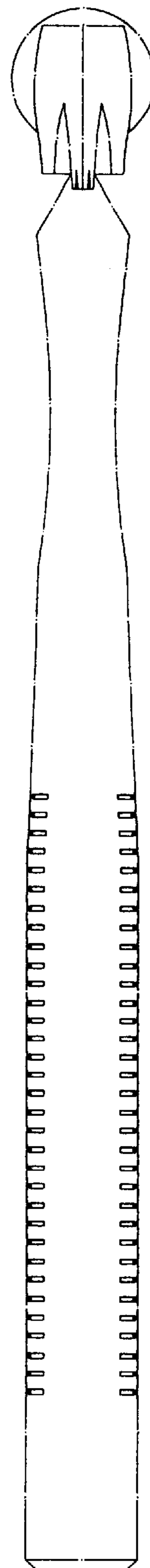
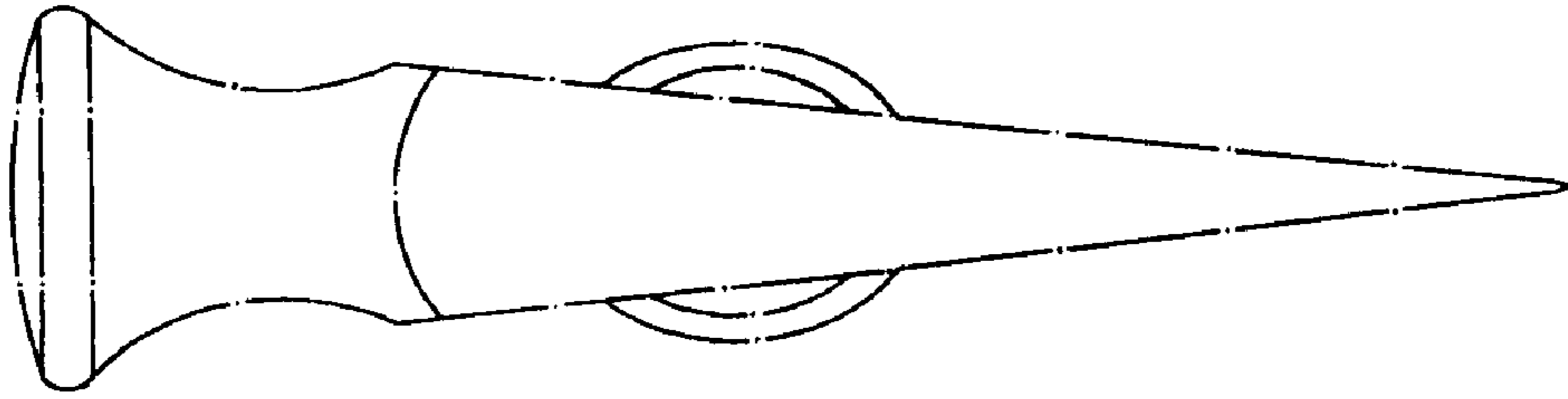
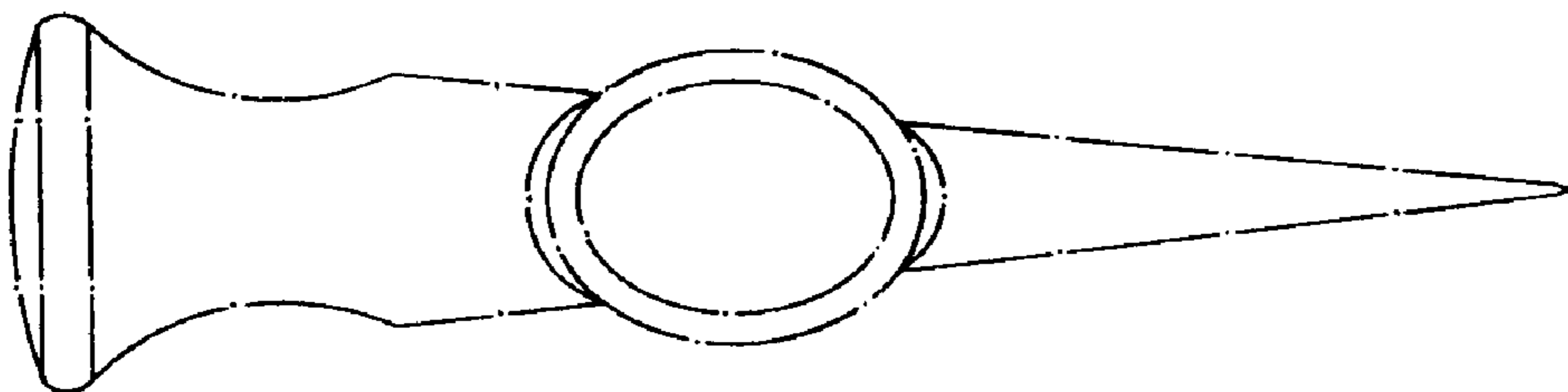

FIG. 5



**FIG. 6**



**FIG. 7**

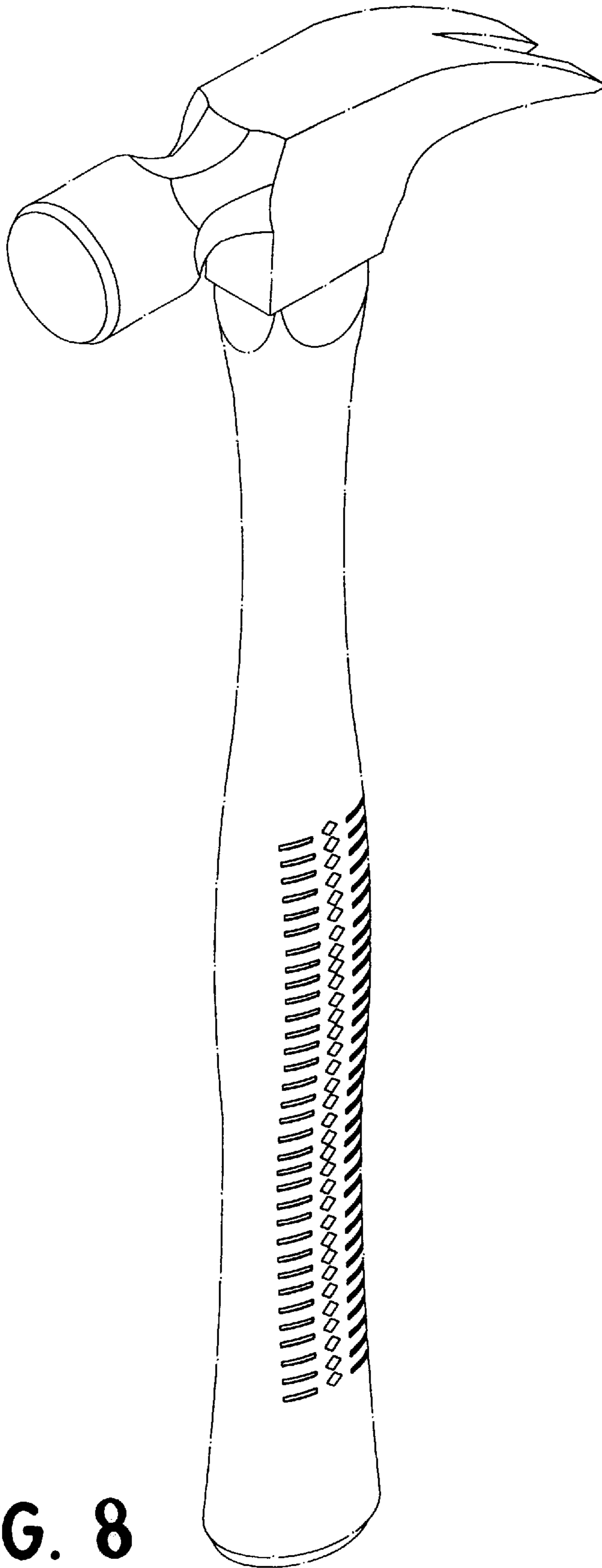

FIG. 8

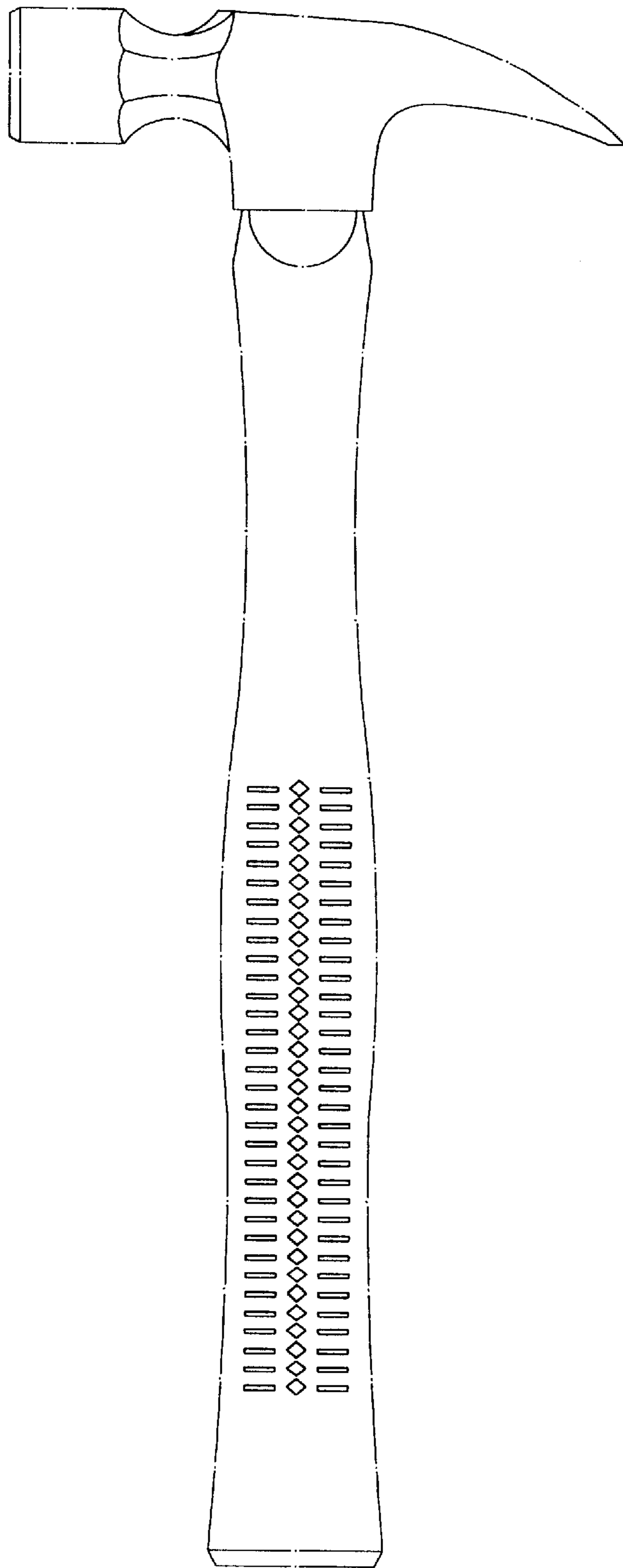

FIG. 9



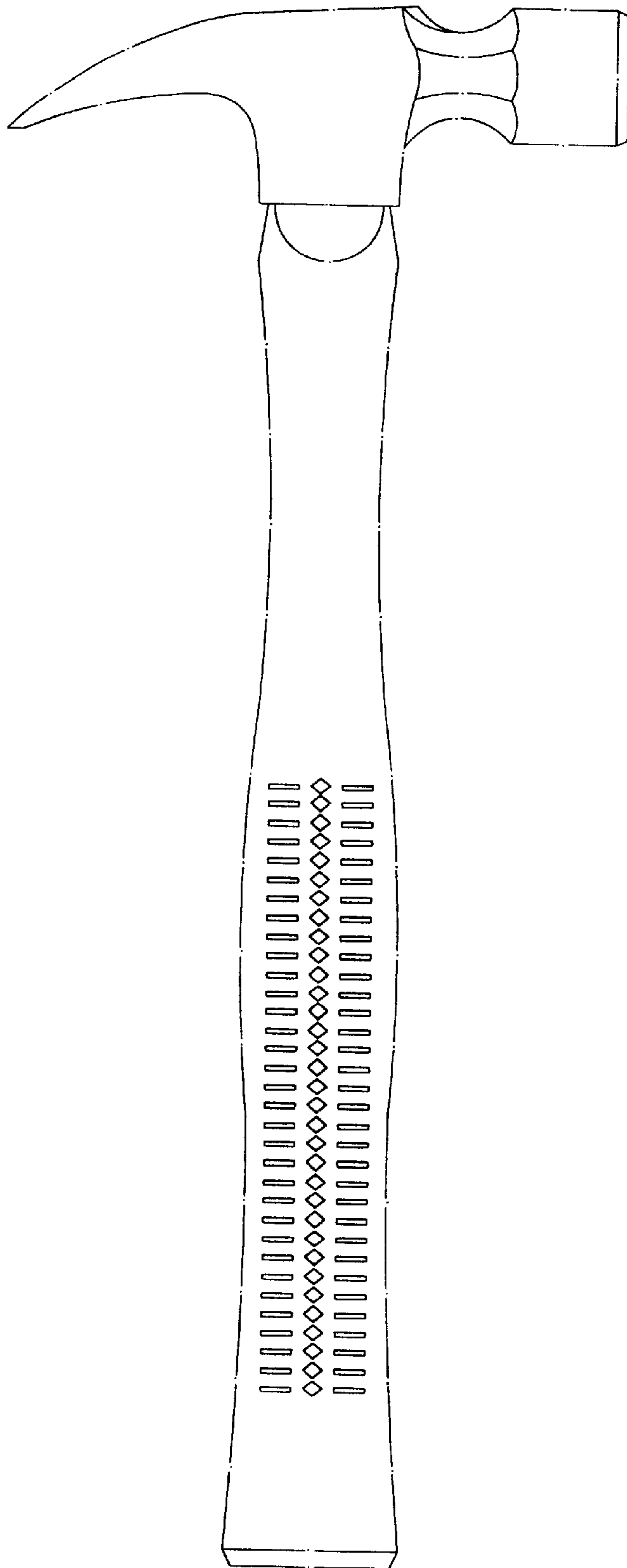

FIG. 10

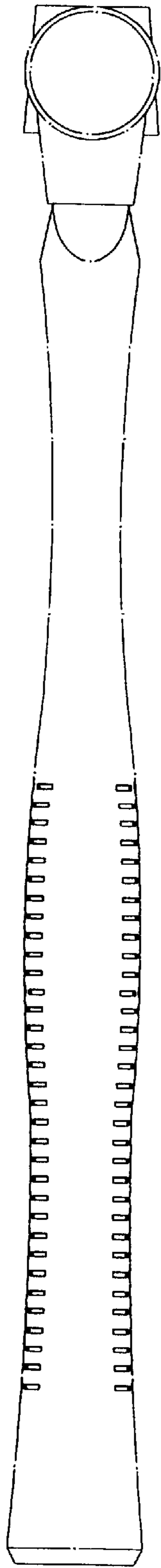

FIG. 11

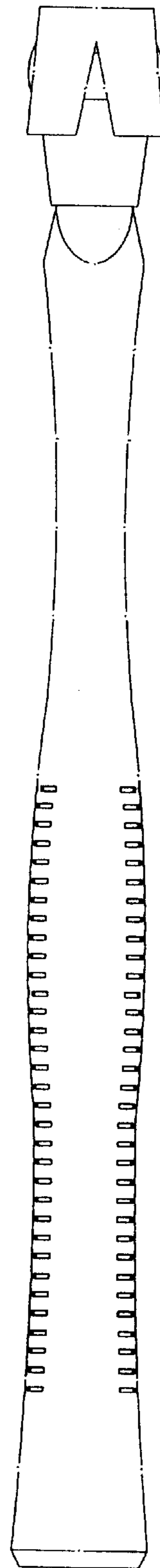
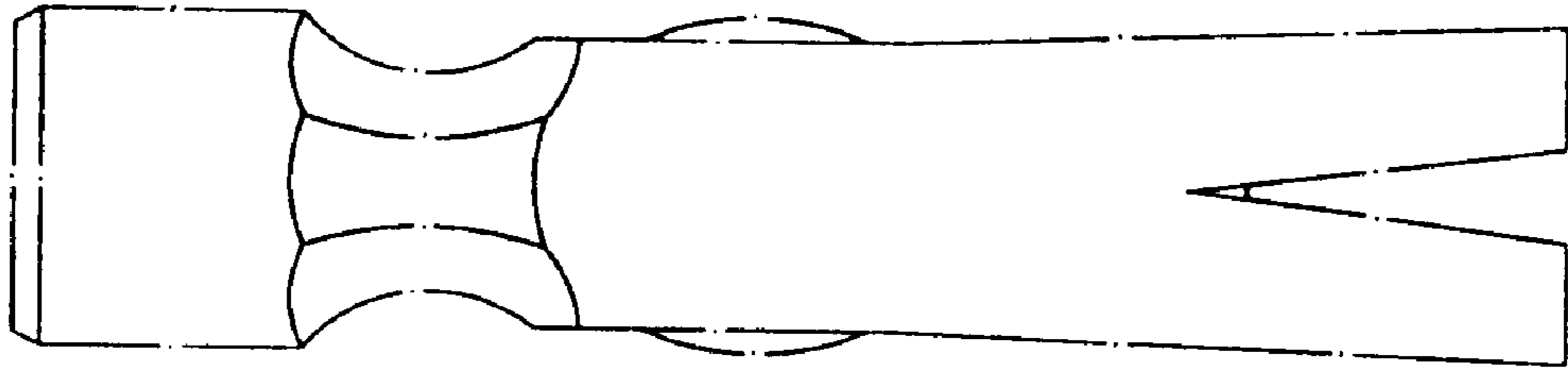
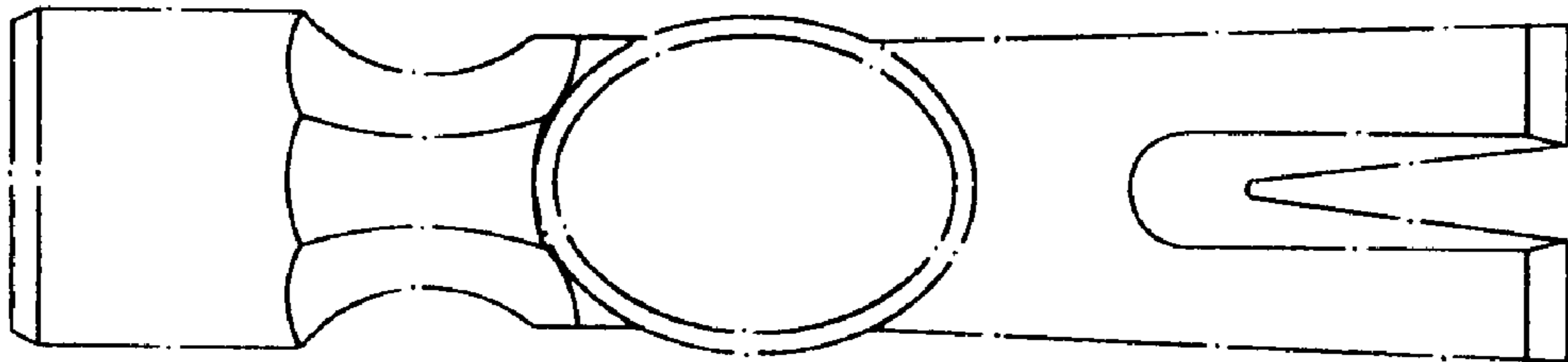

FIG. 12



**FIG. 13**



**FIG. 14**

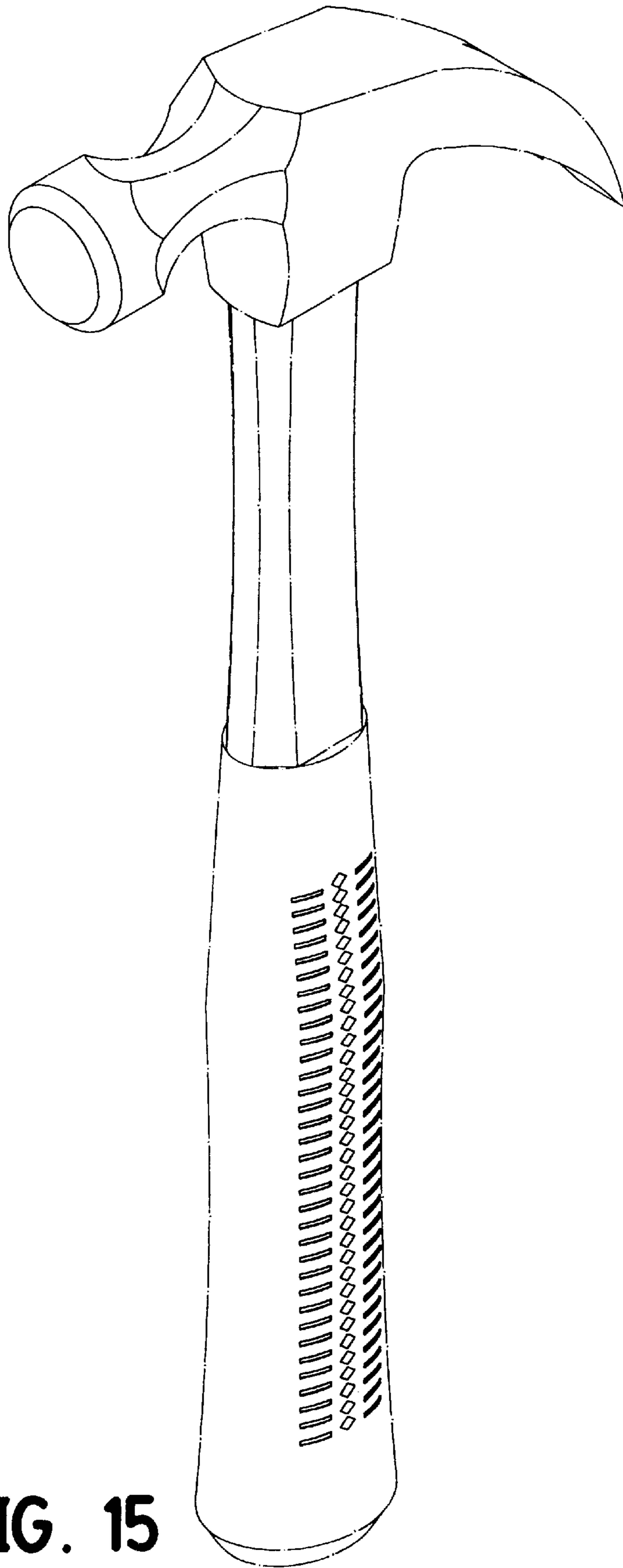

**FIG. 15**

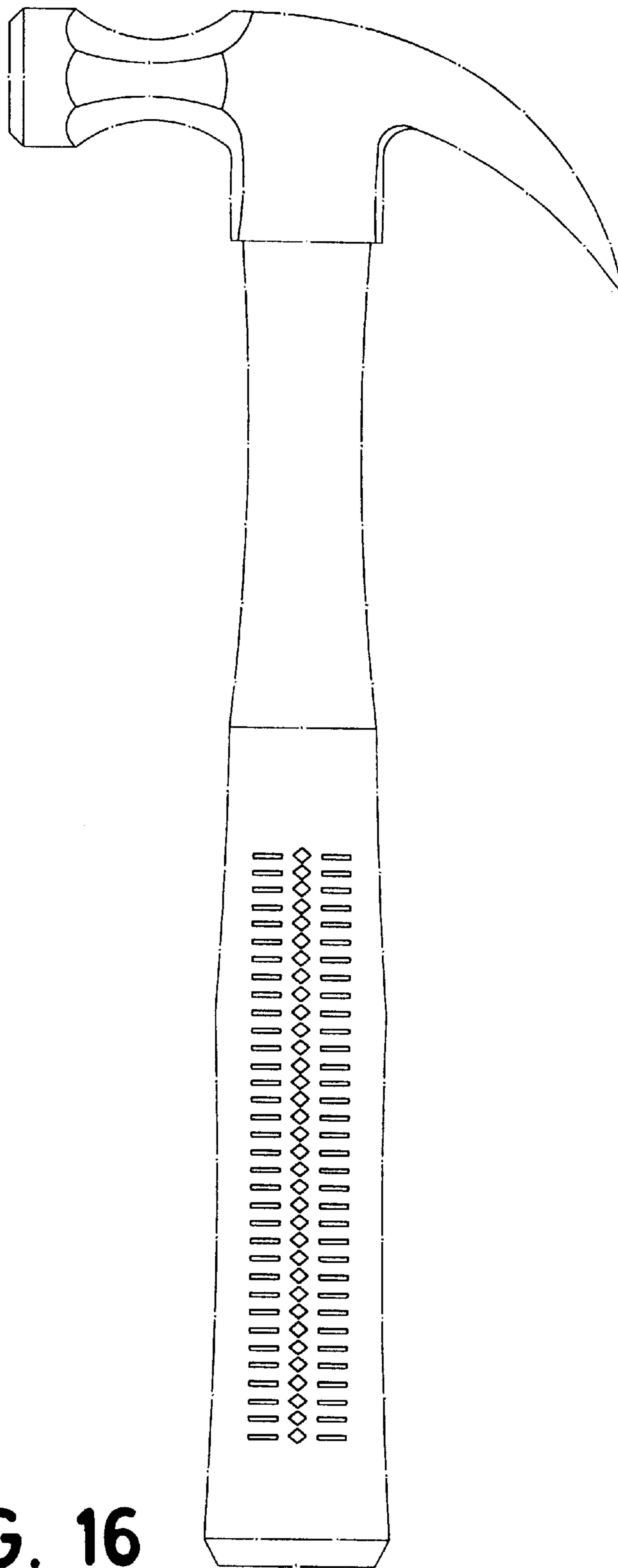

**FIG. 16**

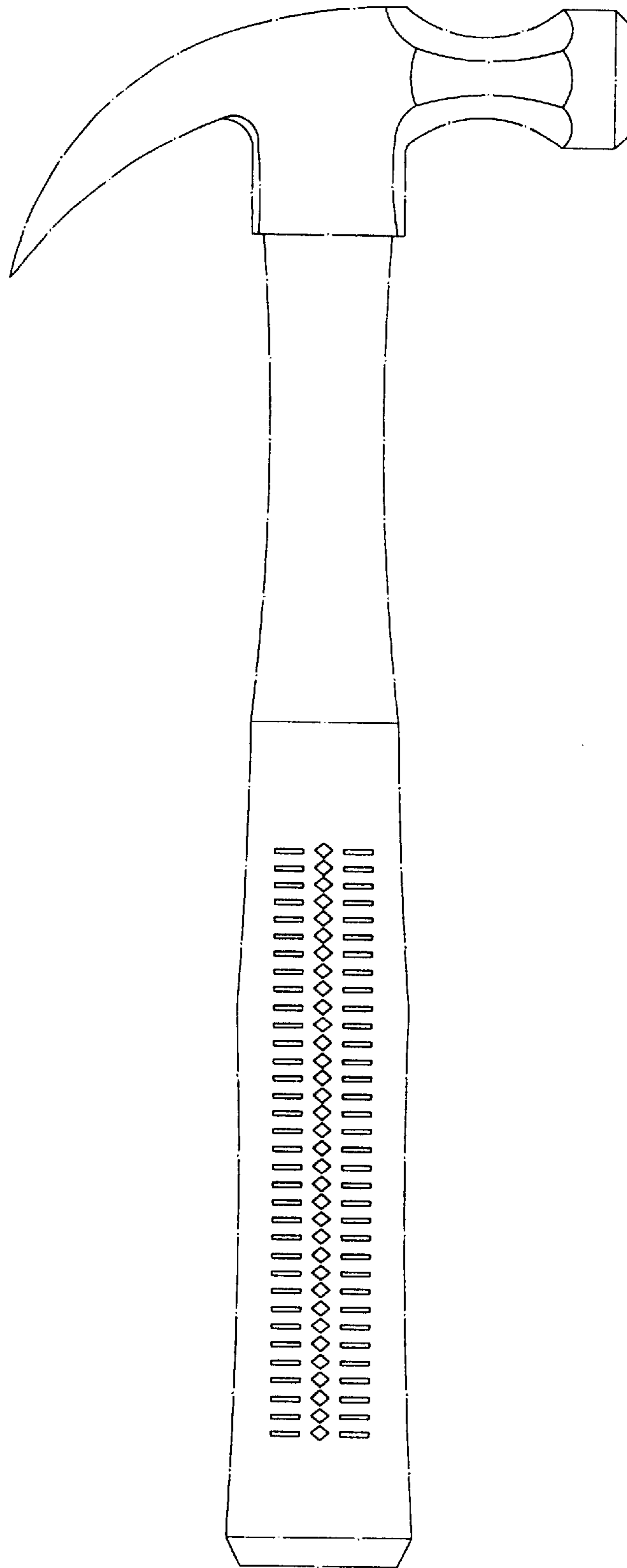

**FIG. 17**

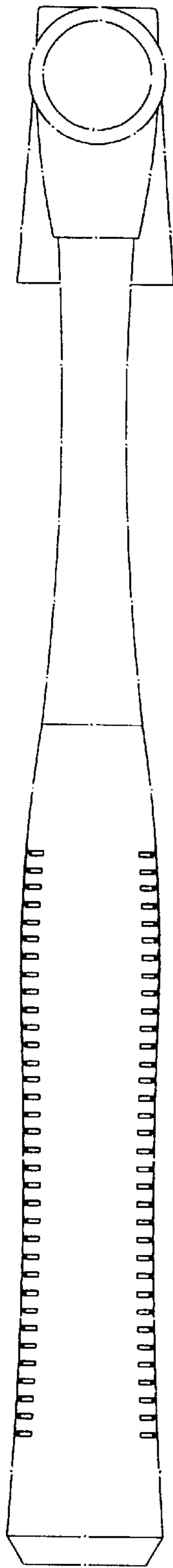

**FIG. 18**

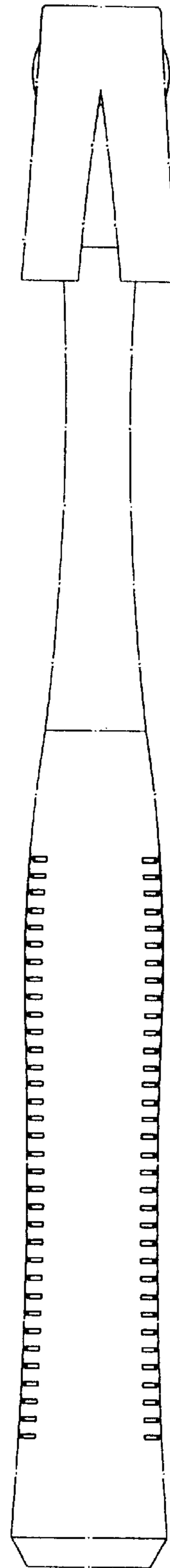

**FIG. 19**

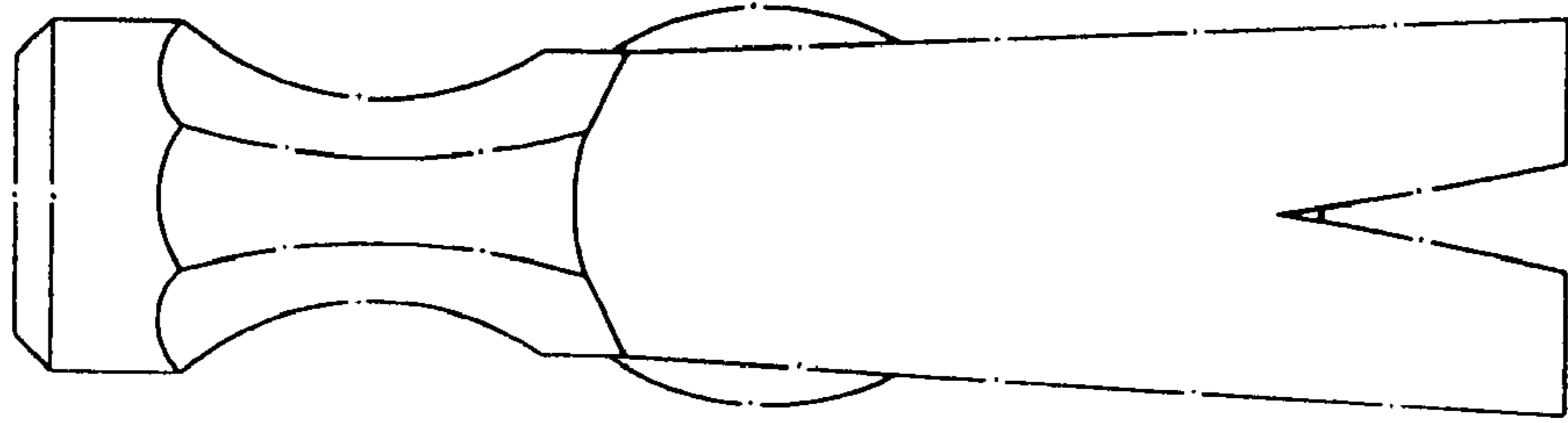

**FIG. 20.**

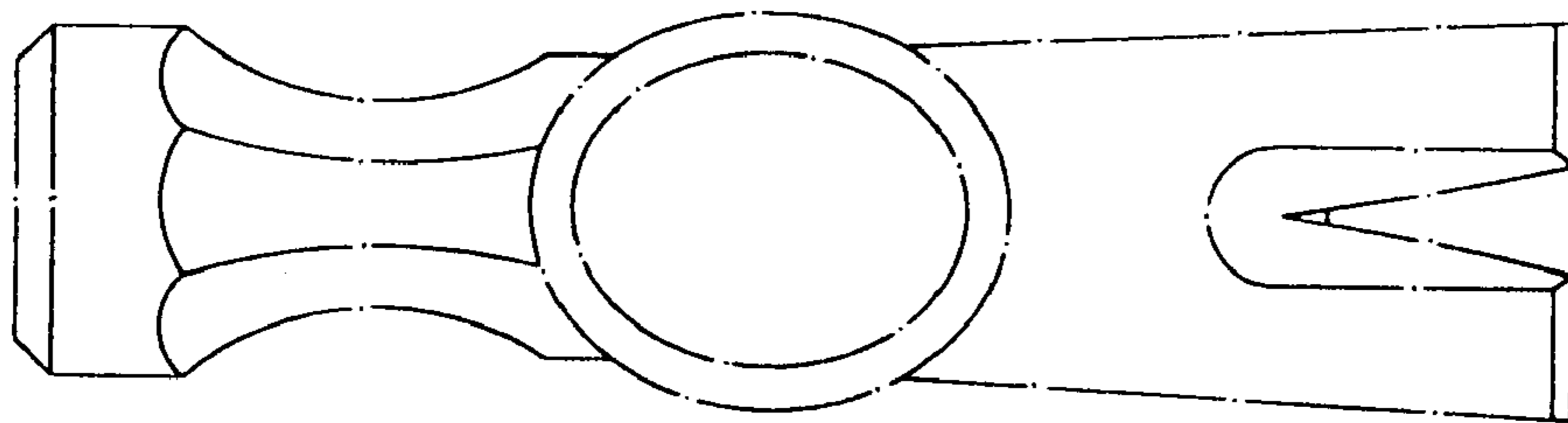

**FIG. 21**



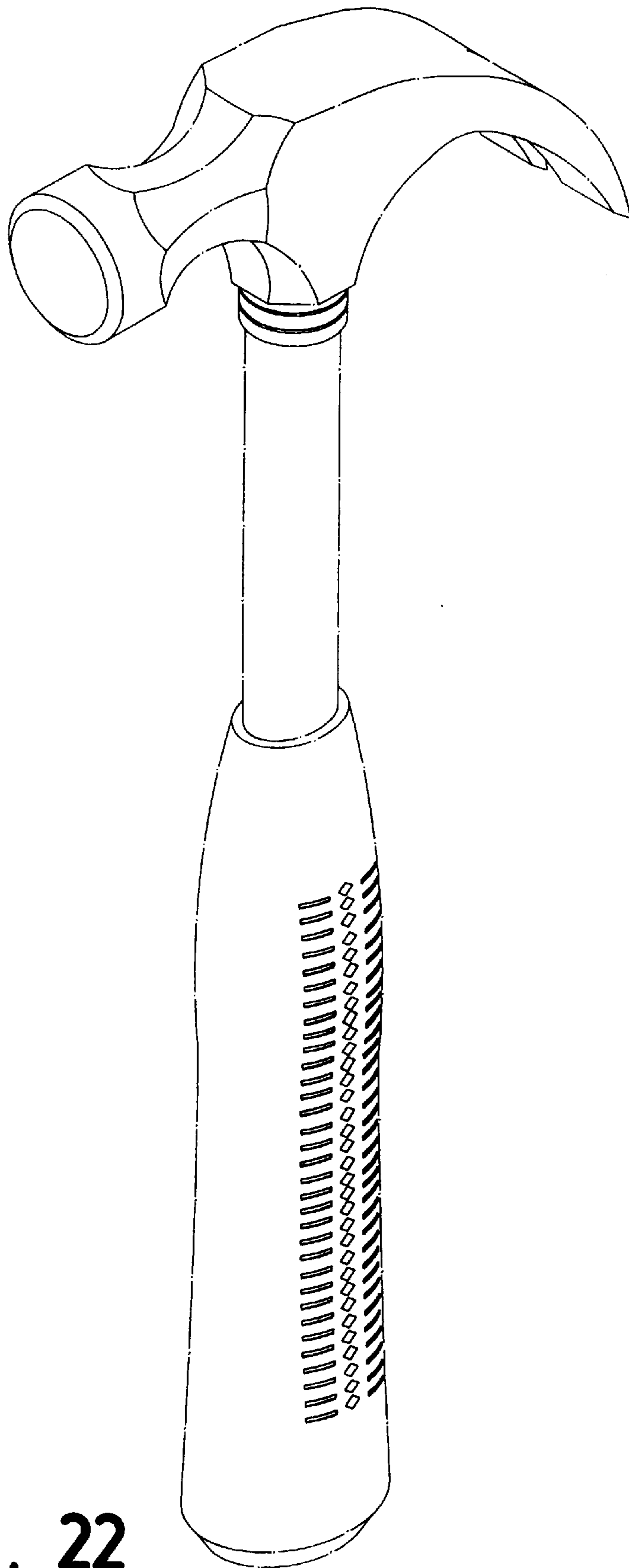
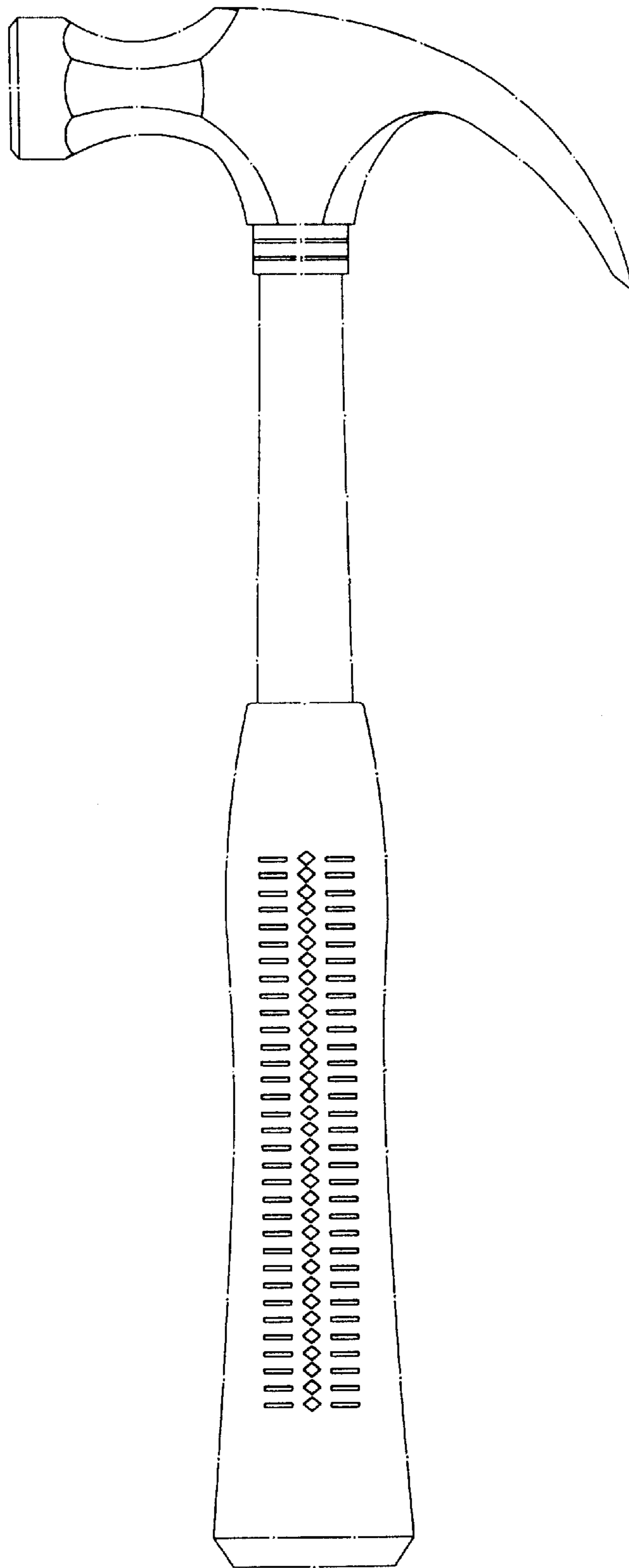

FIG. 22



**FIG. 23**

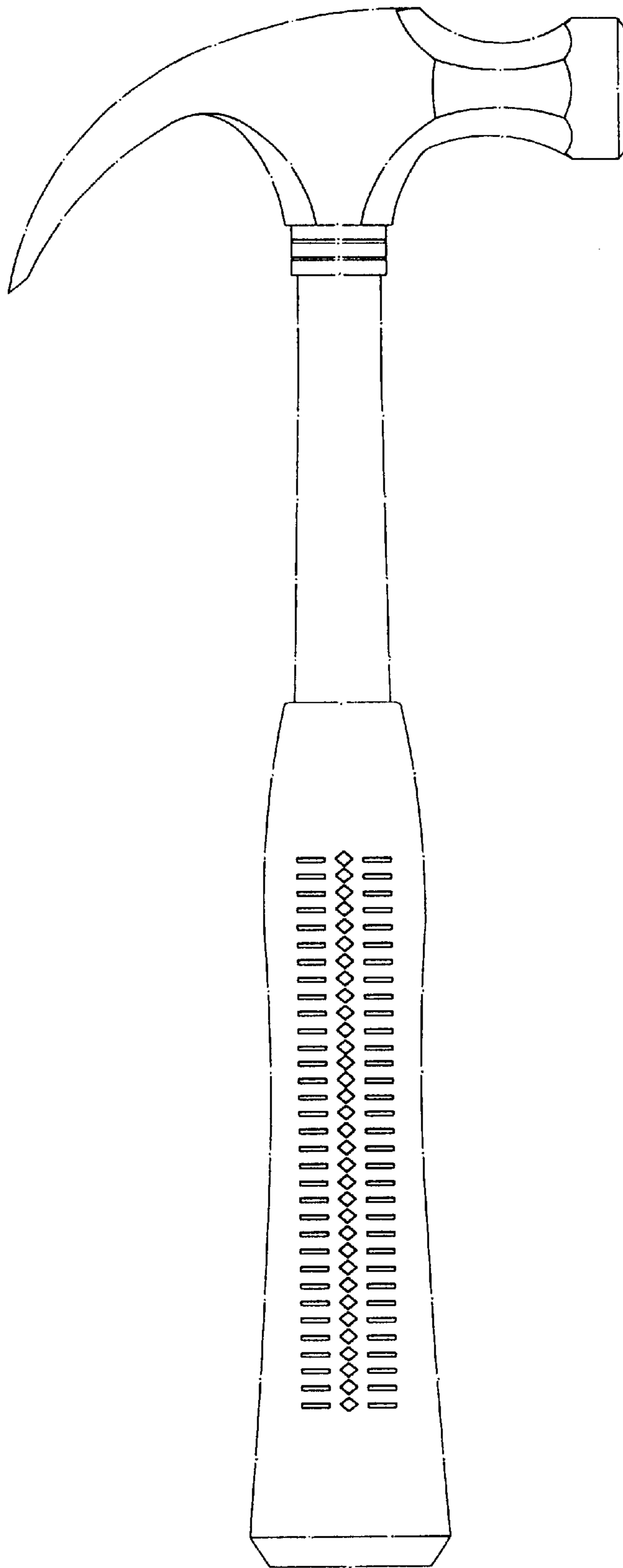

FIG. 24

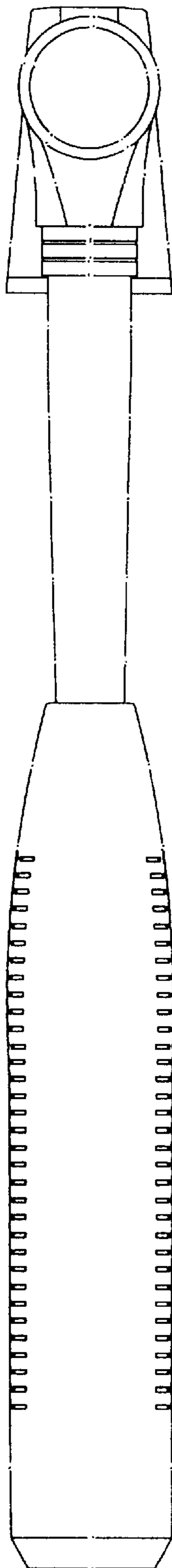

FIG. 25

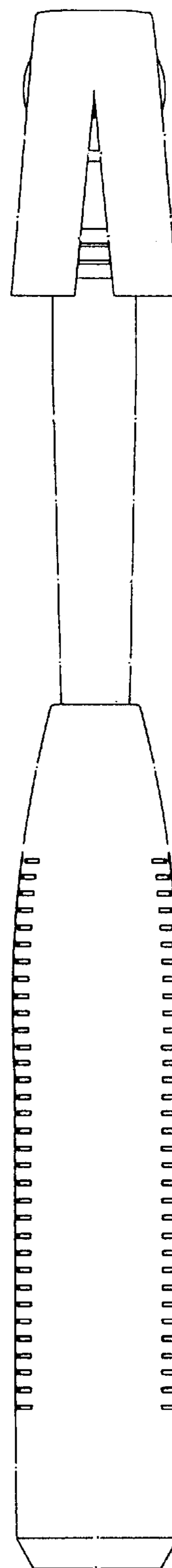
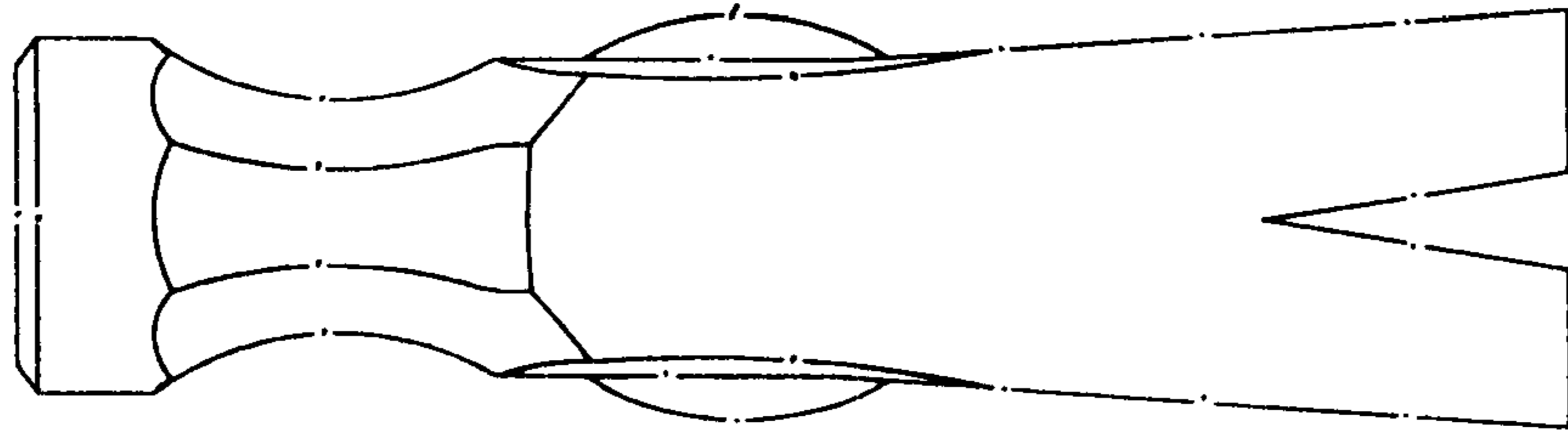
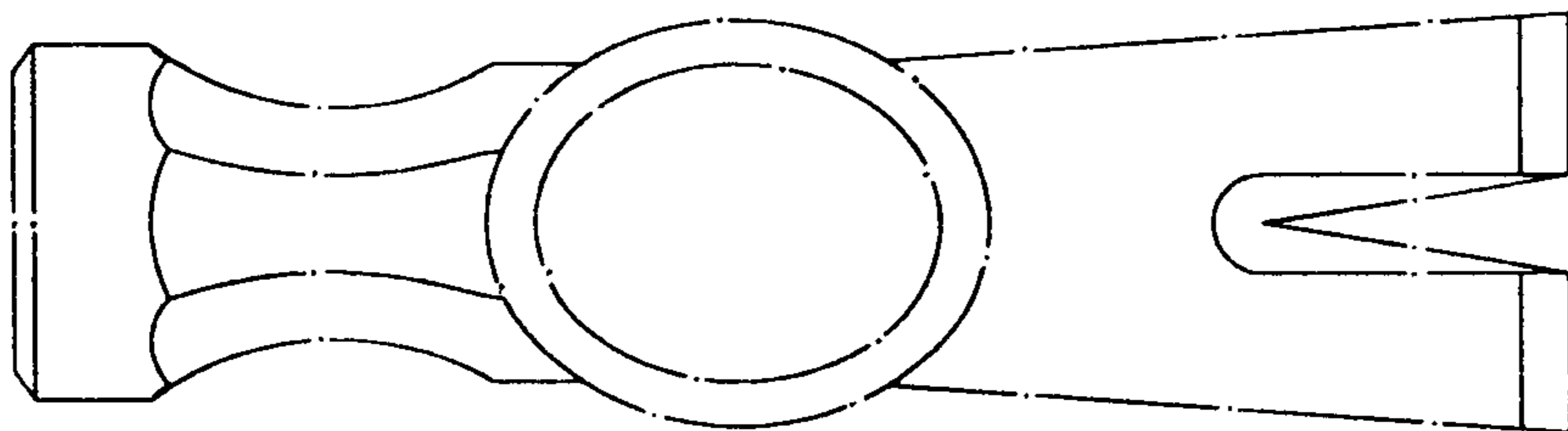

FIG. 26



**FIG. 27**



**FIG. 28**