

US00D462815S

(12) **United States Design Patent**
Roberts et al.

(10) **Patent No.:** **US D462,815 S**
(45) **Date of Patent:** **** Sep. 10, 2002**

(54) **VACUUM CLEANER UPPER PORTION**
(75) Inventors: **Kenneth L. Roberts**, Rockford, MI
(US); **Kevin T. Downey**, Grand Rapids,
MI (US)

(73) Assignee: **Bissell Homecare, Inc.**, Grand Rapids,
MI (US)

(**) Term: **14 Years**

(21) Appl. No.: **29/152,217**

(22) Filed: **Oct. 30, 2001**

(51) **LOC (7) Cl.** **15-05**

(52) **U.S. Cl.** **D32/31**

(58) **Field of Search** D32/21-22, 31,
D32/34; 15/320-321, 347, 350-353, 361,
410-411, 377, 323, DIG. 10; 174/46; 285/7;
439/191

(56) **References Cited**

U.S. PATENT DOCUMENTS

- D358,236 S * 5/1995 Kopco et al. D32/22
- D371,652 S 7/1996 Umbach
- D403,480 S 12/1998 Diebel

- D418,265 S * 12/1999 Farone D32/22
- 6,003,196 A 12/1999 Wright et al.
- 6,026,540 A * 2/2000 Wright et al. 15/347
- D429,854 S * 8/2000 Hohulin et al. D32/22
- D434,884 S * 12/2000 Hohulin et al. D32/22
- D452,758 S * 1/2002 Yokoyama et al. D32/22

* cited by examiner

Primary Examiner—Ruth McInroy

(74) *Attorney, Agent, or Firm*—McGarry Bair LLP

(57) **CLAIM**

The ornamental design for a vacuum cleaner upper portion,
as shown and described.

DESCRIPTION

FIG. 1 is a perspective view of a vacuum cleaner upper portion showing our new design;
FIG. 2 is a front view thereof;
FIG. 3 is a rear view thereof;
FIG. 4 is a left side view thereof;
FIG. 5 is a right side view thereof;
FIG. 6 is a top view thereof; and,
FIG. 7 is a bottom view thereof.

1 Claim, 6 Drawing Sheets

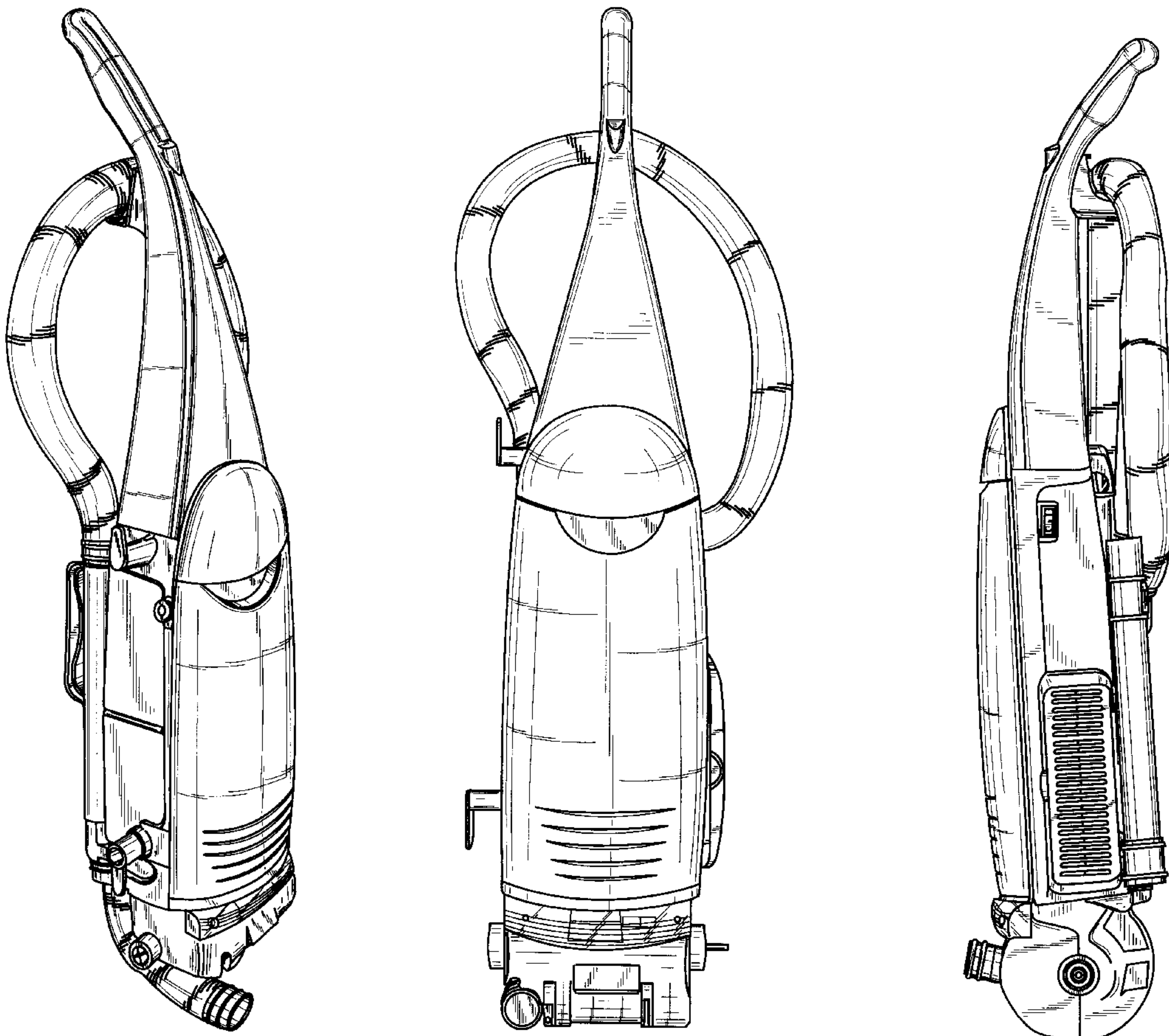

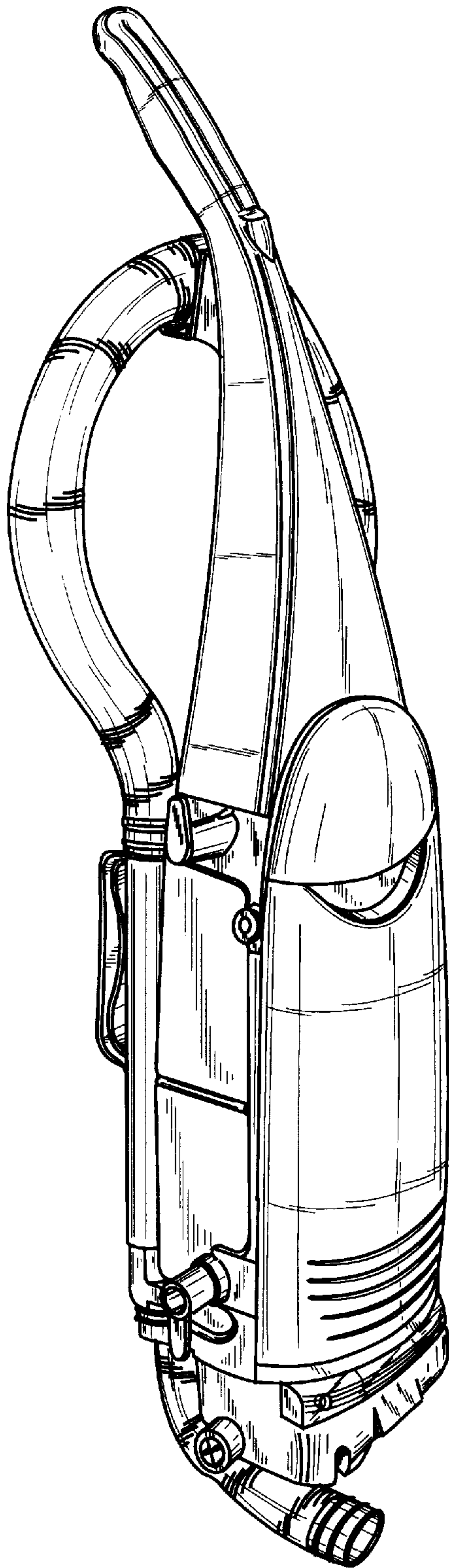

Fig. 1

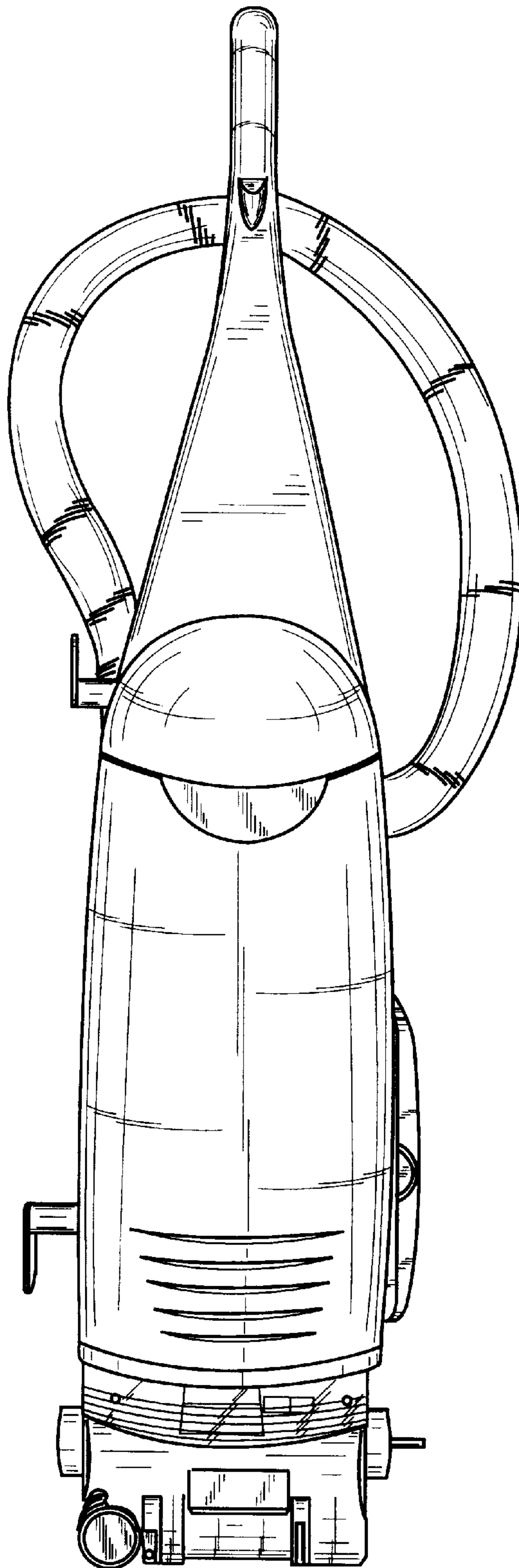

Fig. 2

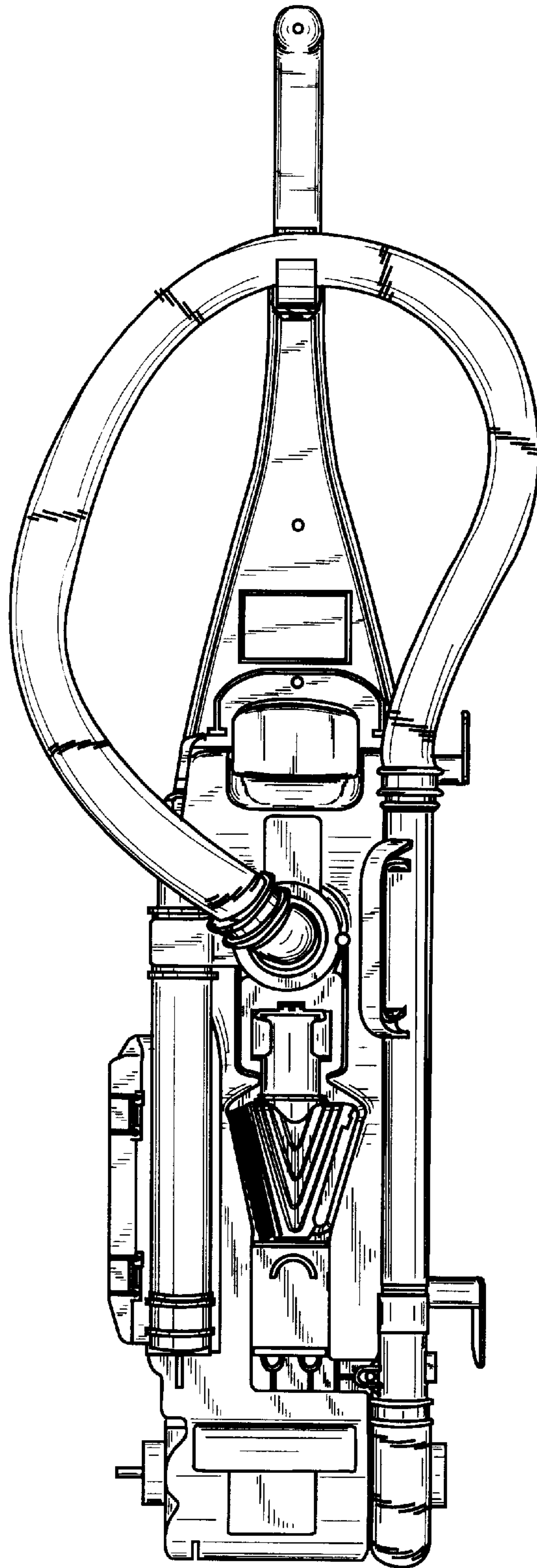

Fig. 3

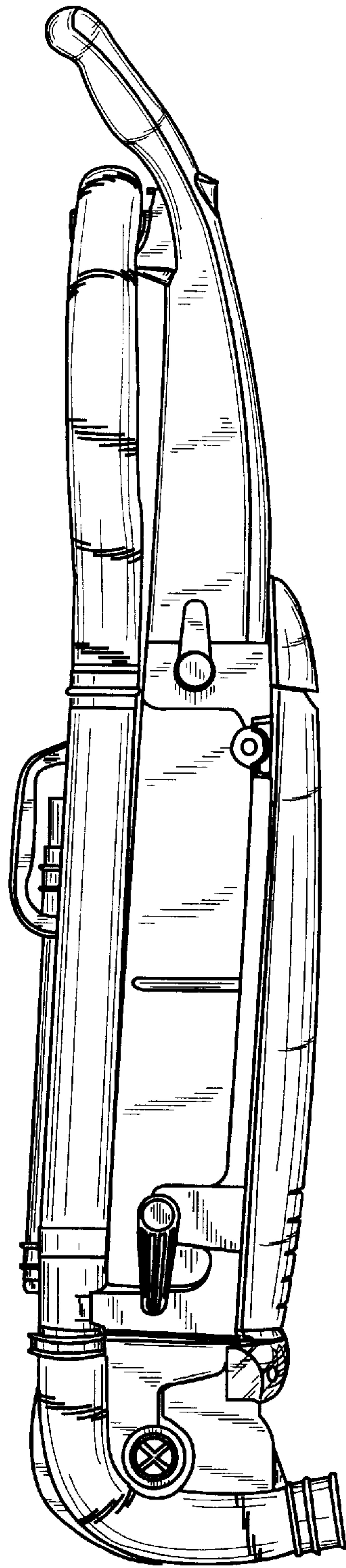

Fig. 4

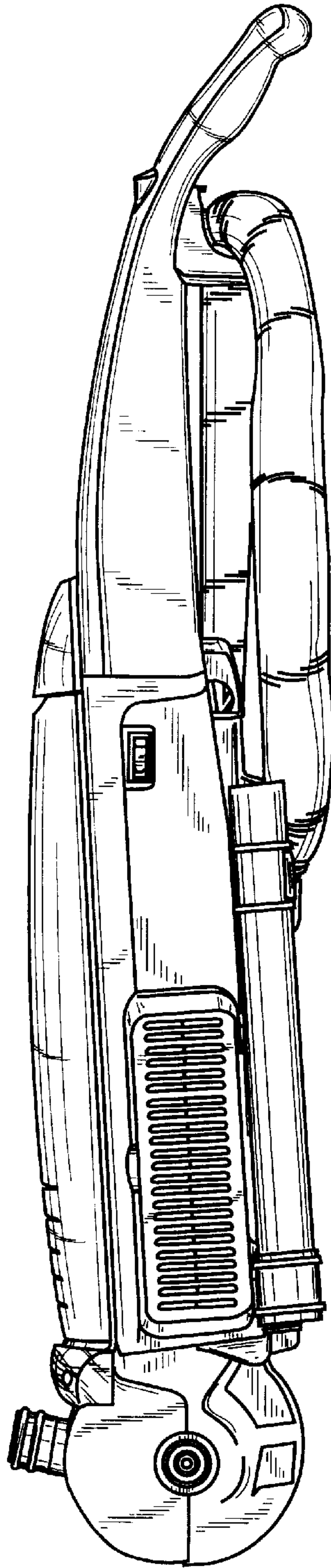

Fig. 5

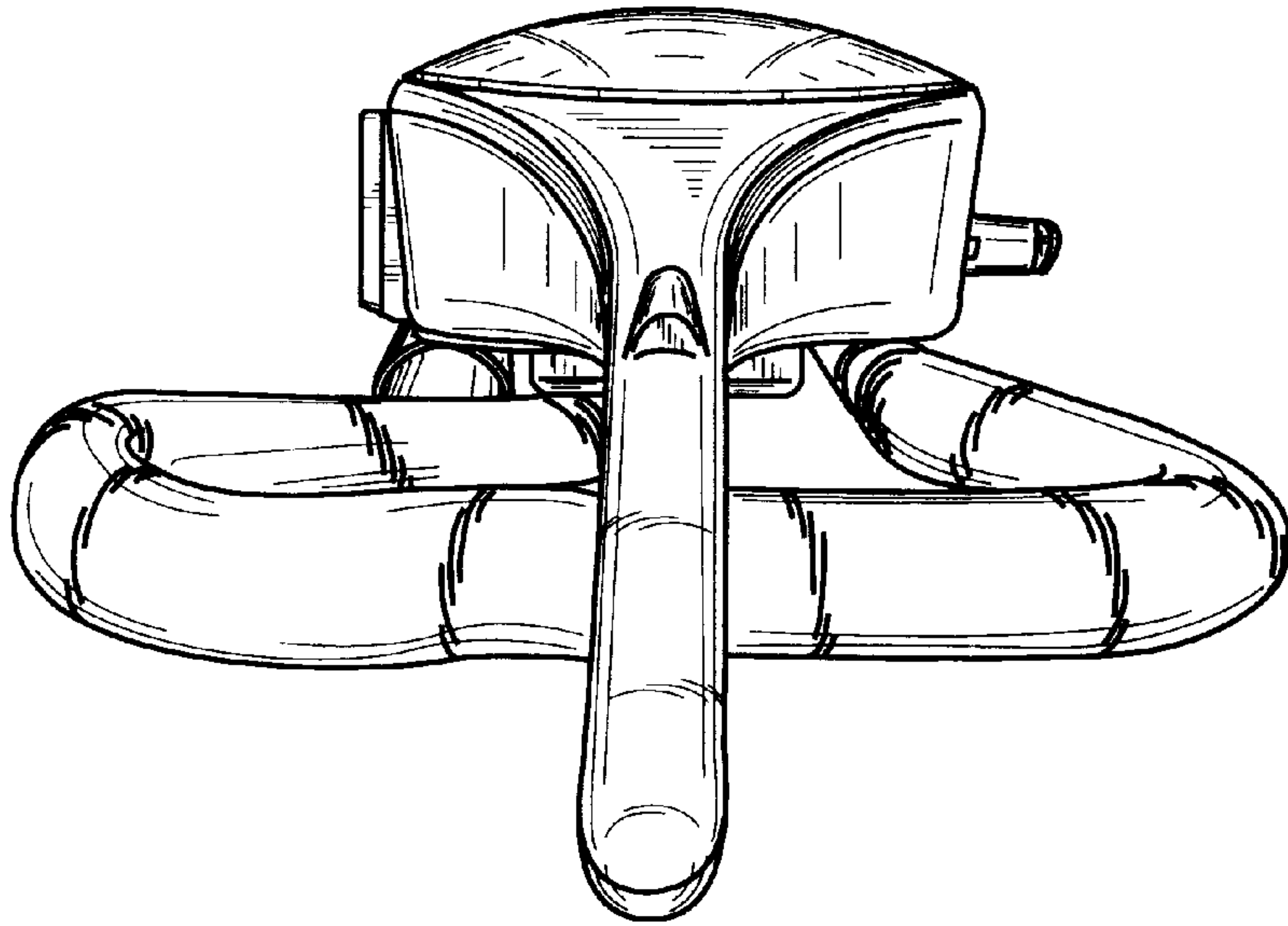

Fig. 6

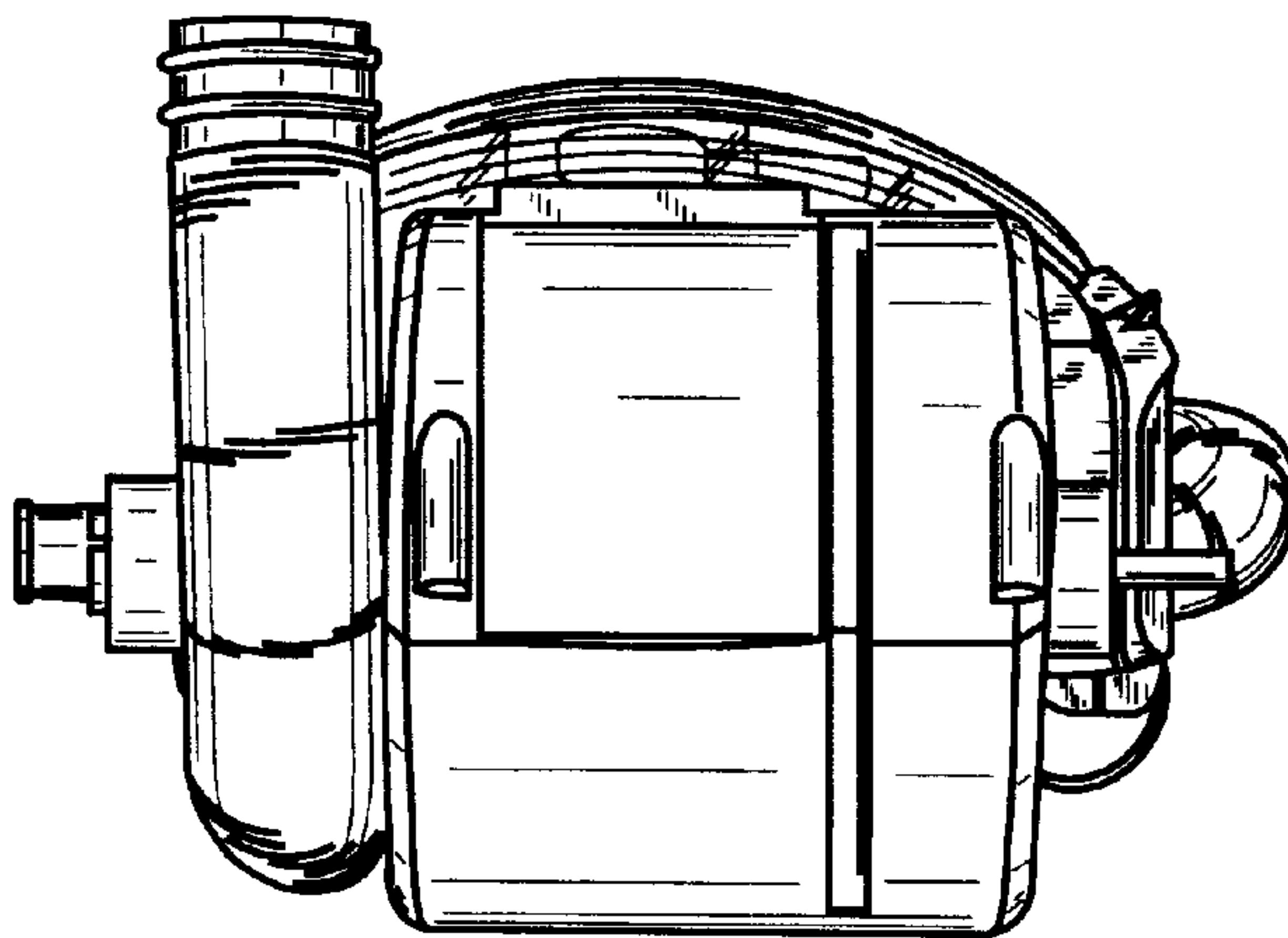

Fig. 7