



US00D462804S

(12) **United States Design Patent**
Maruyama

(10) **Patent No.:** **US D462,804 S**

(45) **Date of Patent:** **** Sep. 10, 2002**

(54) **LIGHTER**

D452,584 S * 12/2001 Chen D27/157

(75) Inventor: **Susume Maruyama**, Tokyo (JP)

* cited by examiner

(73) Assignee: **Windmill Kabushiki Kaisha**, Tokyo (JP)

Primary Examiner—Jennifer Rivard

(74) *Attorney, Agent, or Firm*—Rader, Fishman & Grauer PLLC

(**) Term: **14 Years**

(57) **CLAIM**

(21) Appl. No.: **29/156,536**

The ornamental design for lighter, as shown and described.

(22) Filed: **Mar. 4, 2002**

DESCRIPTION

(51) **LOC (7) Cl.** **27-05**

(52) **U.S. Cl.** **D27/155**

(58) **Field of Search** D27/141, 142,
D27/143, 152–155, 157, 159, 160; 431/129,
130, 132, 143–144, 151, 254–256, 253,
267, 273–274, 277

FIG. 1 is a perspective view of the lighter showing my new design;

FIG. 2 is a front elevational view thereof;

FIG. 3 is a top plan view thereof;

FIG. 4 is a left side elevational view thereof;

FIG. 5 is a right side elevational view thereof;

FIG. 6 is a bottom plan view thereof; and,

FIG. 7 is a perspective view showing status on use thereof.

The broken line environmental showing is for illustrative purposes only and forms no part of the claimed design.

(56) **References Cited**

U.S. PATENT DOCUMENTS

D291,371 S * 8/1987 Stutzer D27/141

D312,707 S * 12/1990 Demory D26/141

1 Claim, 4 Drawing Sheets

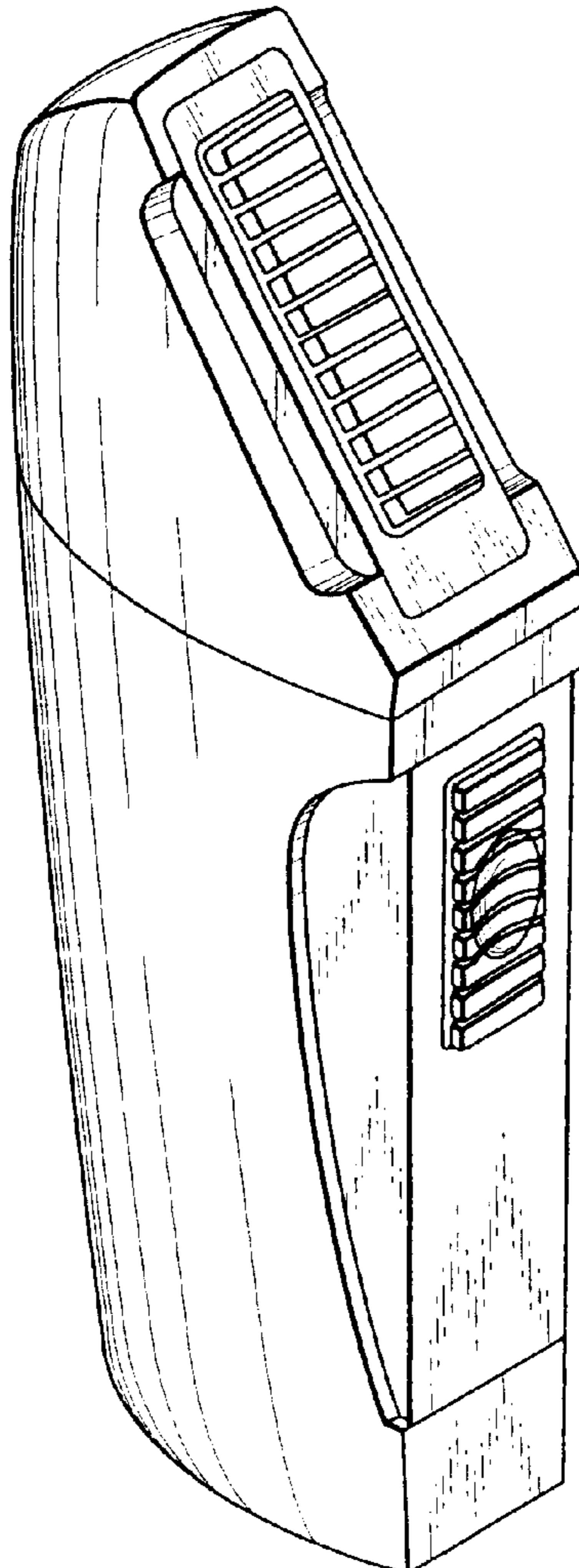

Fig. 1

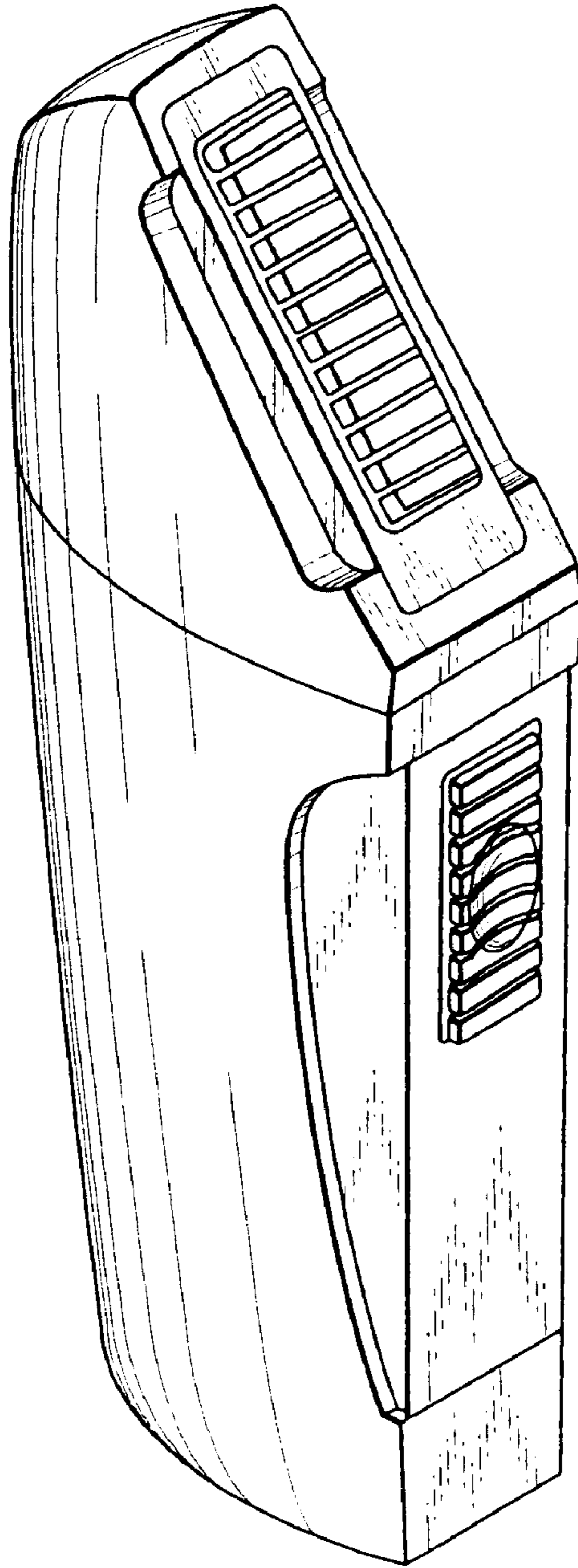

Fig. 2

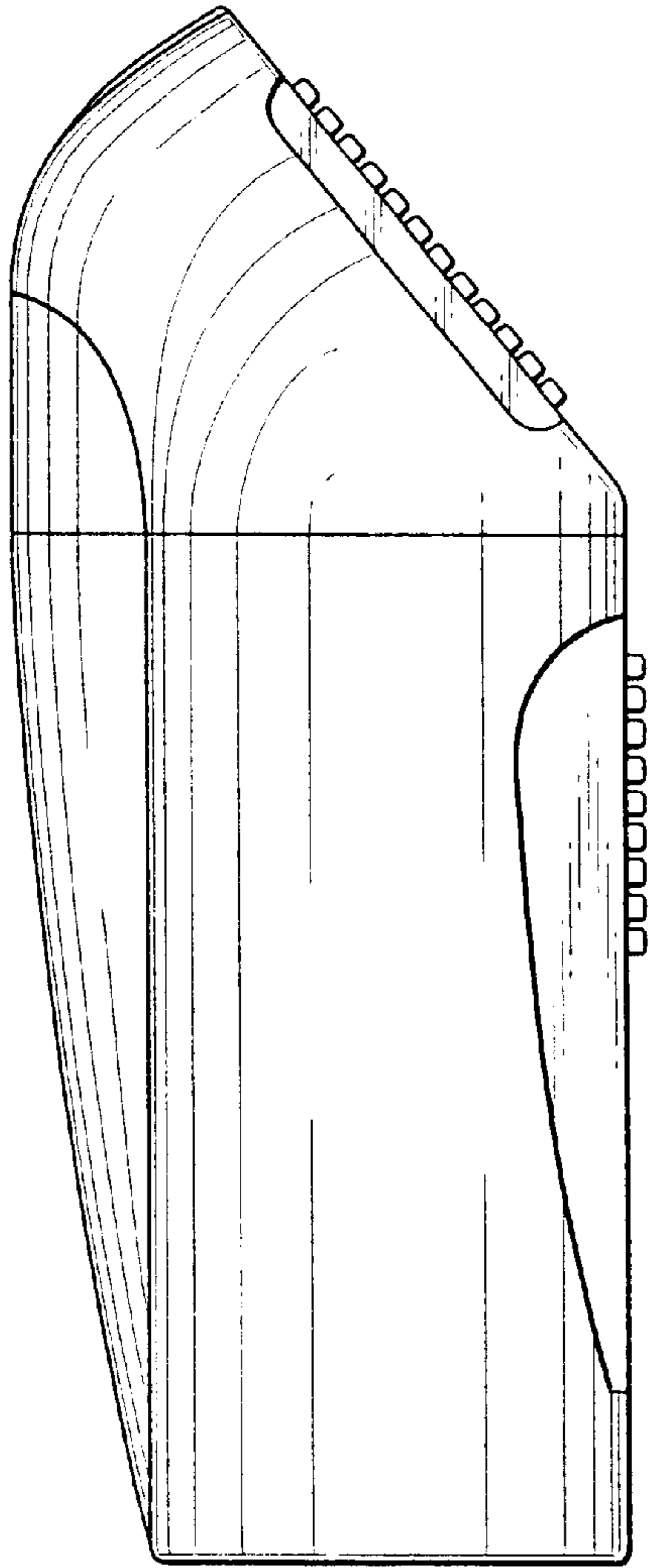

Fig. 3

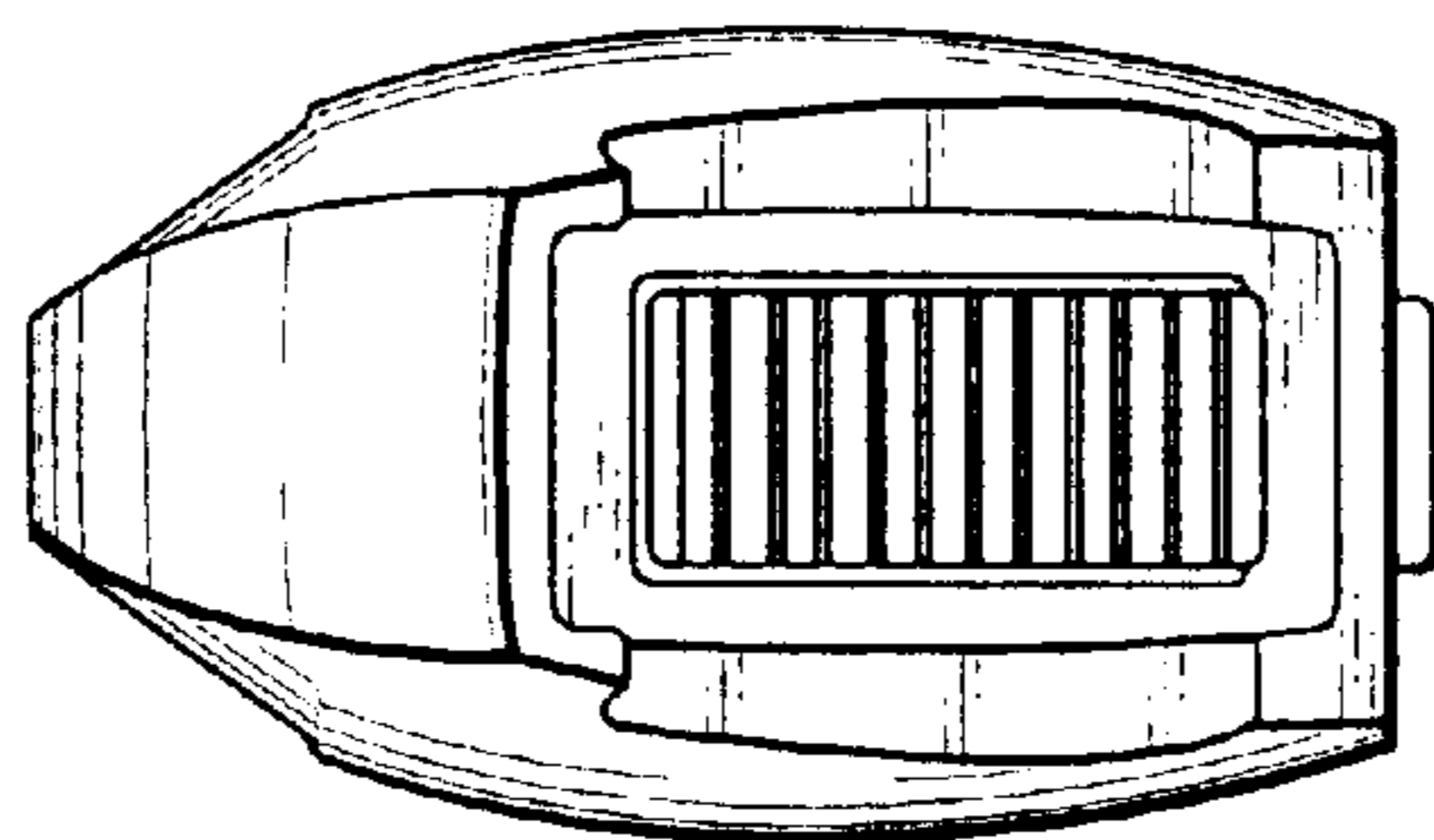

Fig. 4

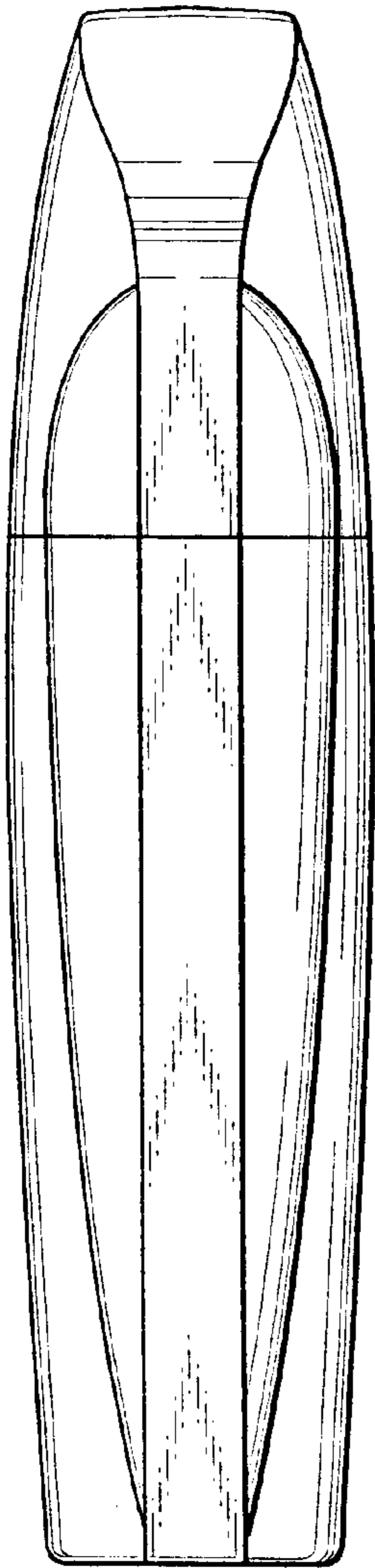

Fig. 5

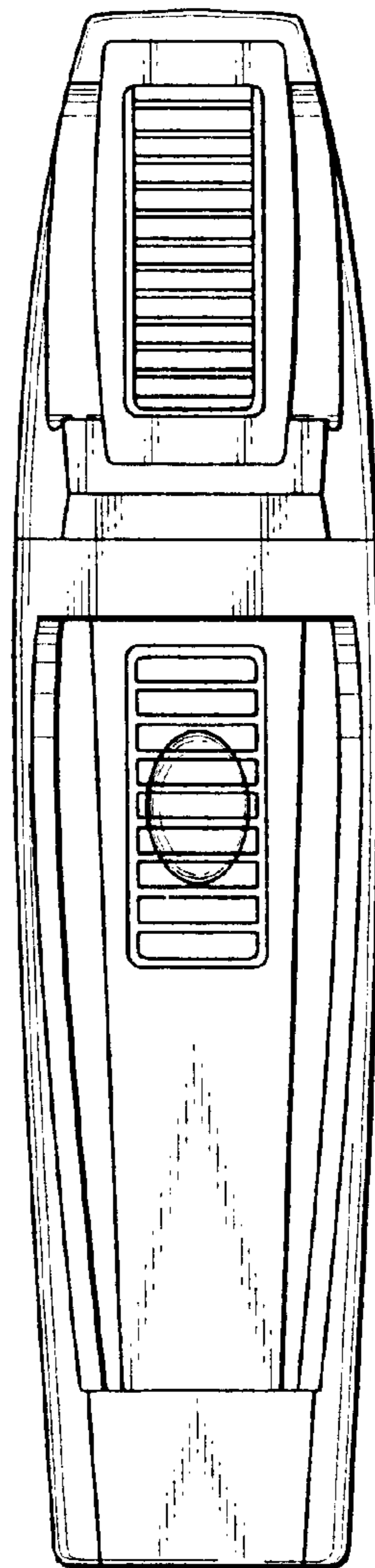

Fig. 6

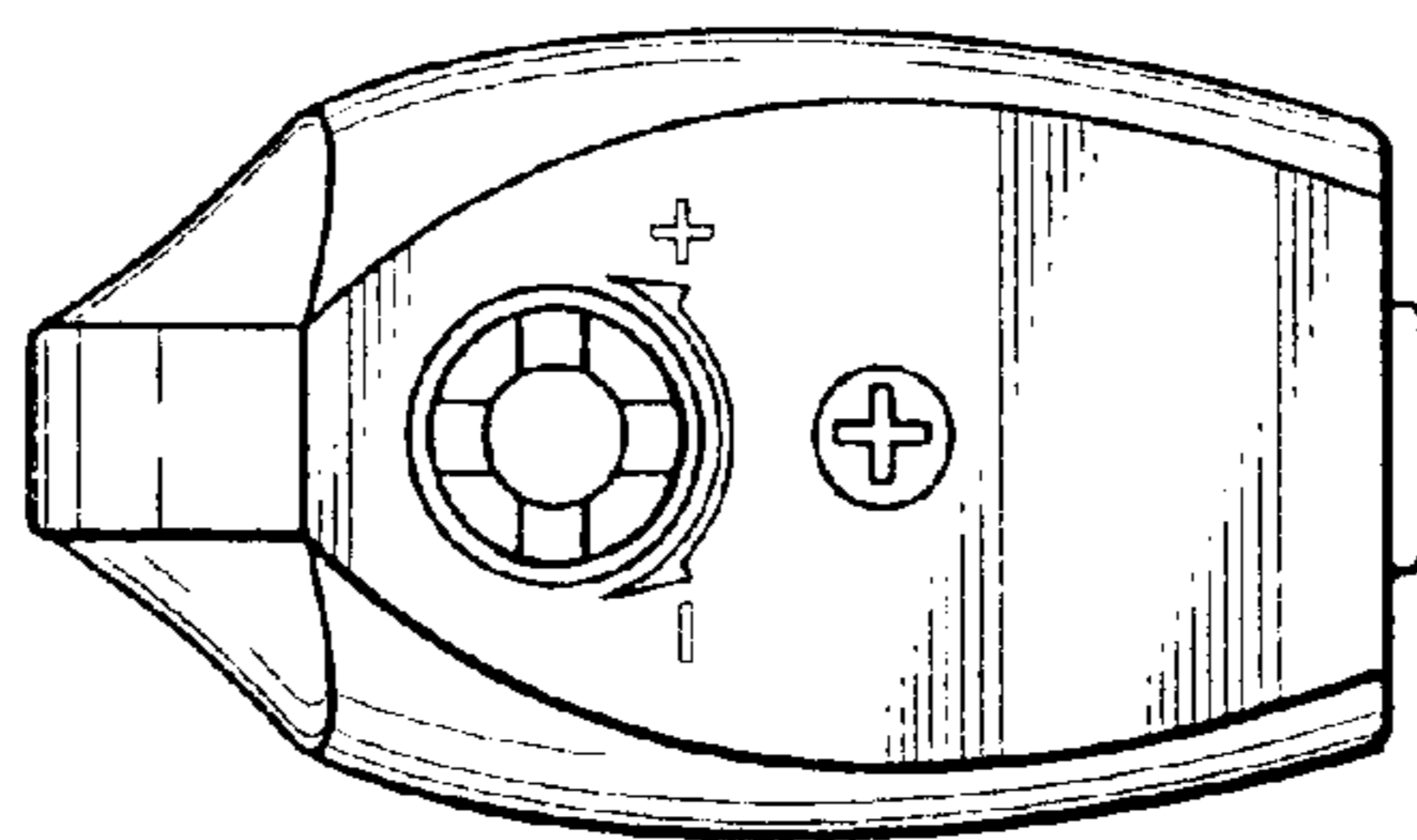
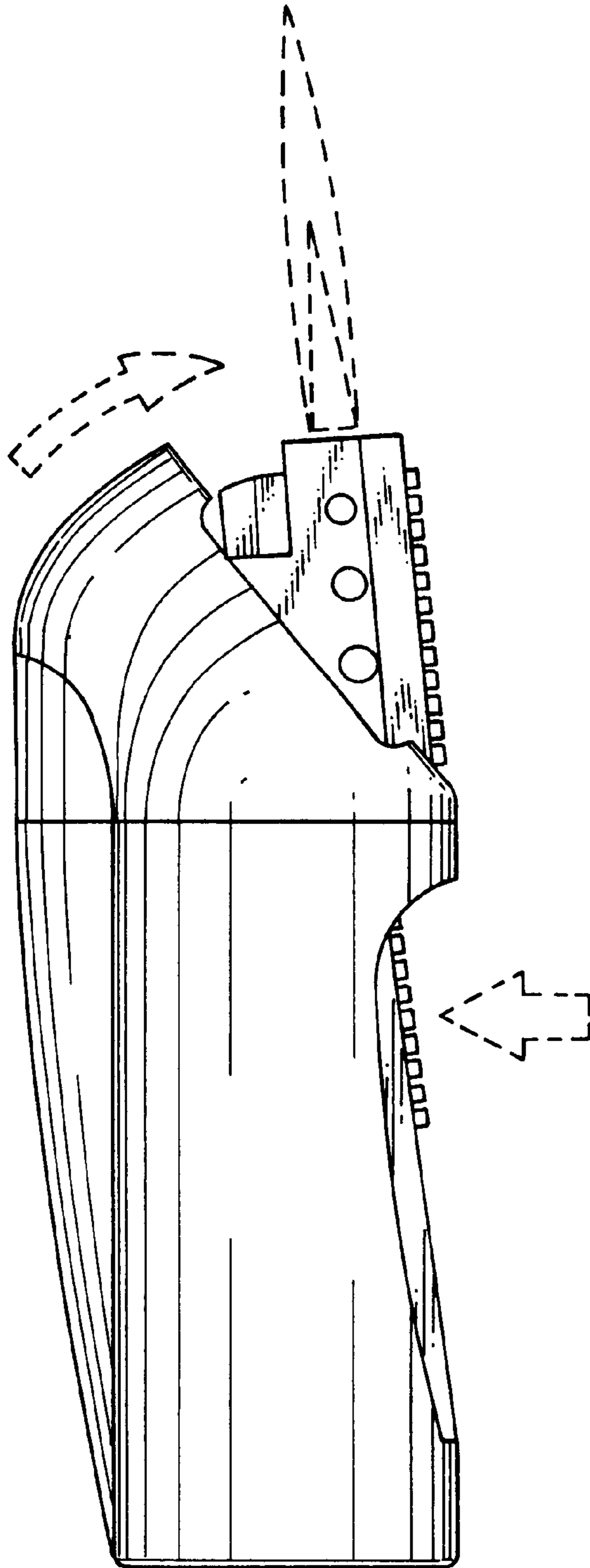

Fig. 7



UNITED STATES PATENT AND TRADEMARK OFFICE
CERTIFICATE OF CORRECTION

PATENT NO. : Des. 462,804 S
DATED : September 10, 2002
INVENTOR(S) : Susumu Maruyama

Page 1 of 1

It is certified that error appears in the above-identified patent and that said Letters Patent is hereby corrected as shown below:

Title page,
Item [75], the Inventor's name should read

-- [75] Inventor: **Susumu Maruyama**, Tokyo (JP) --

Signed and Sealed this

Thirty-first Day of December, 2002

A handwritten signature in black ink, appearing to read "James E. Rogan", written over a horizontal line.

JAMES E. ROGAN
Director of the United States Patent and Trademark Office