



US00D462762S

(12) **United States Design Patent**
Swenson

(10) **Patent No.:** **US D462,762 S**

(45) **Date of Patent:** **** *Sep. 10, 2002**

(54) **TRANSFER DEVICE**

(75) **Inventor:** **Kirk D. Swenson**, Wayne, NJ (US)

(73) **Assignee:** **Becton Dickinson and Company**,
Franklin Lakes, NJ (US)

(*) **Notice:** This patent is subject to a terminal disclaimer.

(**) **Term:** **14 Years**

(21) **Appl. No.:** **29/146,238**

(22) **Filed:** **Aug. 7, 2001**

(51) **LOC (7) Cl.** **24-02**

(52) **U.S. Cl.** **D24/130; D24/129**

(58) **Field of Search** D24/130, 129,
D24/112, 108, 167, 169, 164; 604/411,
263, 533, 535, 539, 7, 8, 6.15, 198; 600/576,
578, 573

(56) **References Cited**

U.S. PATENT DOCUMENTS

D303,013 S * 8/1989 Konopka D24/129

4,991,601 A * 2/1991 Kasai et al. 600/576
D323,710 S * 2/1992 Kasai et al. D24/130
D408,079 S * 4/1999 Ellis D24/108

* cited by examiner

Primary Examiner—Ian Simmons

(74) *Attorney, Agent, or Firm*—Nanette S. Thomas, Esq.

(57) **CLAIM**

The ornamental design of a transfer device, as shown.

DESCRIPTION

FIG. 1 is a perspective view of the transfer device;
FIG. 2 is a front elevational view thereof;
FIG. 3 is a left side elevational view thereof;
FIG. 4 is a right side elevational view thereof;
FIG. 5 is a top plan view thereof;
FIG. 6 is a bottom plan view thereof; and,
FIG. 7 is a rear elevational view thereof.

1 Claim, 6 Drawing Sheets

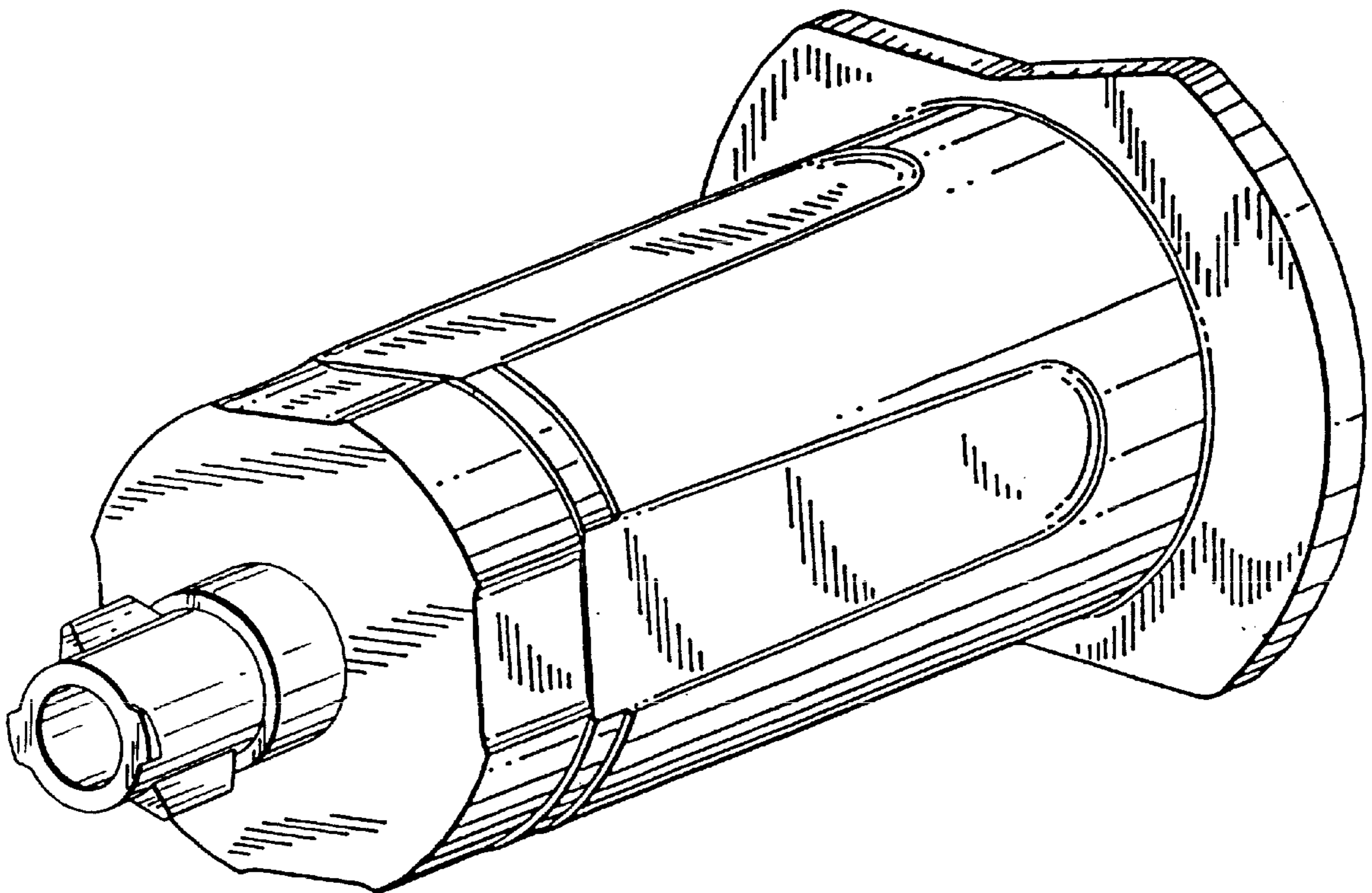

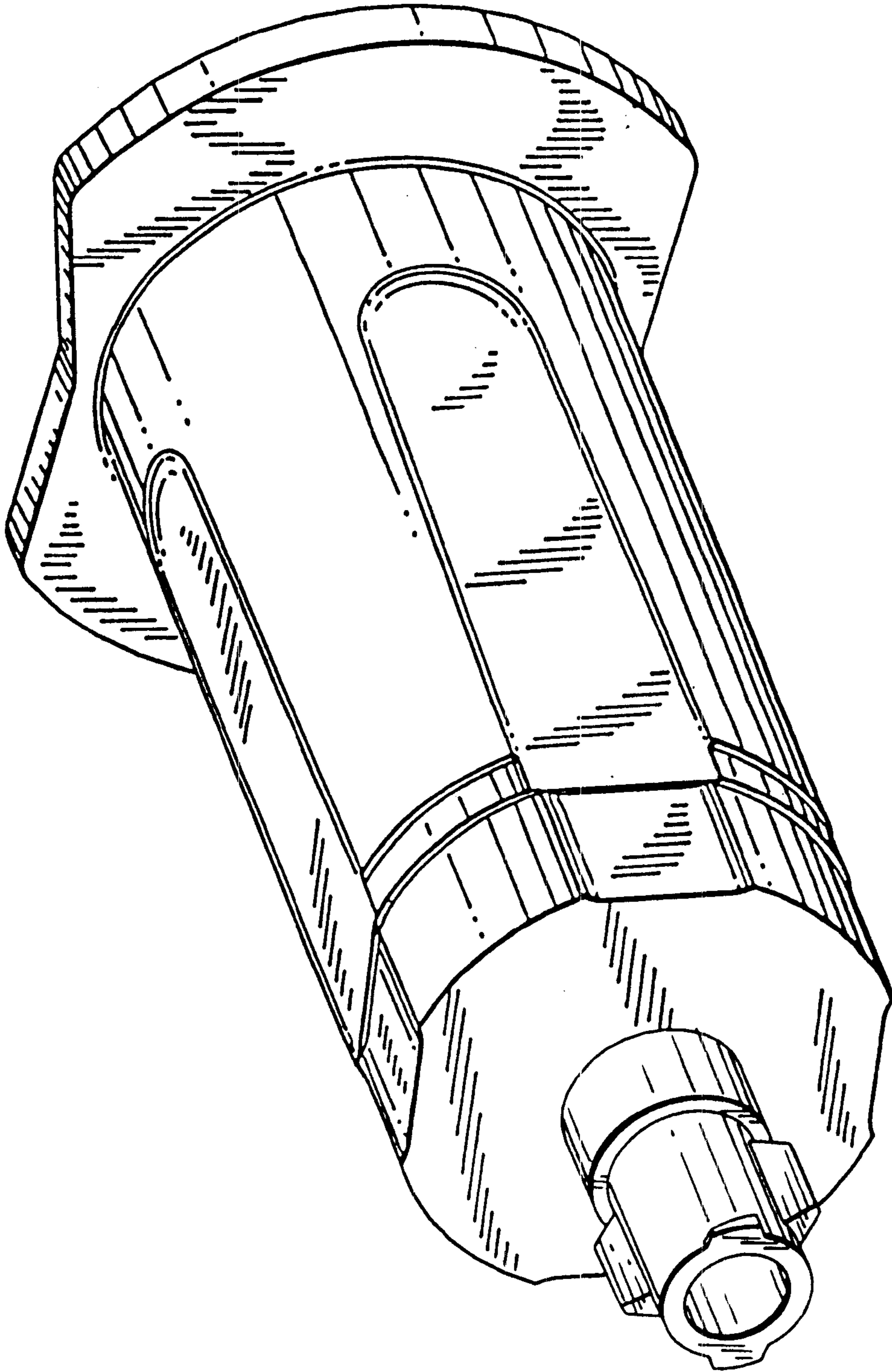

FIG.1

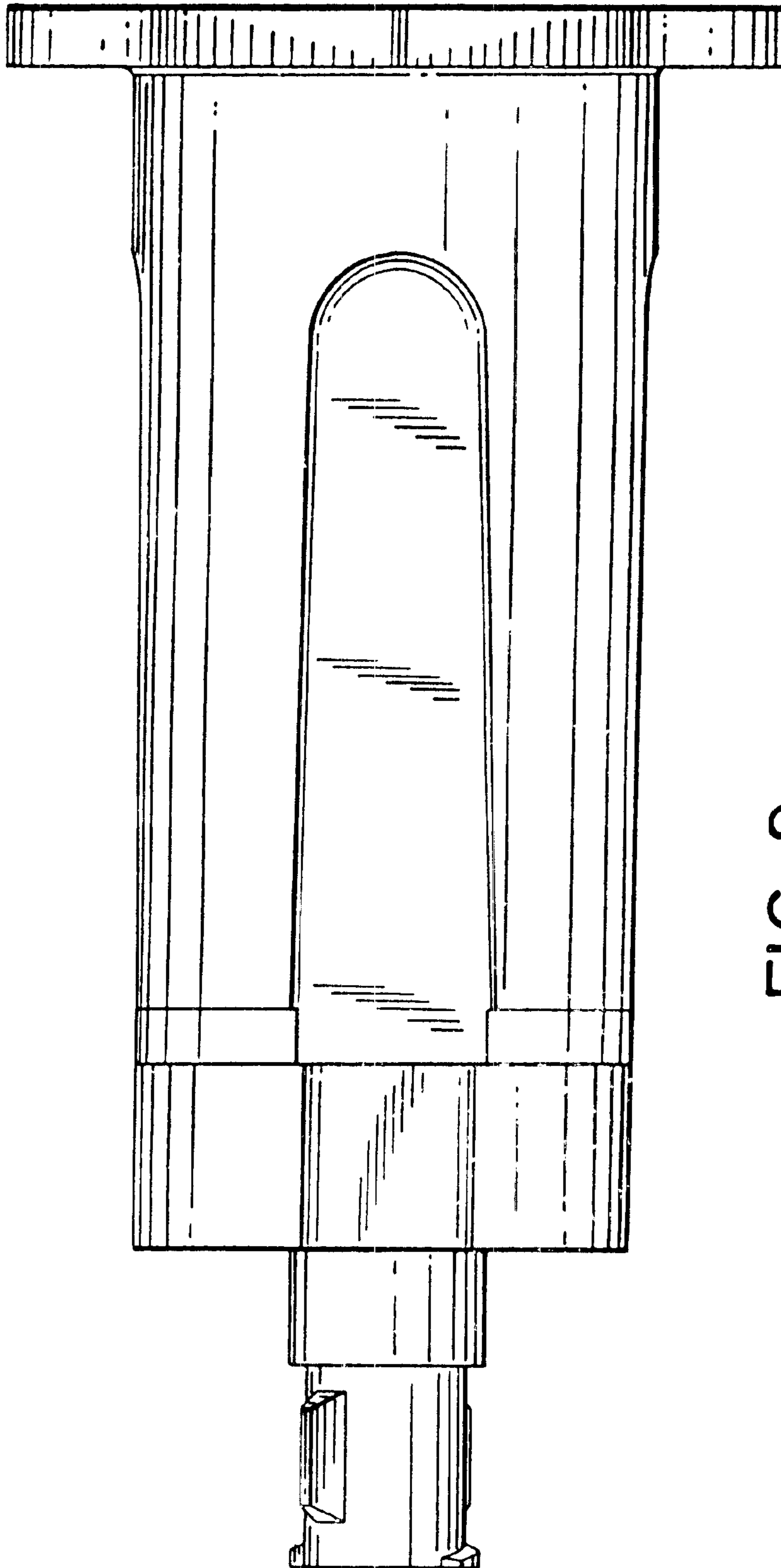

FIG. 2

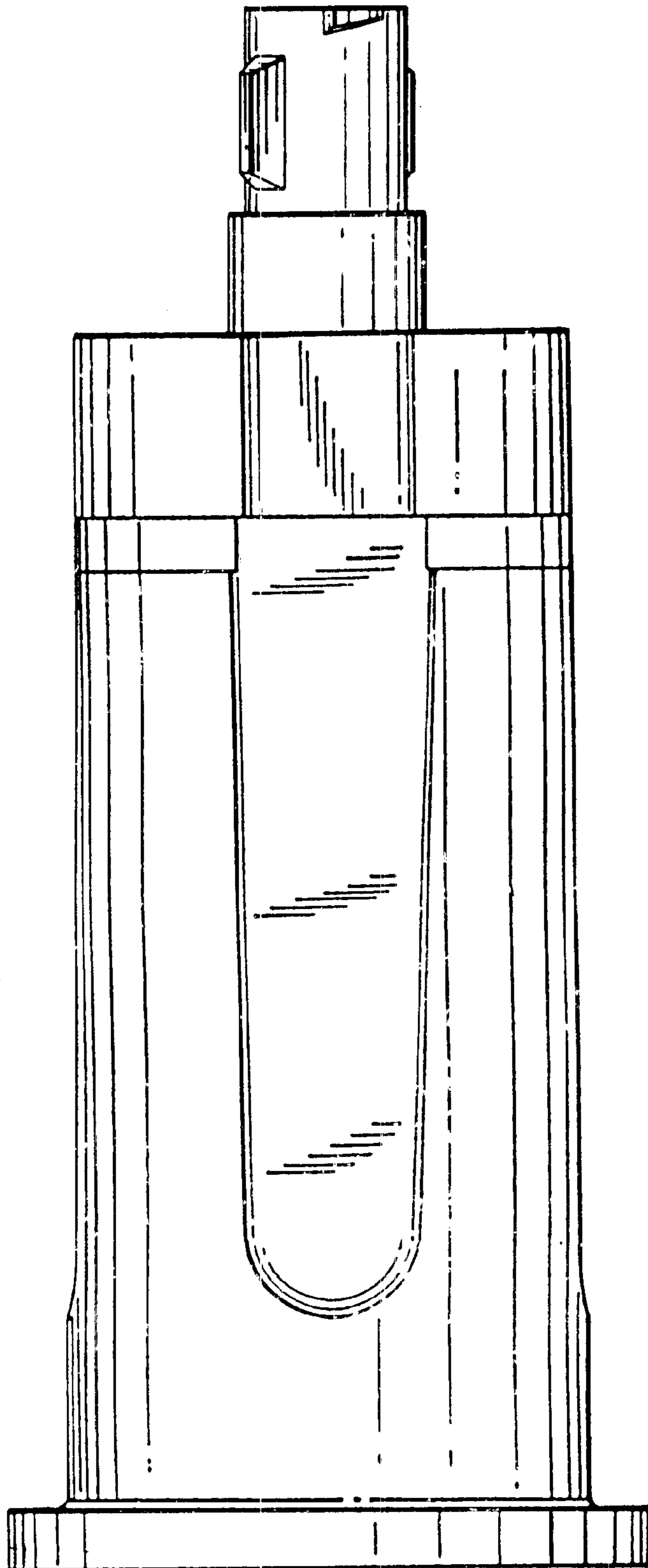

FIG. 3

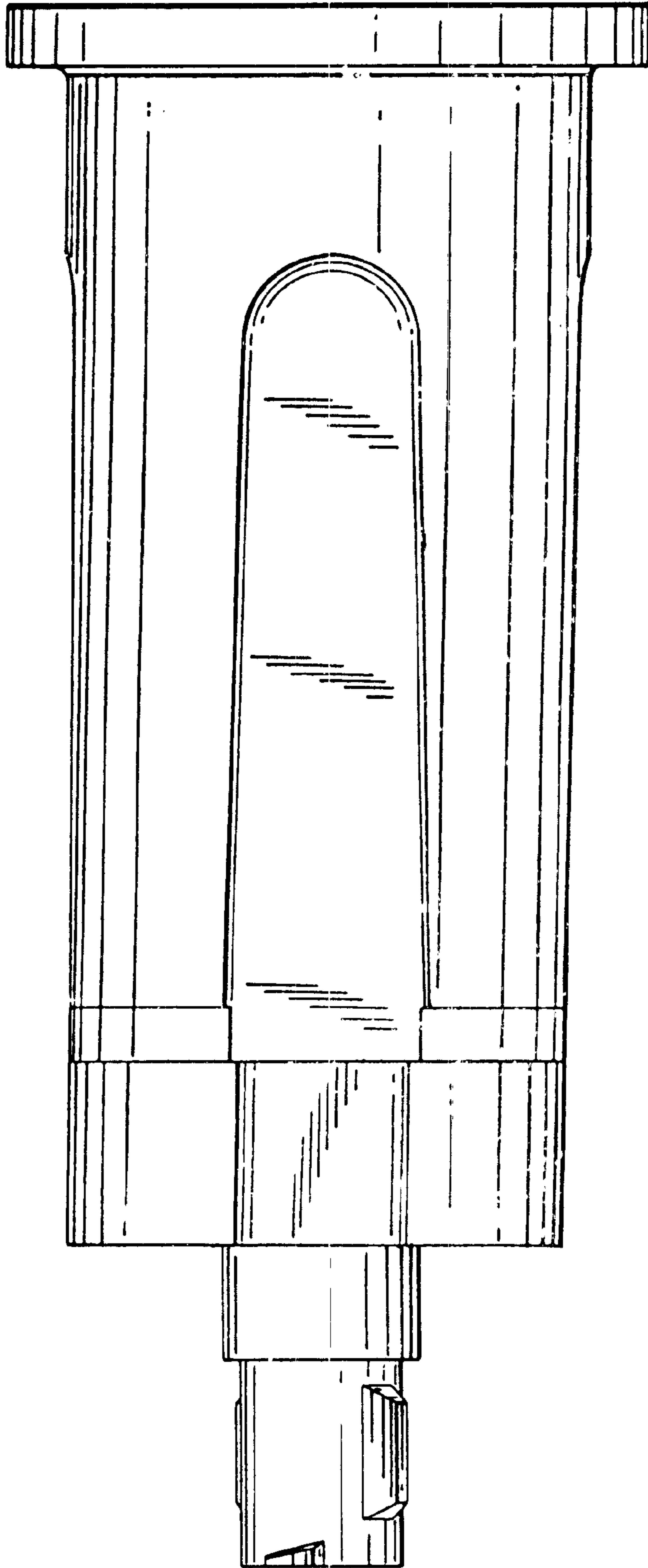

FIG. 4

FIG.5

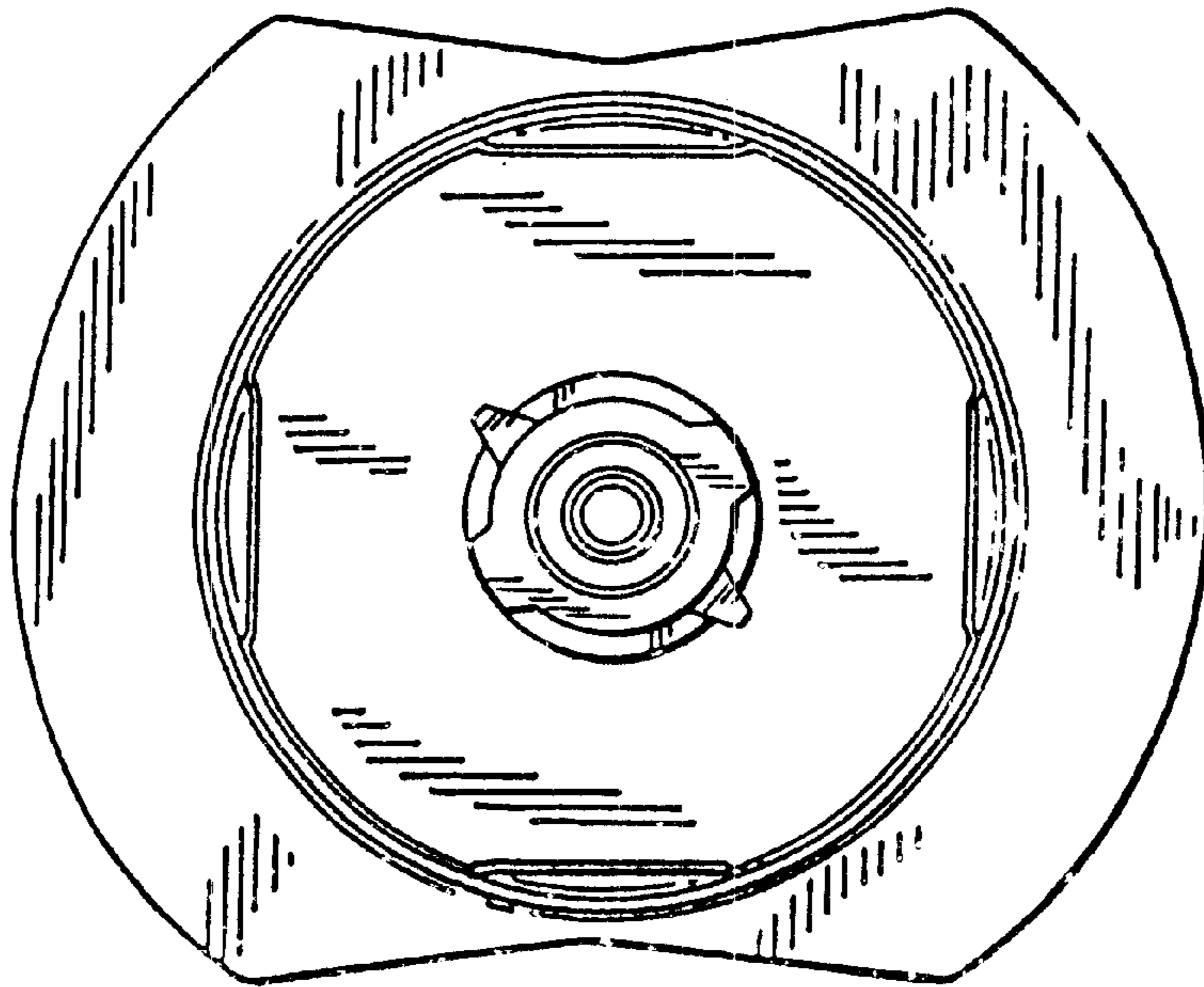
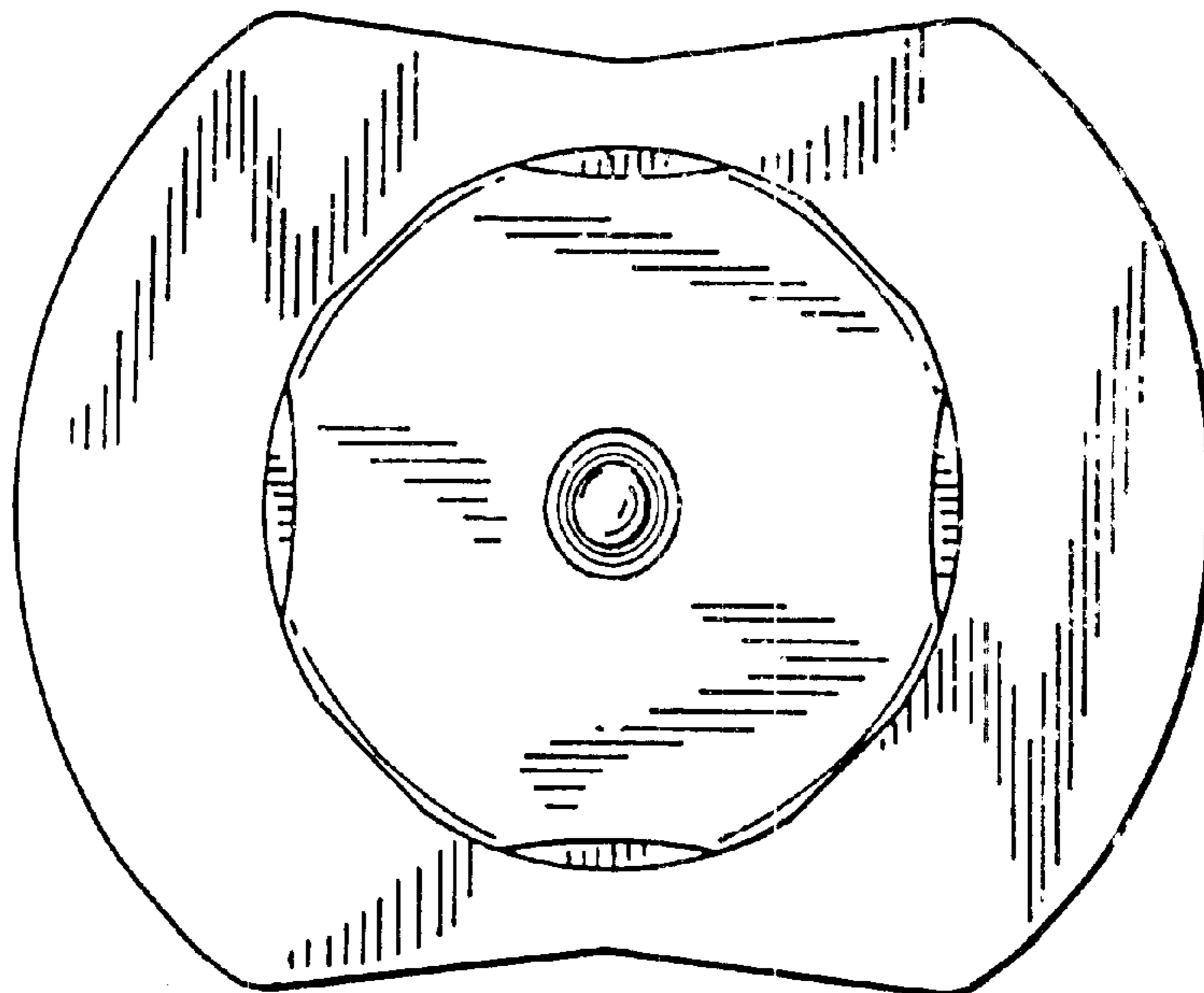

FIG.6



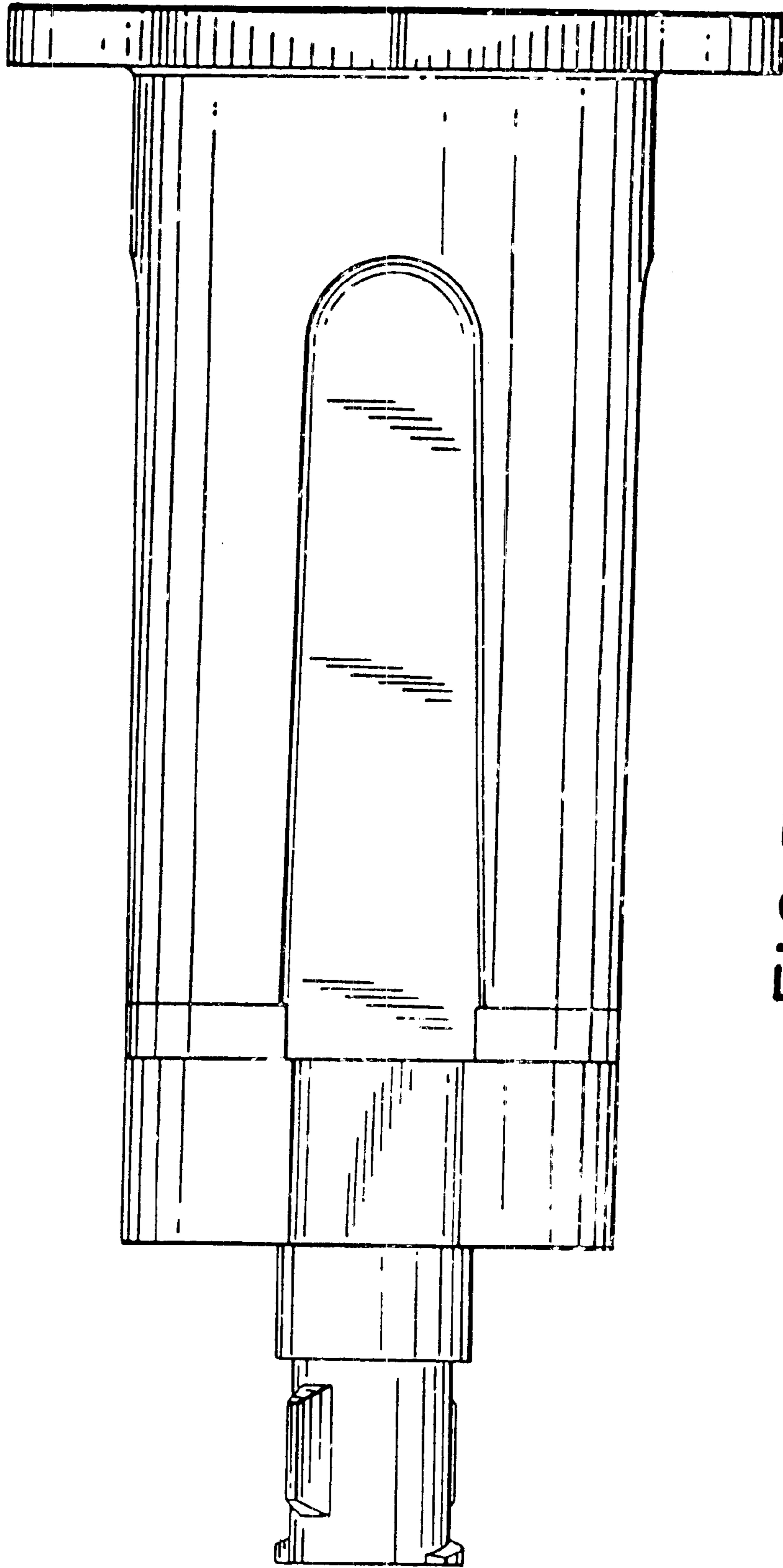

FIG. 7