



US00D462754S

(12) **United States Design Patent**
Briggs et al.

(10) **Patent No.: US D462,754 S**

(45) **Date of Patent: ** *Sep. 10, 2002**

(54) **ROOM AIR PURIFIER DEVICE**

(75) Inventors: **Richard T. Briggs**, Kirkville; **William Schuettenberg**, Manlius; **William O'Hara**, Jamesville; **Vincent G. Lobdell**, Pulaski; **Max Bablok**, Liverpool; **Scott W. Osiecki**, Skaneateles; **Robert S. Englert**, Syracuse, all of NY (US); **Gregg W. Harvey**, Arvada, CO (US)

(73) Assignee: **Healthway Products Company, Inc.**, Syracuse, NY (US)

(*) Notice: This patent is subject to a terminal disclaimer.

(**) Term: **14 Years**

(21) Appl. No.: **29/109,409**

(22) Filed: **Aug. 13, 1999**

(51) **LOC (7) Cl.** **23-04**

(52) **U.S. Cl.** **D23/364**

(58) **Field of Search** D23/364, 355,
D23/365; 96/97

(56) **References Cited**

U.S. PATENT DOCUMENTS

D416,614 S * 11/1999 Bellil et al. D23/364

* cited by examiner

Primary Examiner—Lisa Lichtenstein

(74) *Attorney, Agent, or Firm*—George R. McGuire; Hancock & Estabrook, LLP

(57) **CLAIM**

The ornamental design for a room air purifier device, as shown.

DESCRIPTION

FIG. 1 is a top perspective view of a room air purifier device showing our new design;

FIG. 2 is a bottom perspective view thereof;

FIG. 3 is a front elevational view thereof;

FIG. 4 is a back elevational view thereof;

FIG. 5 is a right side elevational view thereof;

FIG. 6 is a left side elevational view thereof;

FIG. 7 is a top plan view thereof; and,

FIG. 8 is a bottom plan view thereof.

1 Claim, 5 Drawing Sheets

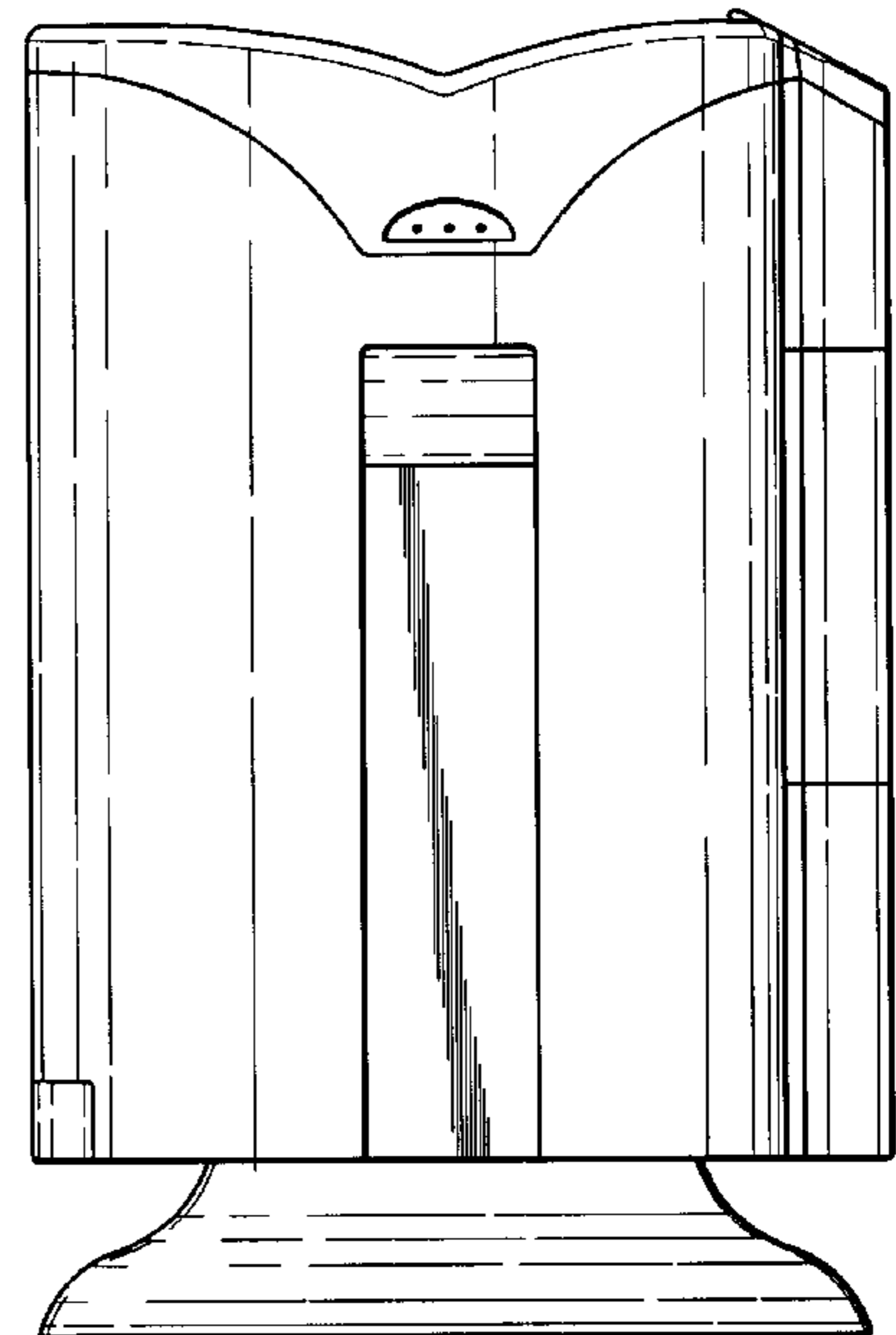
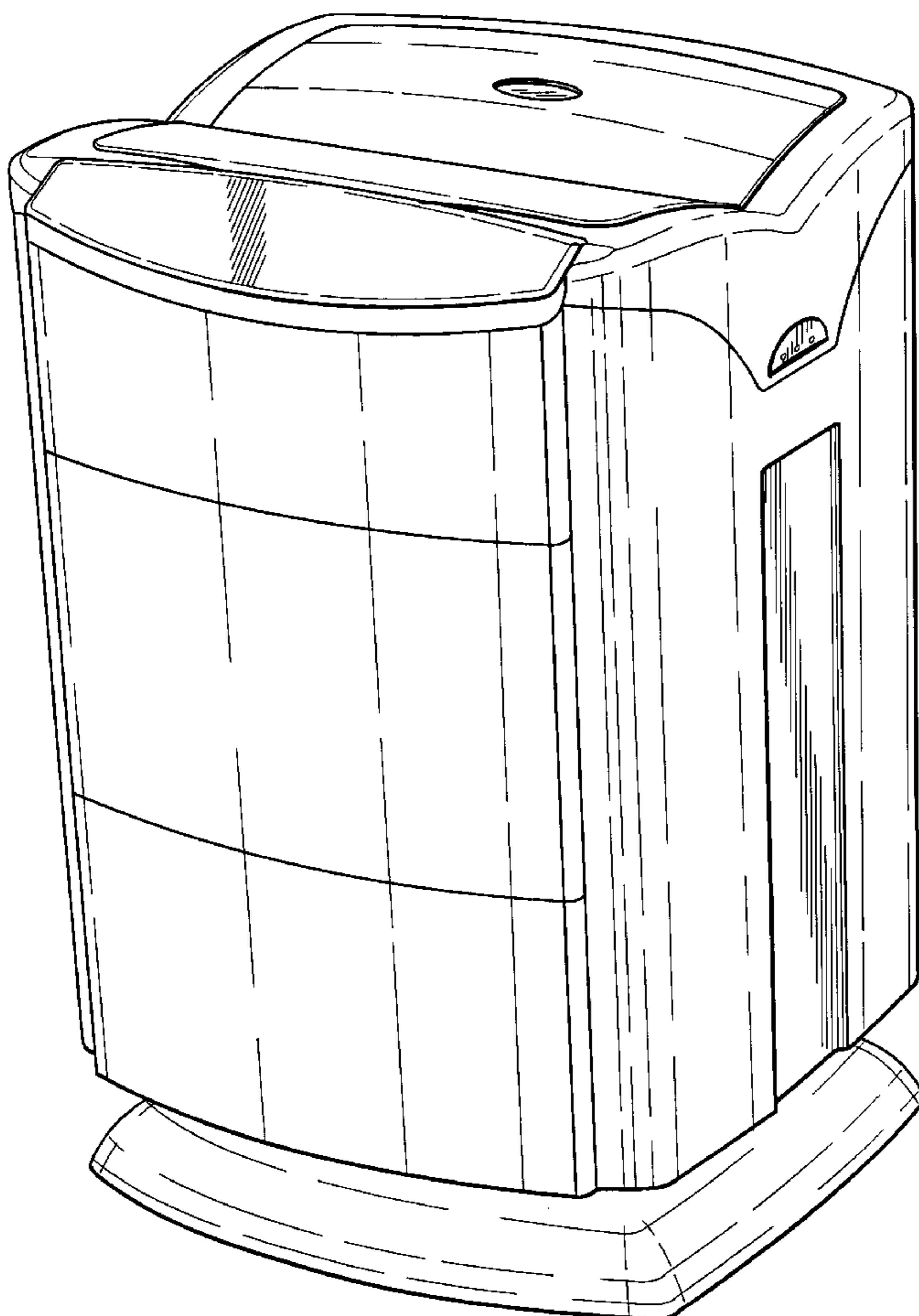

Fig. 1

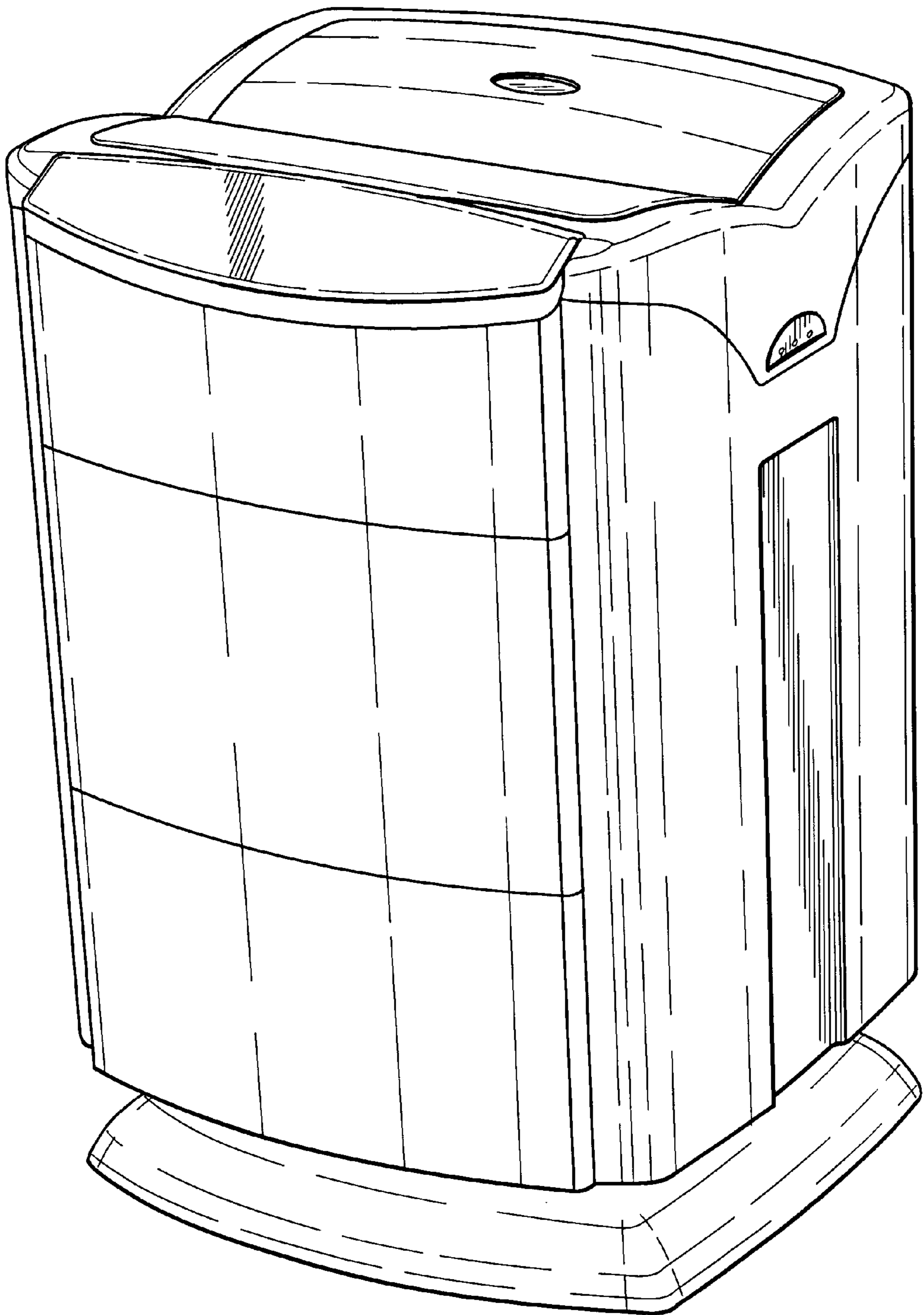

Fig. 2

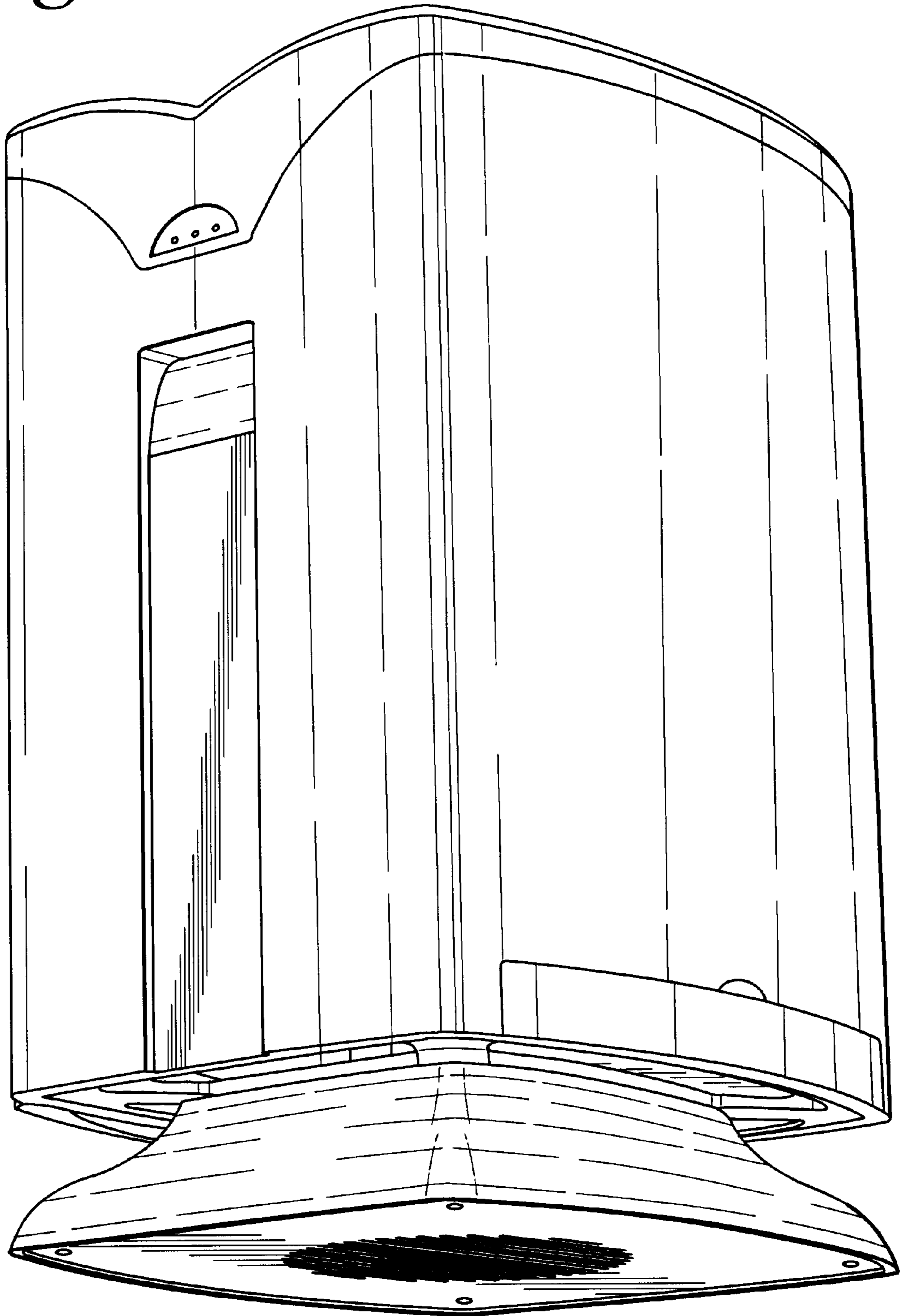

Fig. 3

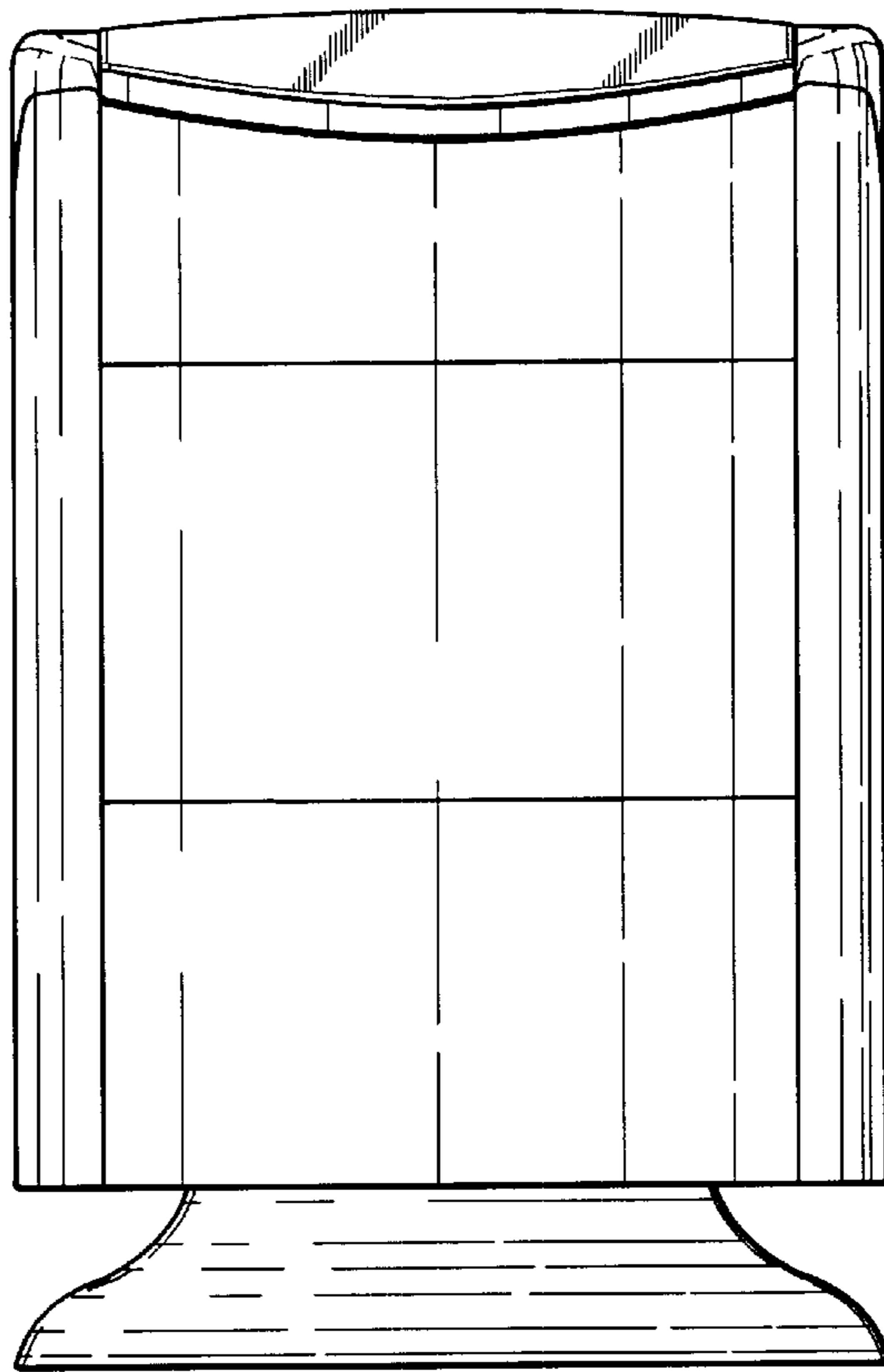

Fig. 4

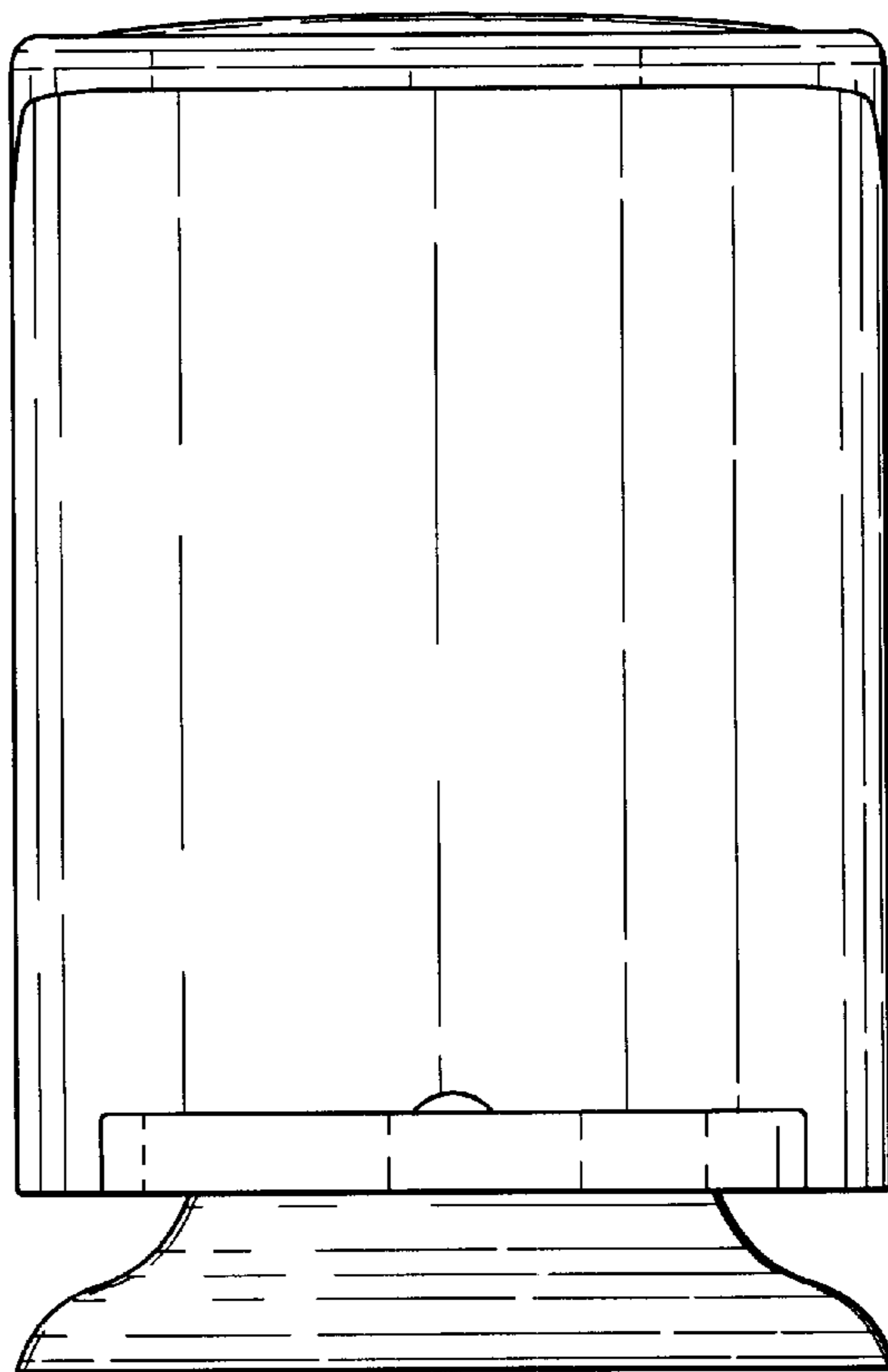

Fig. 5

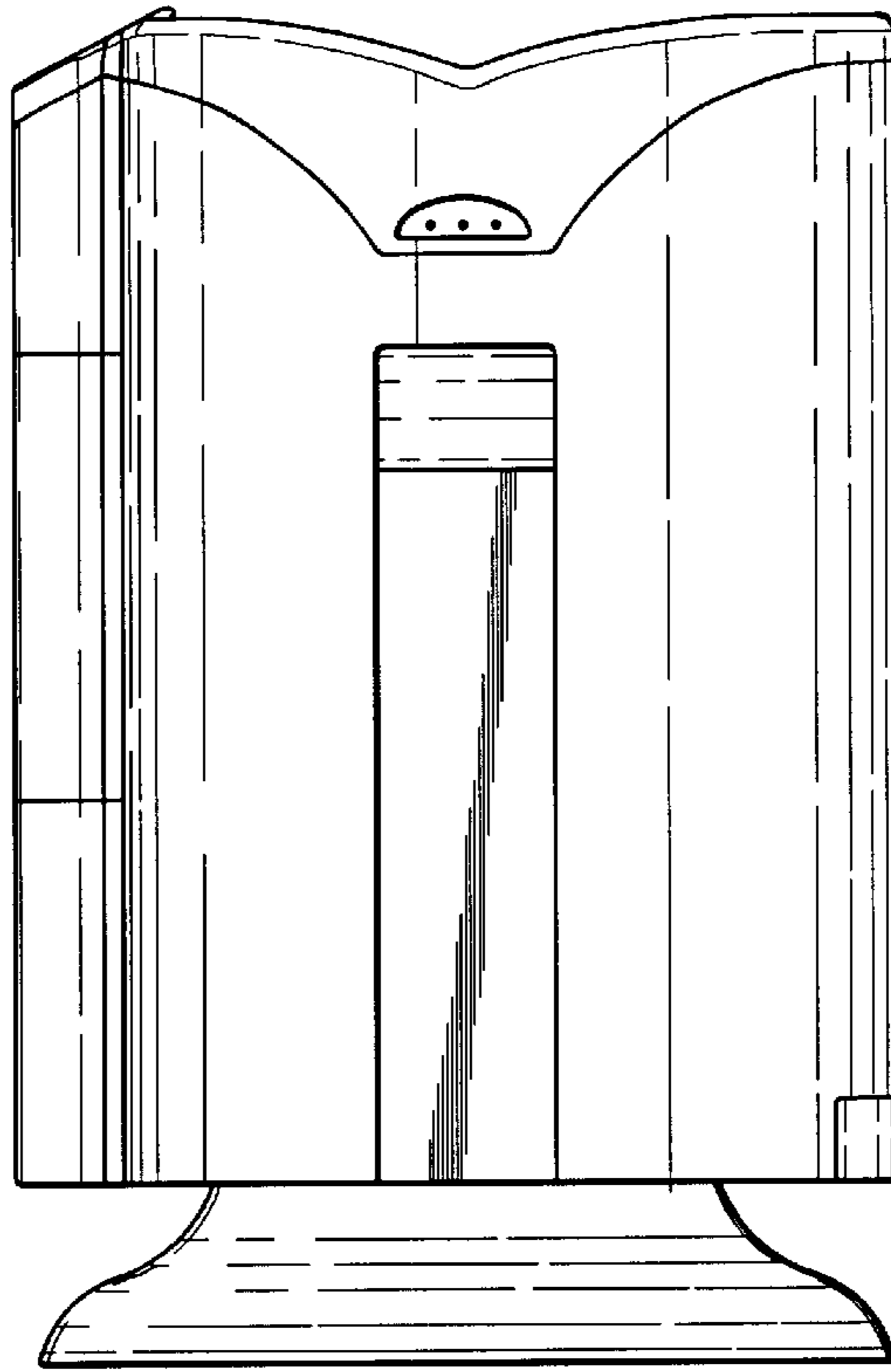

Fig. 6

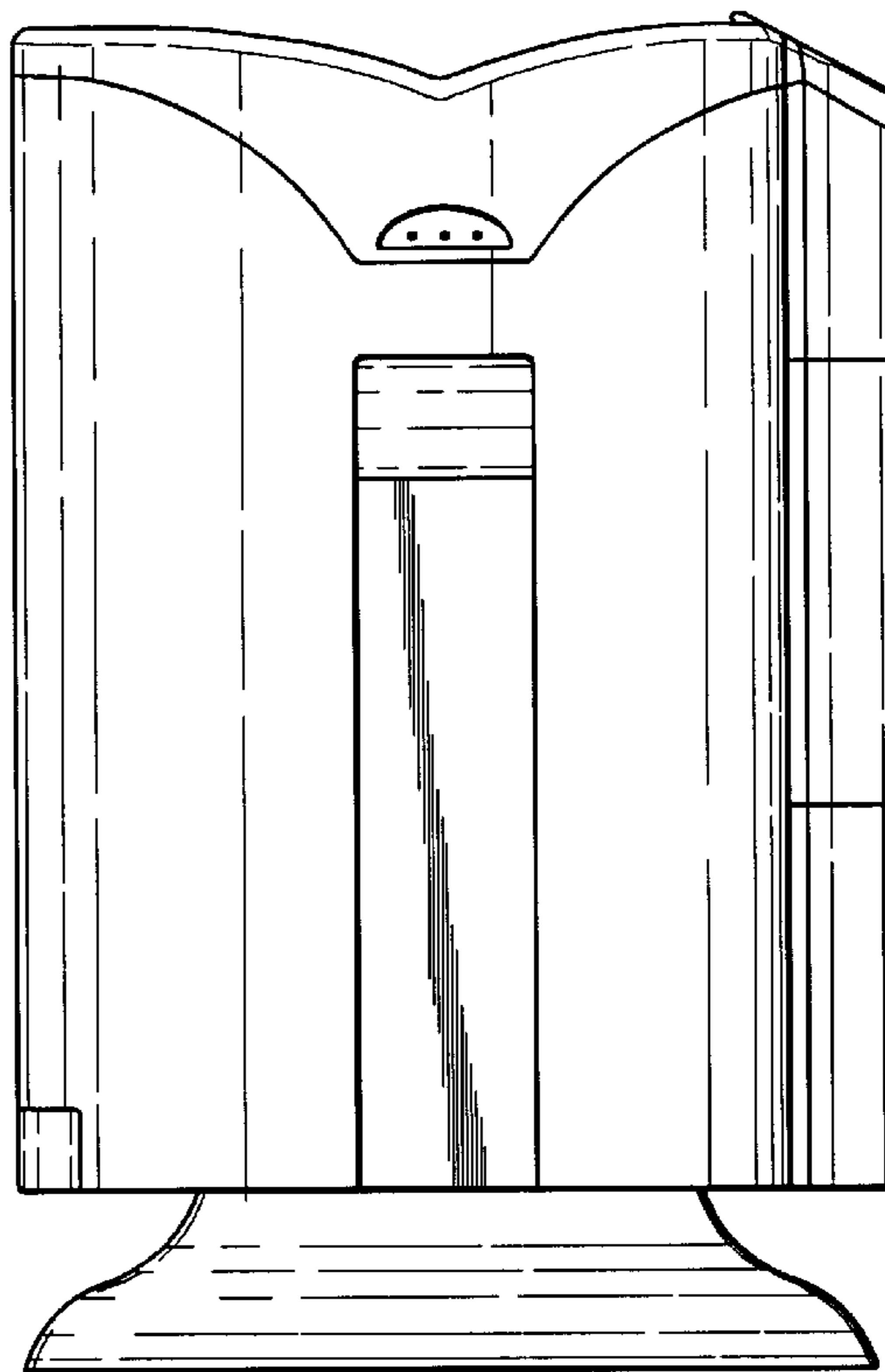

Fig. 7

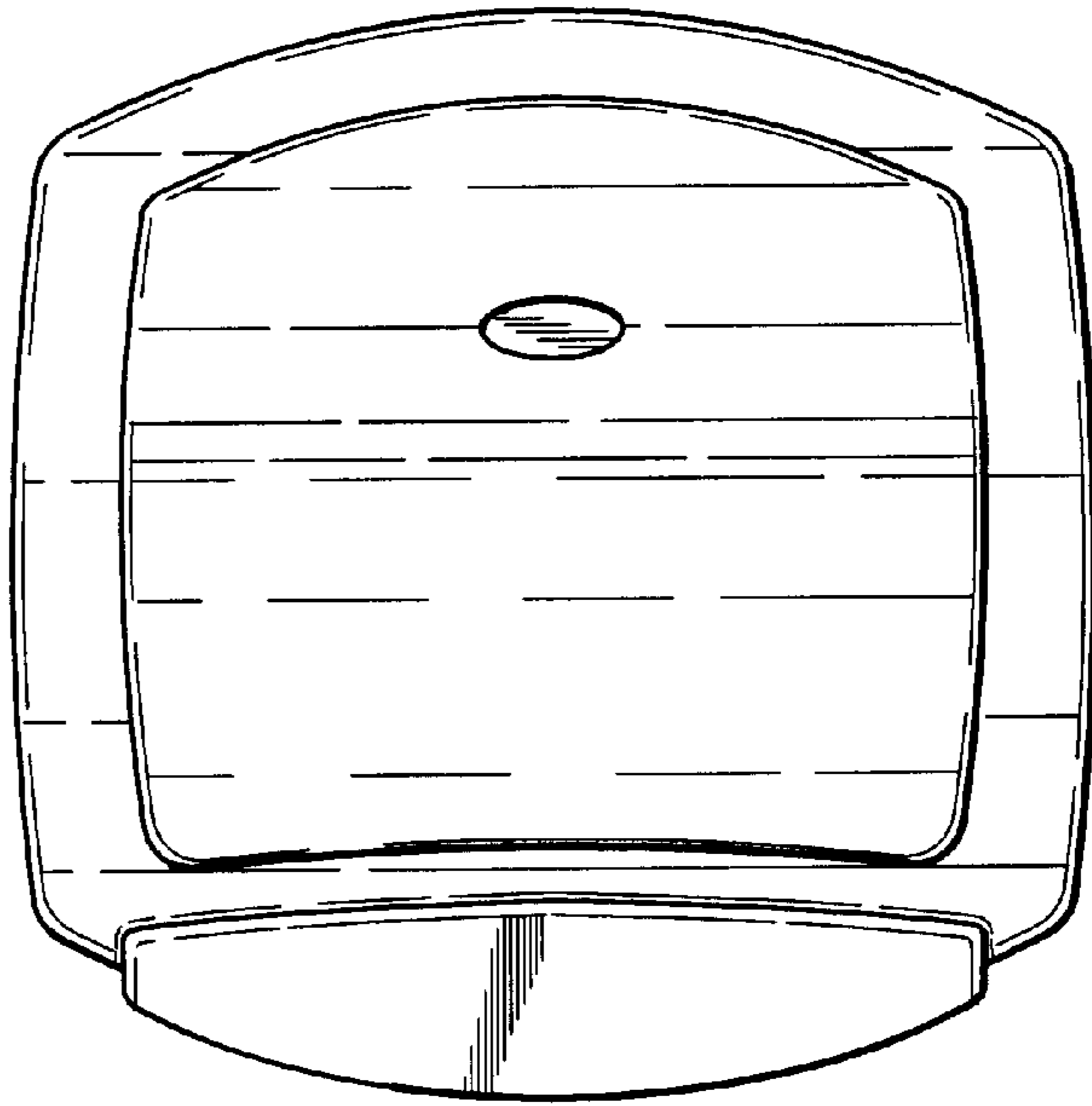

Fig. 8

