



US00D462591S

(12) **United States Design Patent**
Gist

(10) **Patent No.:** **US D462,591 S**

(45) **Date of Patent:** **** Sep. 10, 2002**

(54) **CORDLESS JIG SAW**

(75) Inventor: **Leslie Daily Gist**, Jackson, TN (US)

(73) Assignee: **Porter-Cable/Delta**, Jackson, TN (US)

(**) Term: **14 Years**

(21) Appl. No.: **29/150,084**

(22) Filed: **Nov. 5, 2001**

(51) **LOC (7) Cl.** **08-03**

(52) **U.S. Cl.** **D8/64**

(58) **Field of Search** D8/61, 62, 63,
D8/64, 66, 67, 68, 69, 70; 30/374, 375,
376, 377, 388, 389, 390, 391, 392, 393,
394; 173/15, 47, 48, 109, 169, 170, 216,
217; 310/50

(56) **References Cited**

U.S. PATENT DOCUMENTS

| | | | | | |
|--------------|---|---------|------------------|-------|--------|
| D191,570 S | * | 10/1961 | Downs | | D8/64 |
| 5,035,059 A | * | 7/1991 | Takahashi et al. | | 30/273 |
| D420,876 S | * | 2/2000 | Bosten et al. | | D8/64 |
| 6,241,027 B1 | * | 6/2001 | Beck et al. | | 30/392 |
| D446,703 S | * | 8/2001 | Netzler | | D8/64 |

OTHER PUBLICATIONS

Makita Industrial Power Tools 1999–2000 General Catalog,
p. 16, 4332 DWA Cordless Jig Saw.
Porter–Cable 1999–2000 Catalog, p. 14, 9543 Jig Saw.

DeWalt 2000 Catalog, p. 16, DW933K/933 18V Cordless
Jig Saw.

* cited by examiner

Primary Examiner—Doris V. Coles

Assistant Examiner—Elizabeth A. Albert

(74) *Attorney, Agent, or Firm*—Hunton & Williams

(57) **CLAIM**

The ornamental design for a cordless jig saw, as shown and
described.

DESCRIPTION

FIG. 1 is an isometric view of the cordless jig saw.

FIG. 2 is another isometric view of the cordless jig saw of
FIG. 1.

FIG. 3 is a left-side view of the cordless jig saw of FIG. 1.

FIG. 4 is a right-side view of the cordless jig saw of FIG. 1.

FIG. 5 is a top view of the cordless jig saw of FIG. 1; and,

FIG. 6 is a front view of the cordless jig saw of FIG. 1.

The broken line illustration of environmental structure in
FIGS. 1–6 is for illustrative purposes only and forms no part
of the claimed design.

1 Claim, 6 Drawing Sheets

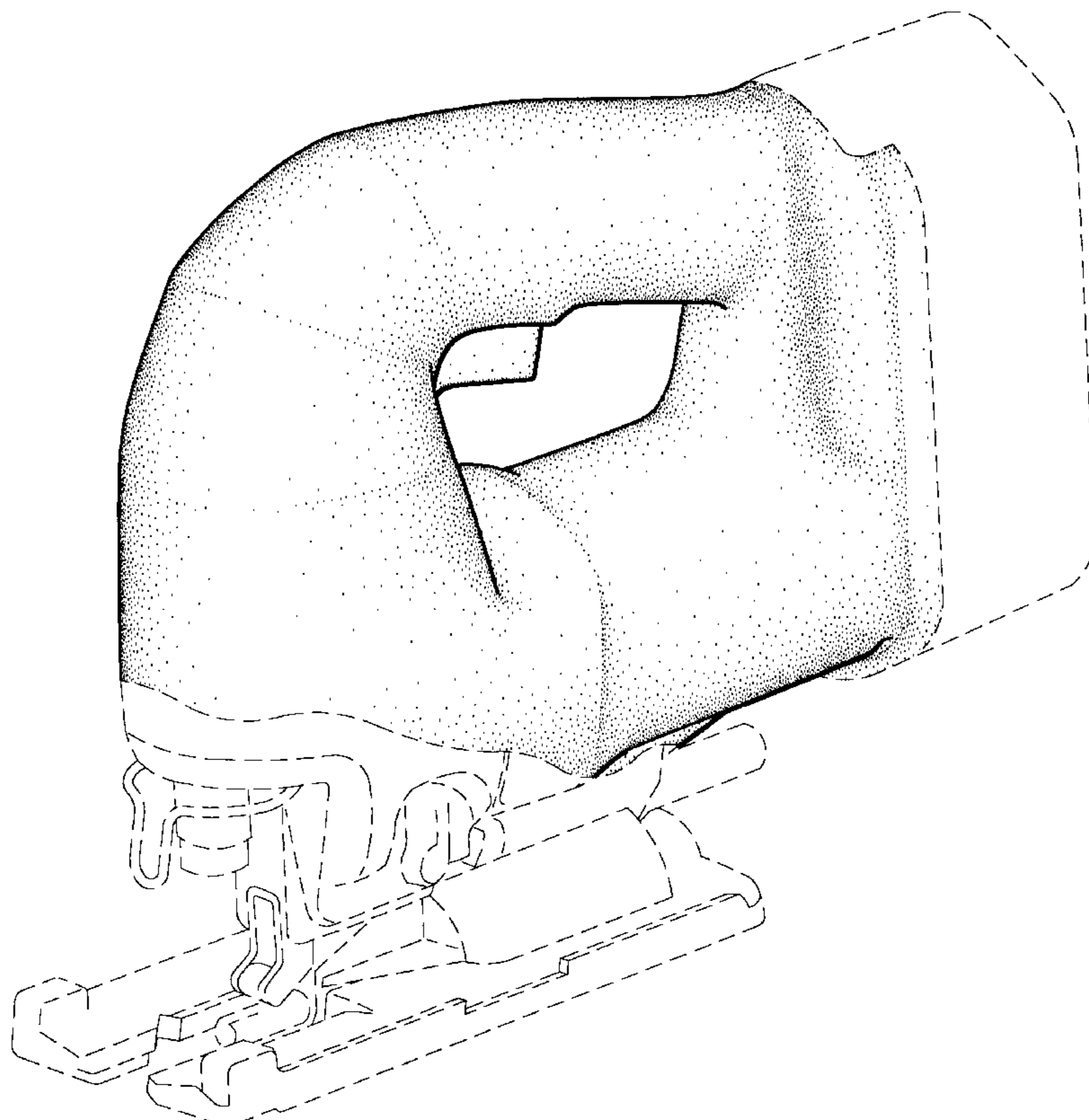

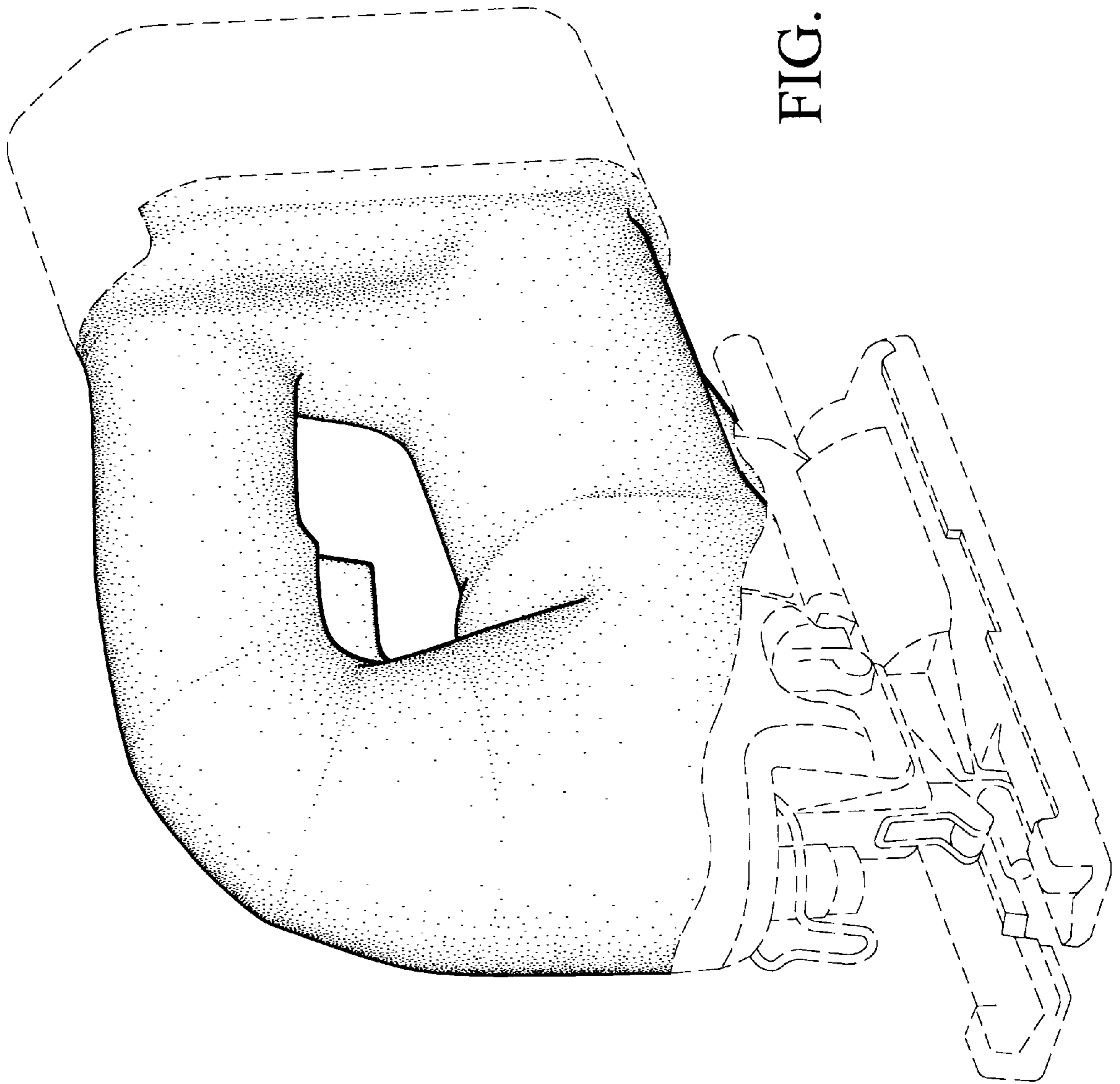

FIG. 1

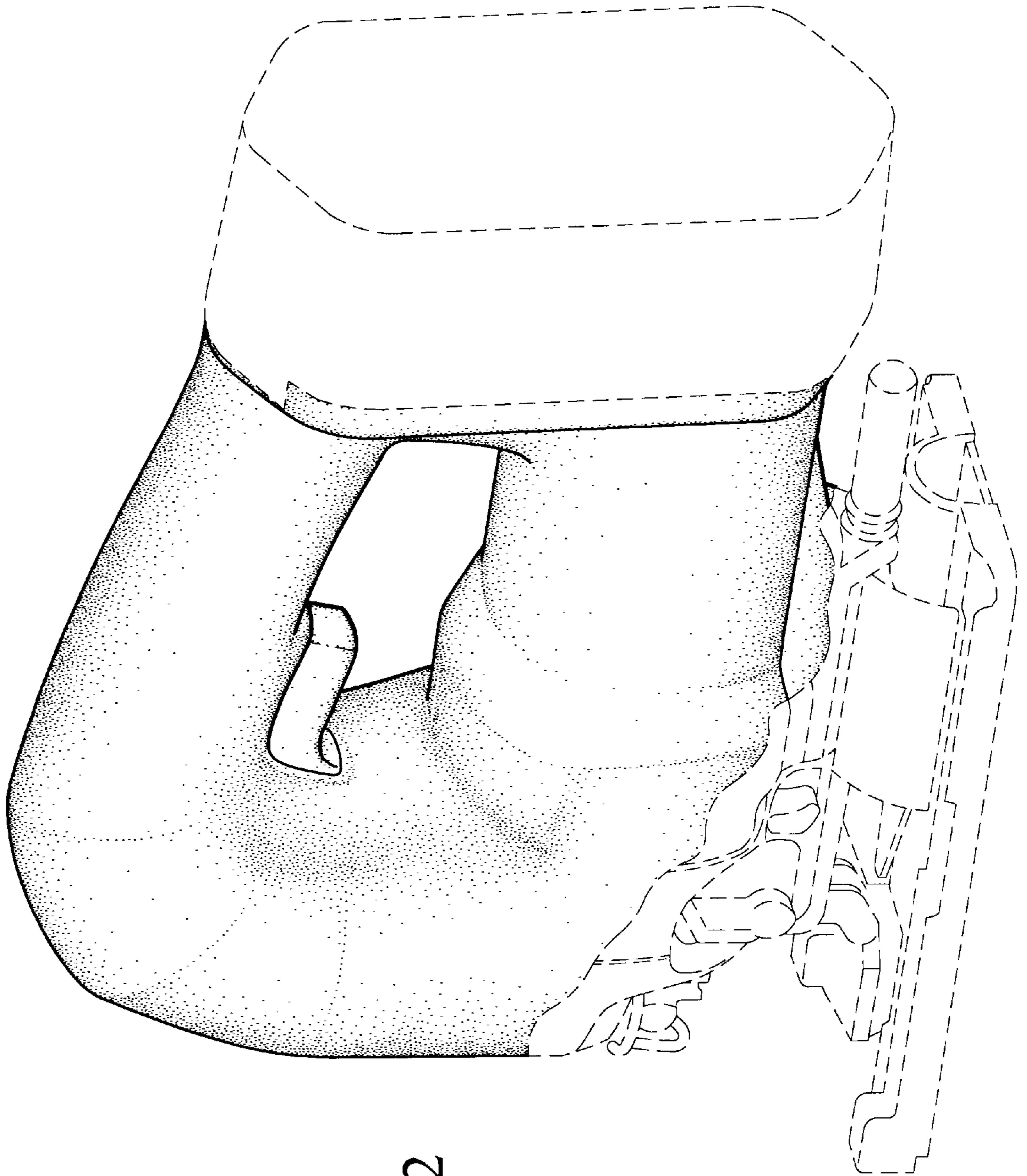

FIG. 2

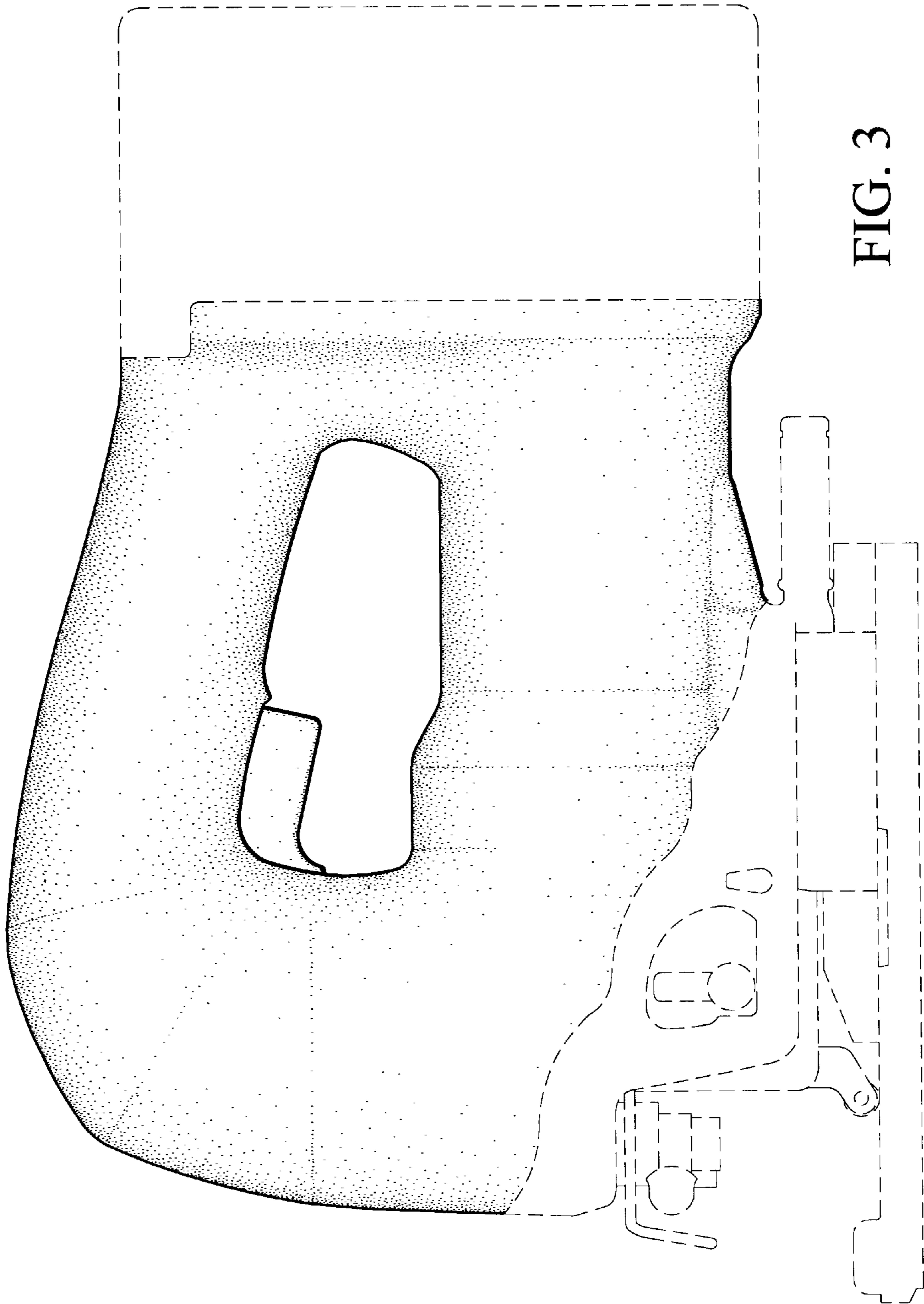

FIG. 3

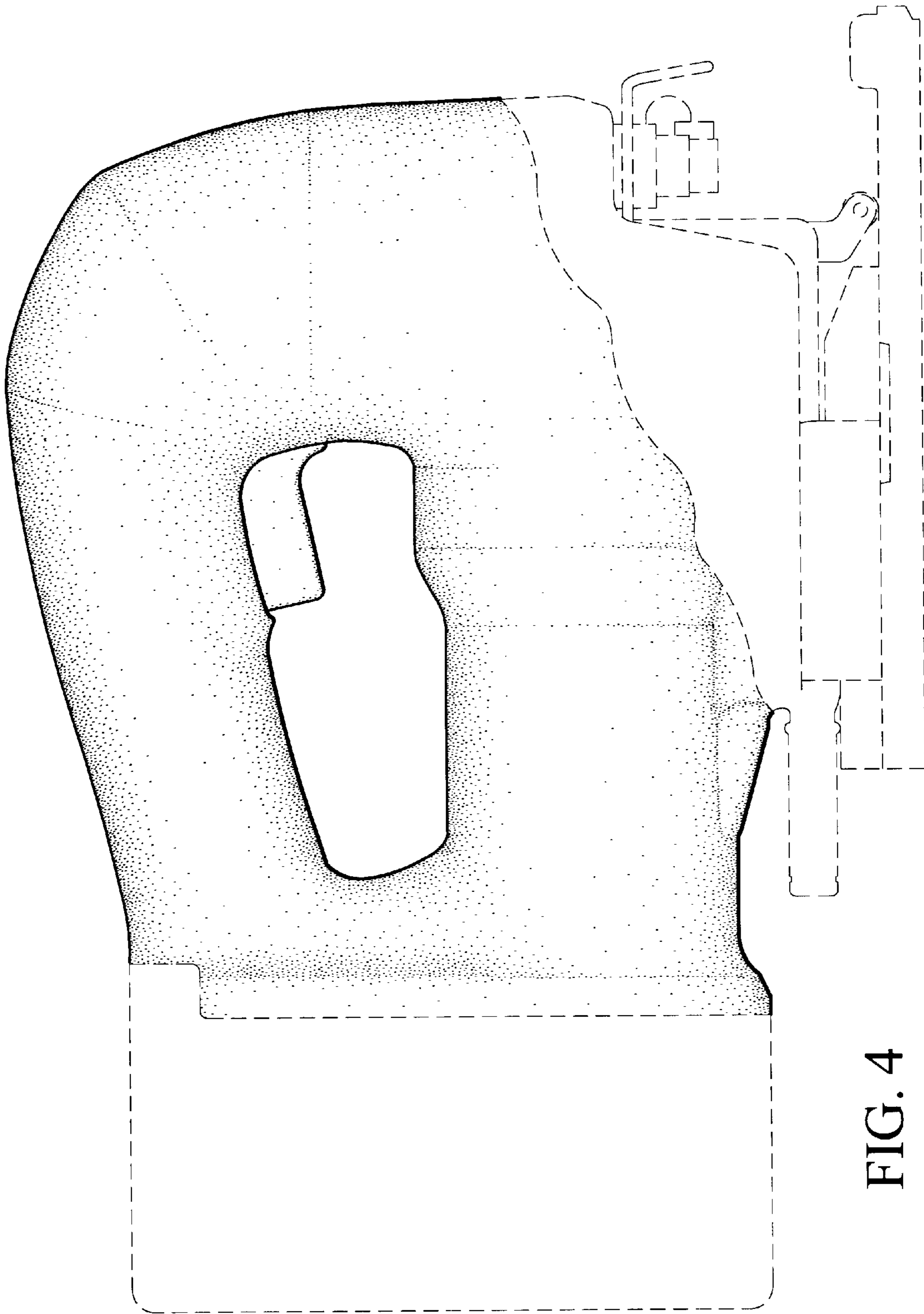

FIG. 4

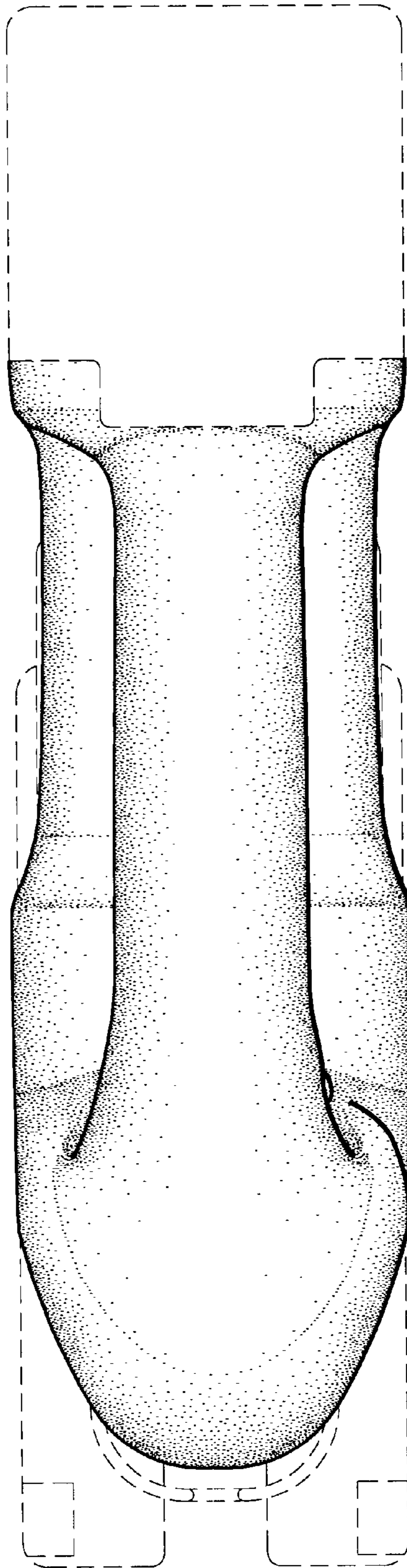

FIG. 5

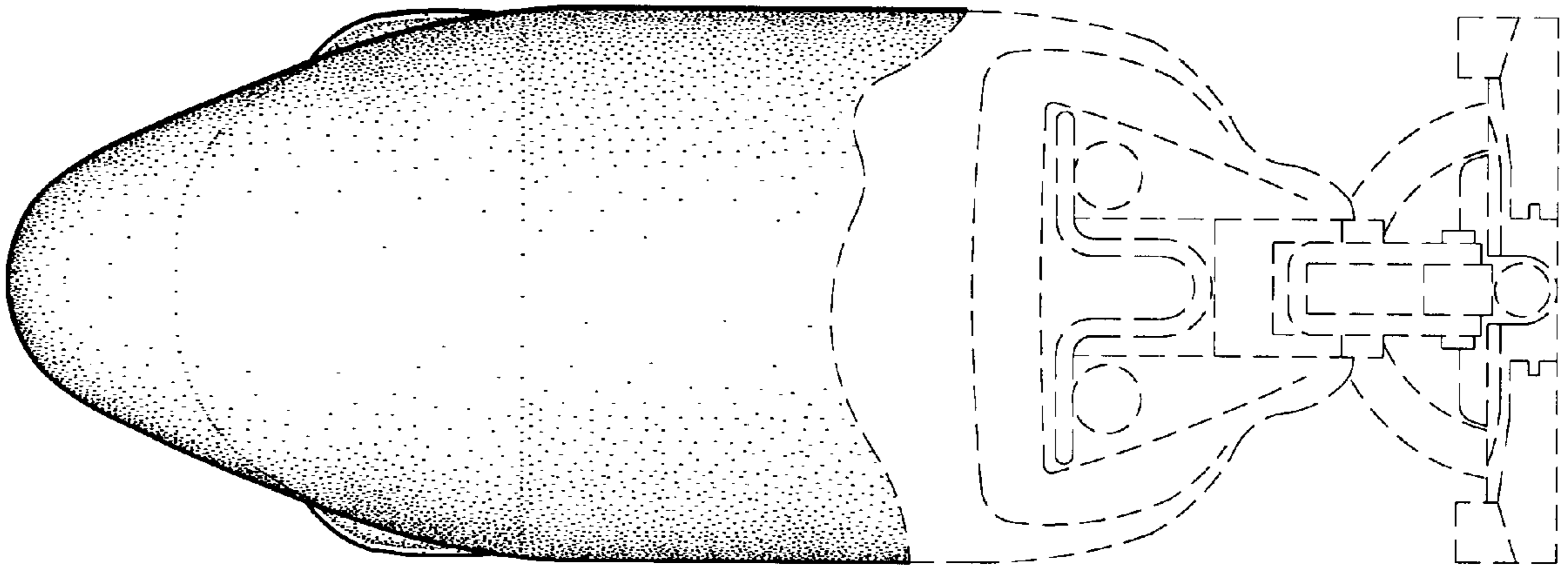

FIG. 6