



US00D462540S

(12) **United States Design Patent**
Lenger

(10) **Patent No.:** **US D462,540 S**

(45) **Date of Patent:** **** Sep. 10, 2002**

(54) **DRESSER**

(75) **Inventor:** **Sidney A. Lenger**, Kernersville, NC (US)

(73) **Assignee:** **Schottenstein Stores Corporation**, Columbus, OH (US)

(**) **Term:** **14 Years**

(21) **Appl. No.:** **29/149,641**

(22) **Filed:** **Oct. 12, 2001**

(51) **LOC (7) Cl.** **06-04**

(52) **U.S. Cl.** **D6/441; D6/446**

(58) **Field of Search** **D6/432-448; 312/204, 312/224, 237, 278, 279**

(56) **References Cited**

U.S. PATENT DOCUMENTS

D327,186 S	*	6/1992	Tarlow	D6/441
D371,257 S	*	7/1996	Paus	D6/445
D375,514 S	*	11/1996	Keller et al.	D6/445
D387,580 S	*	12/1997	Walters, III et al.	D6/434
D404,590 S	*	1/1999	Tabbia	D6/445
D433,845 S	*	11/2000	Wilson et al.	D6/446
D451,303 S	*	12/2001	Lee	D6/446

* cited by examiner

Primary Examiner—Cathron C. Brooks

(74) *Attorney, Agent, or Firm*—Wood, Herron & Evans, L.L.P.

(57) **CLAIM**

The ornamental design for the dresser, as shown and described.

DESCRIPTION

FIG. 1 is a front elevational view of a dresser, incorporating the design of my invention, depicting the hinged leaf in its open position;

FIG. 2 is a right side elevational view thereof, showing the hinged leaf in its open, forwardly extending, horizontal position;

FIG. 3 is a rear elevational view thereof;

FIG. 4 is a left side elevational view thereof, showing the hinged leaf in its open, forwardly extending, horizontal position;

FIG. 5 is a top plan view thereof, showing the hinged leaf in its open, forwardly extending, horizontal position;

FIG. 6 is a bottom plan view thereof, showing the hinged leaf in its open, forwardly extending, horizontal position;

FIG. 7 is a horizontal, cross-sectional view along Line 7—7 of FIG. 1, depicting the concave front surface of the upper three drawers and the hinged leaf in its open, forwardly extending, horizontal position;

FIG. 8 is a horizontal, cross-sectional view along Line 8—8 of FIG. 1, depicting the generally planar front of the dresser below the hinged leaf;

FIG. 9 is a vertical, cross-sectional view along line 9—9 of FIG. 1, depicting the front surface of the dresser with the hinged leaf in its open, forwardly extending, horizontal position;

FIG. 10 is a horizontal, cross-sectional view similar to FIG. 7, depicting the hinged leaf in its closed position;

FIG. 11 is a vertical, cross-sectional view similar to FIG. 9, depicting the hinged leaf in its closed position;

FIG. 12 is a top plan view, similar to FIG. 5, depicting the hinged leaf in its closed position;

FIG. 13 is a left side elevational view, similar to FIG. 4, showing the hinged leaf in its closed position, the right side elevational view being a mirror image thereof; and,

FIG. 14 is a bottom plan view, similar to FIG. 6, depicting the hinged leaf in its closed position.

1 Claim, 11 Drawing Sheets

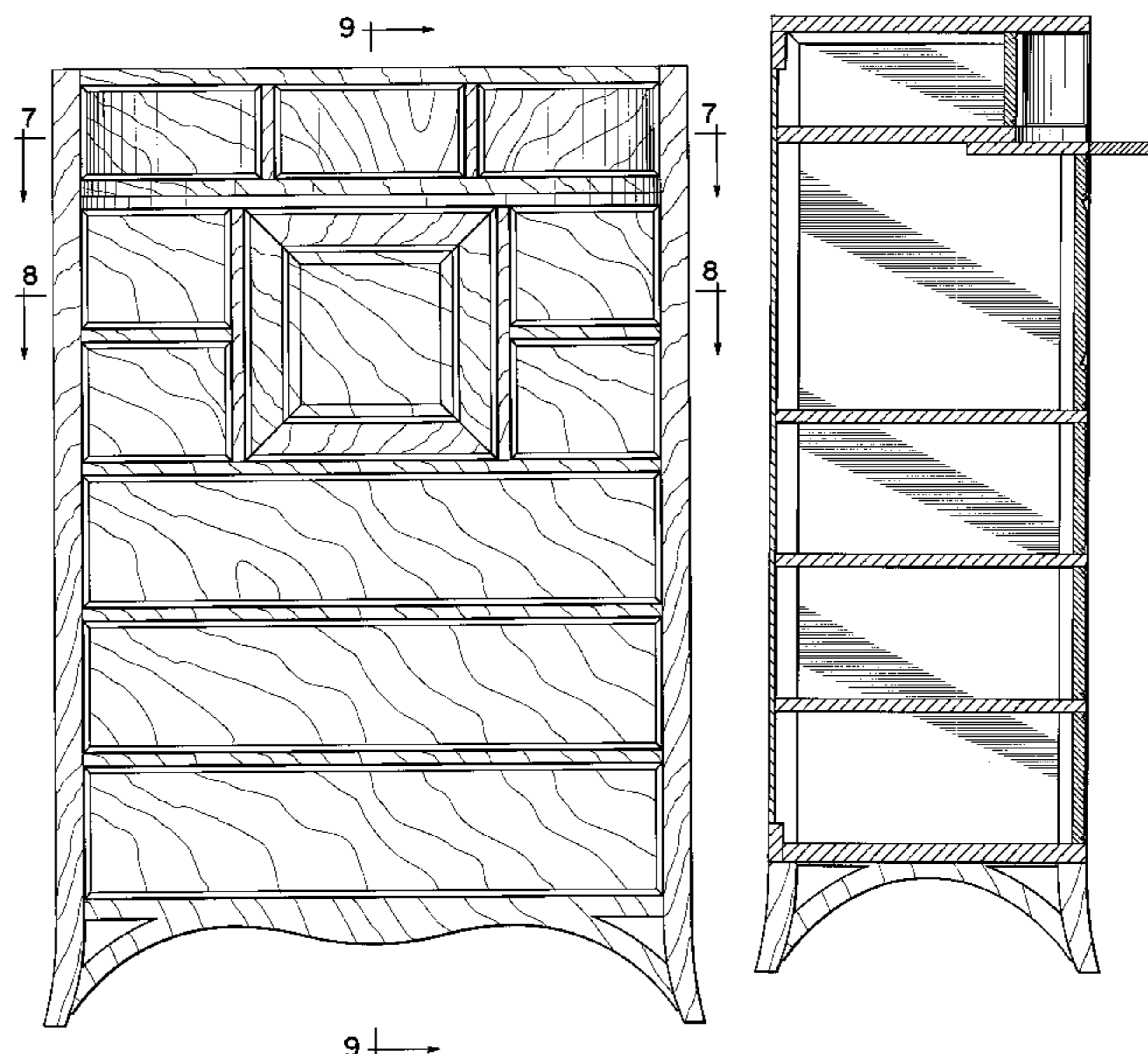

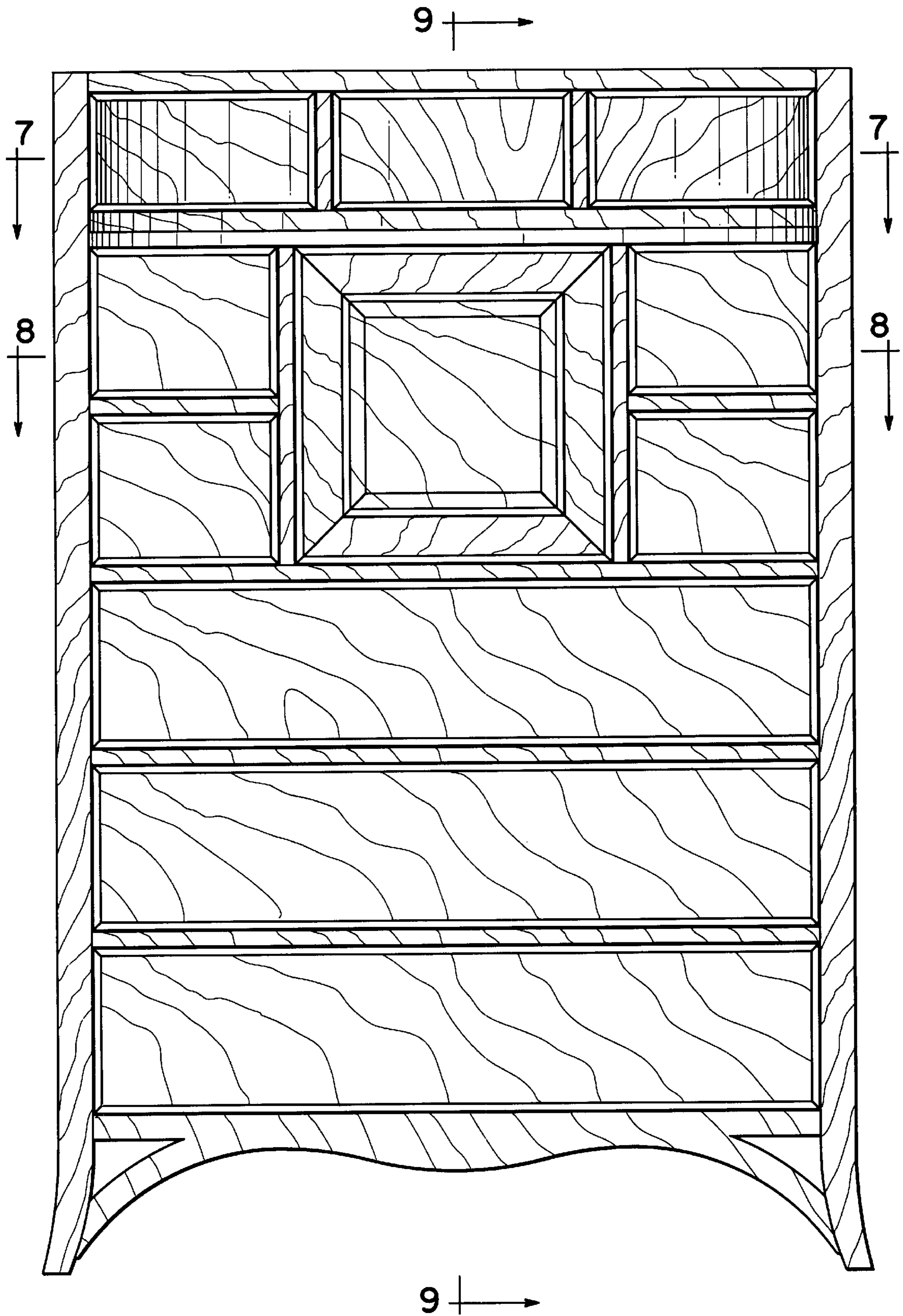

FIG. 1

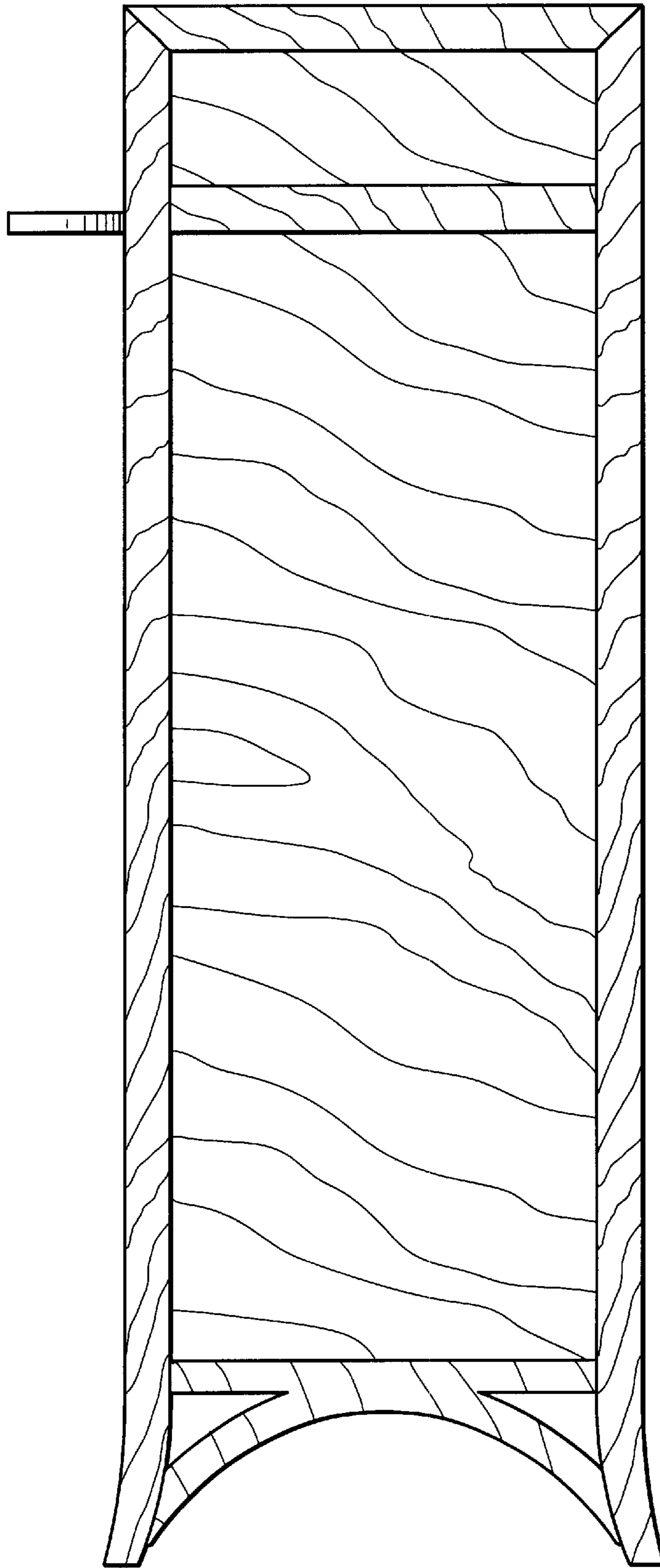

FIG. 2

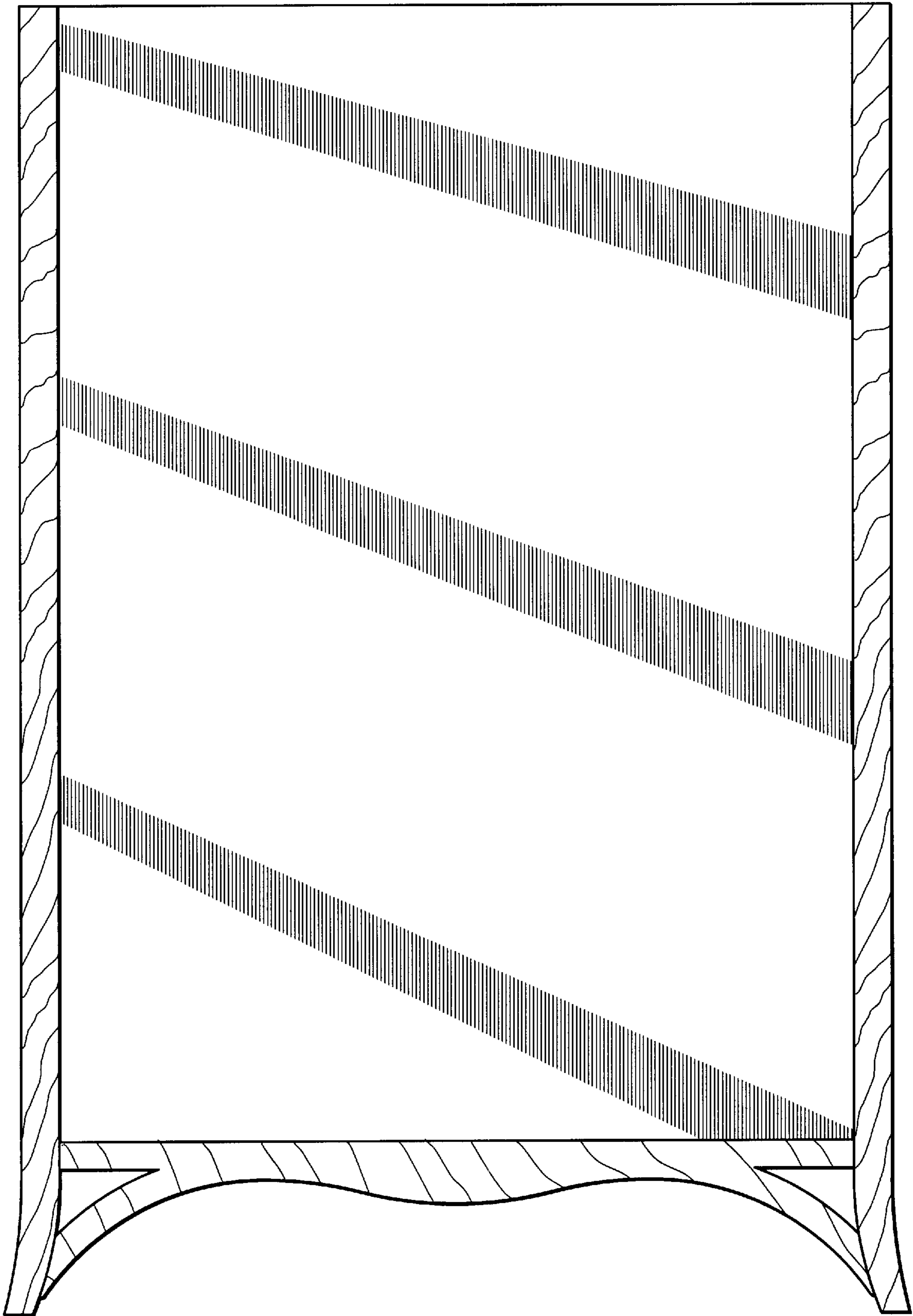

FIG. 3

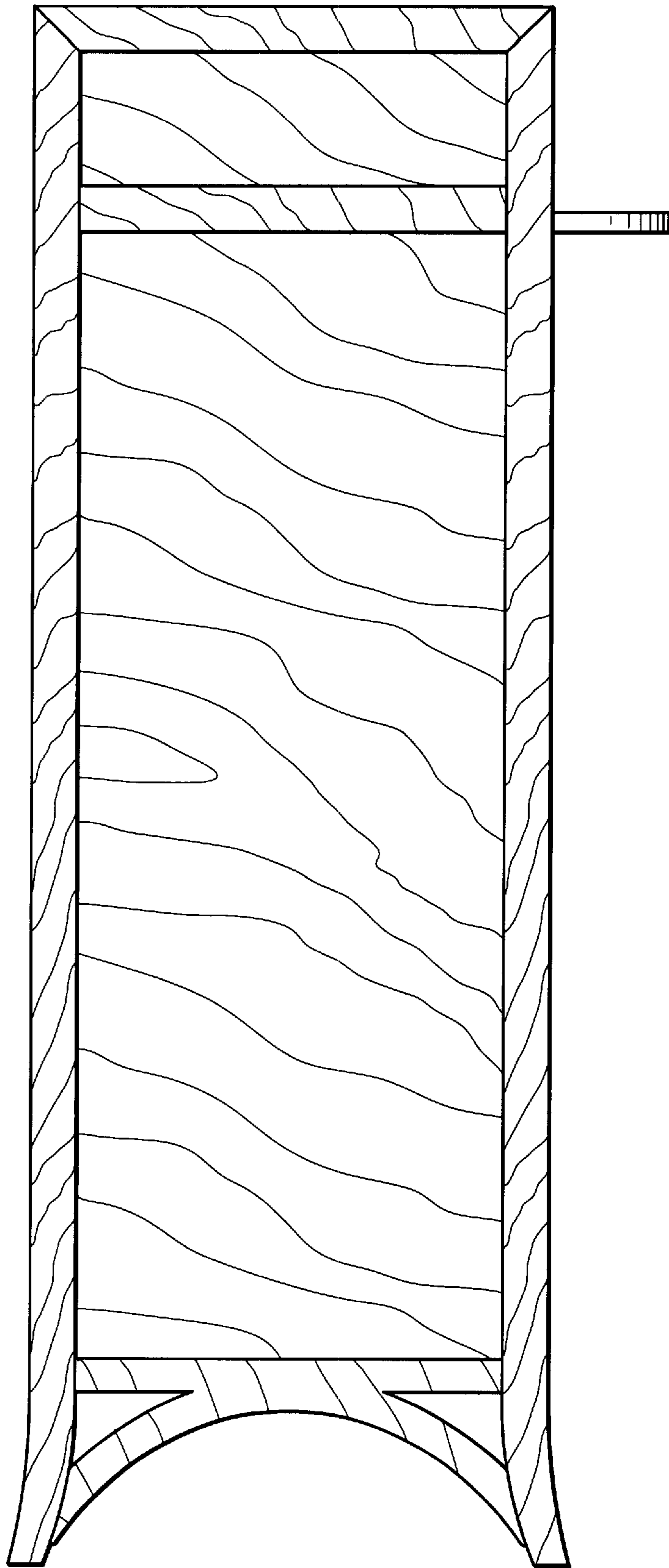

FIG. 4

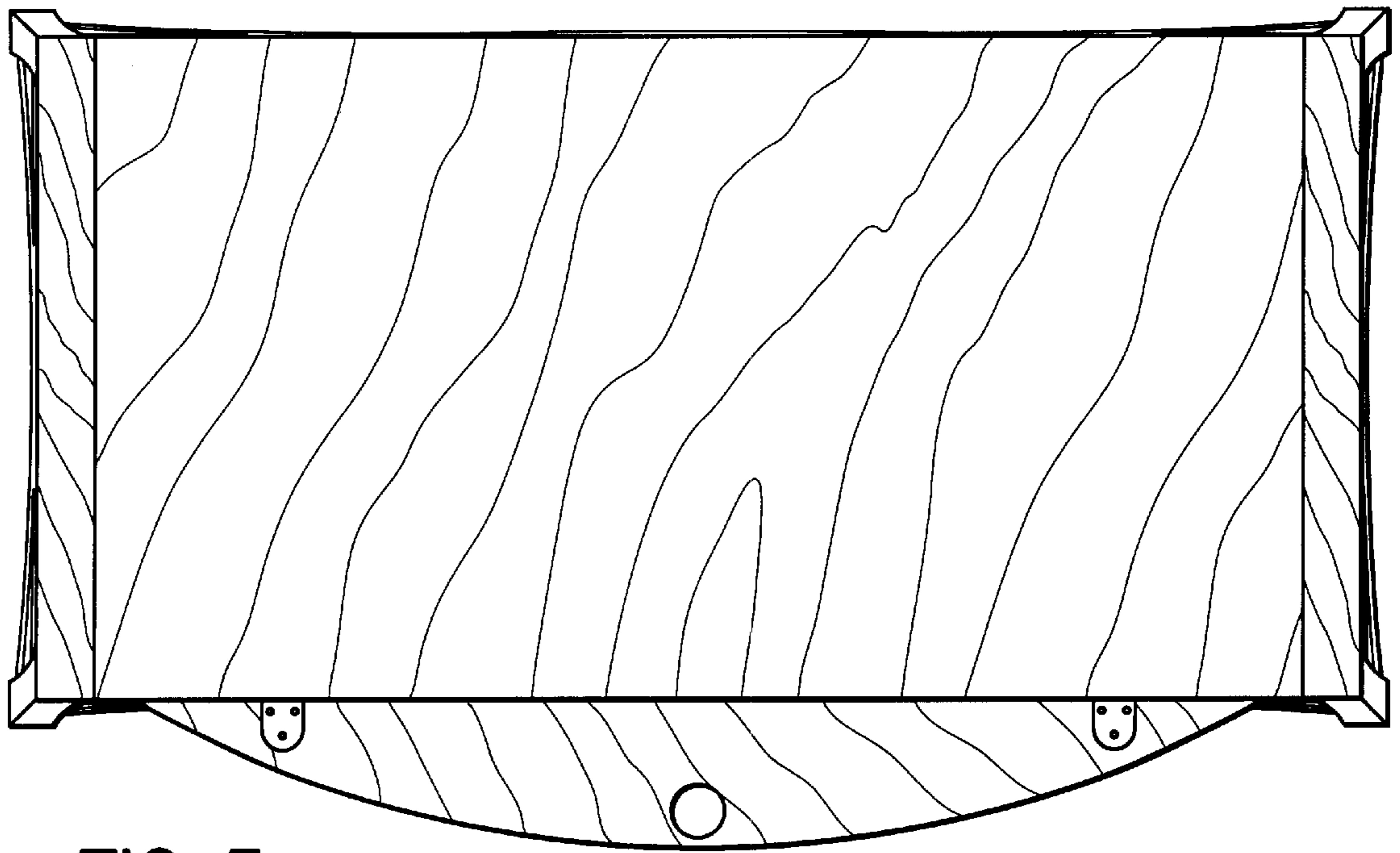

FIG. 5

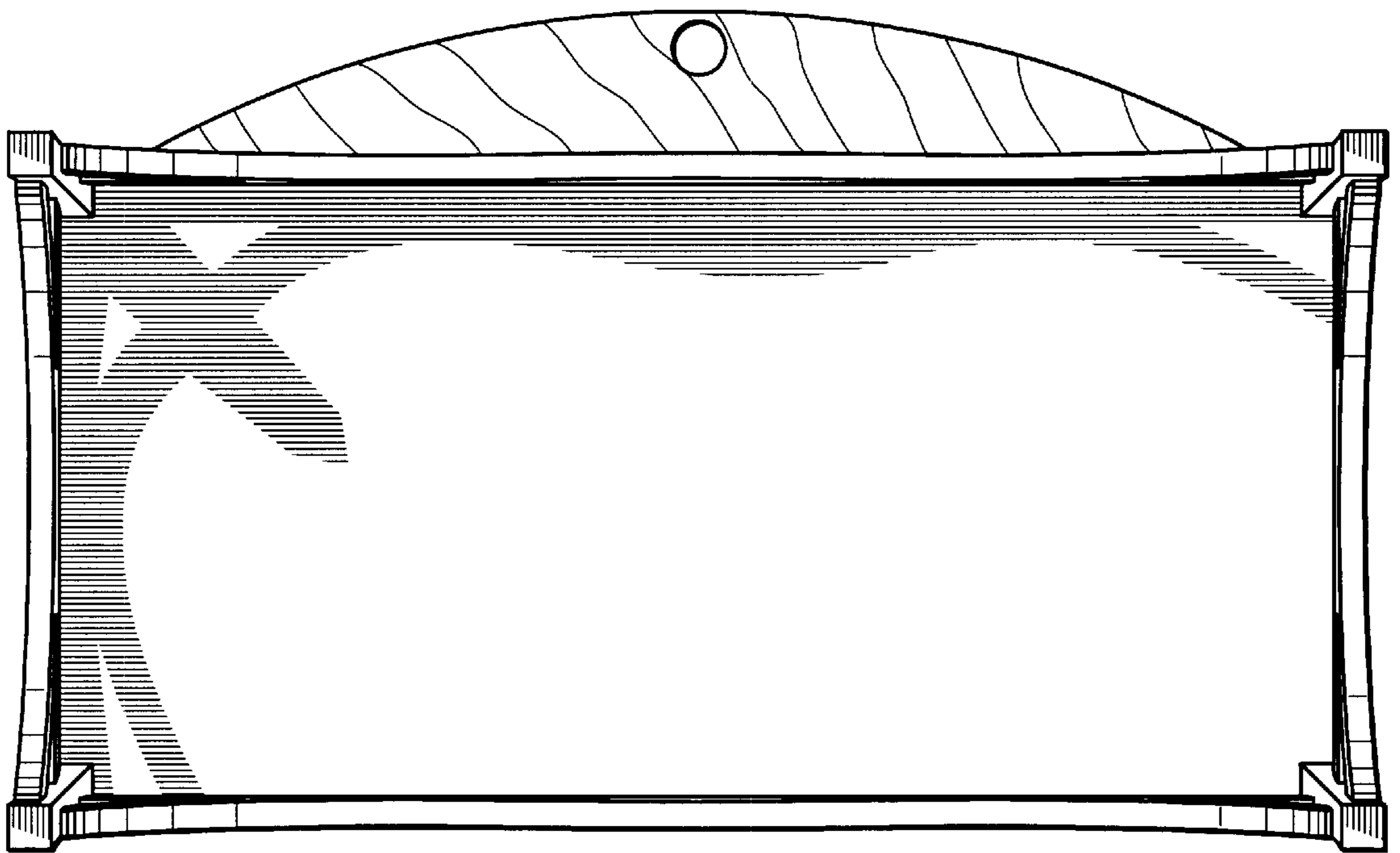

FIG. 6

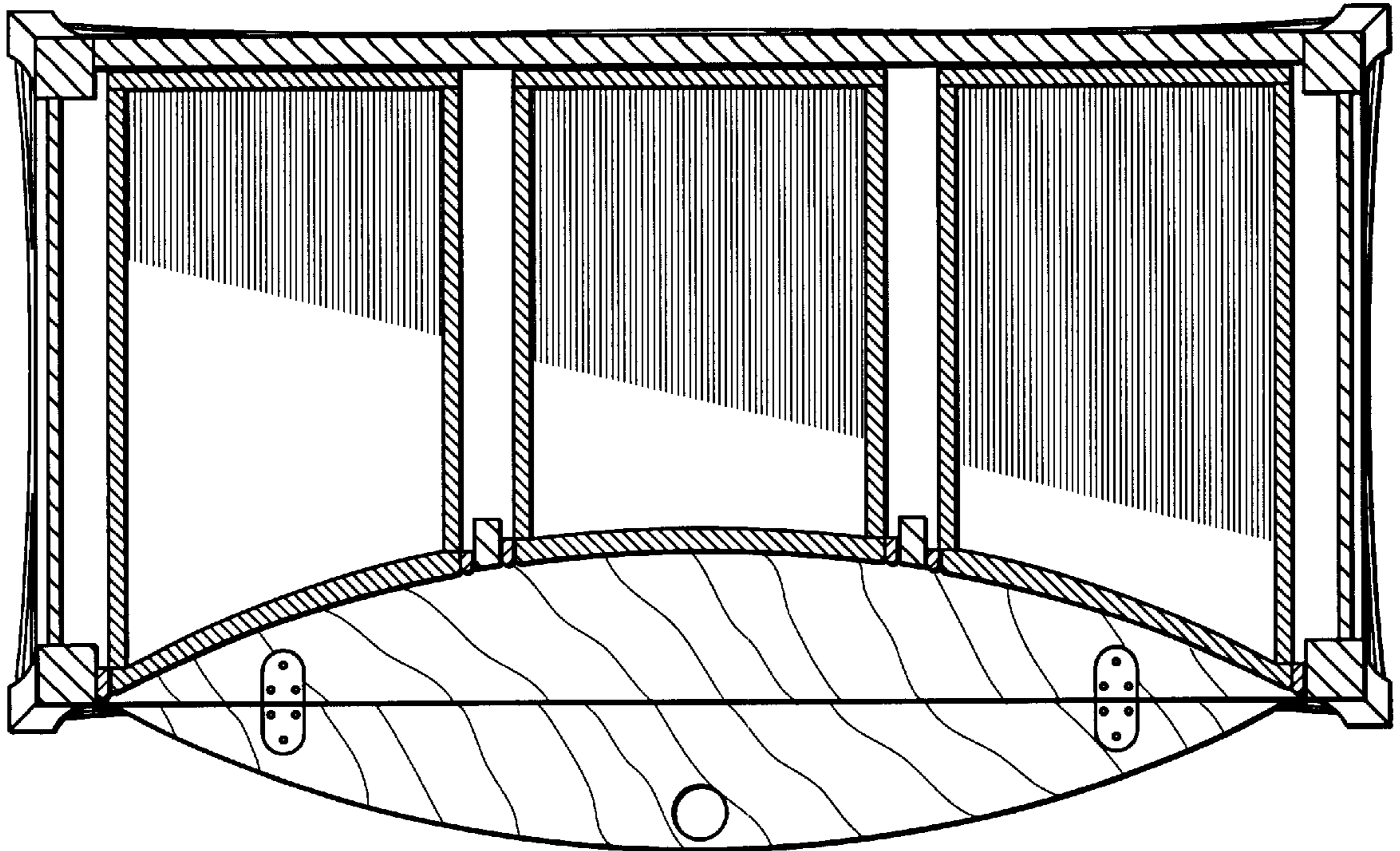

FIG. 7

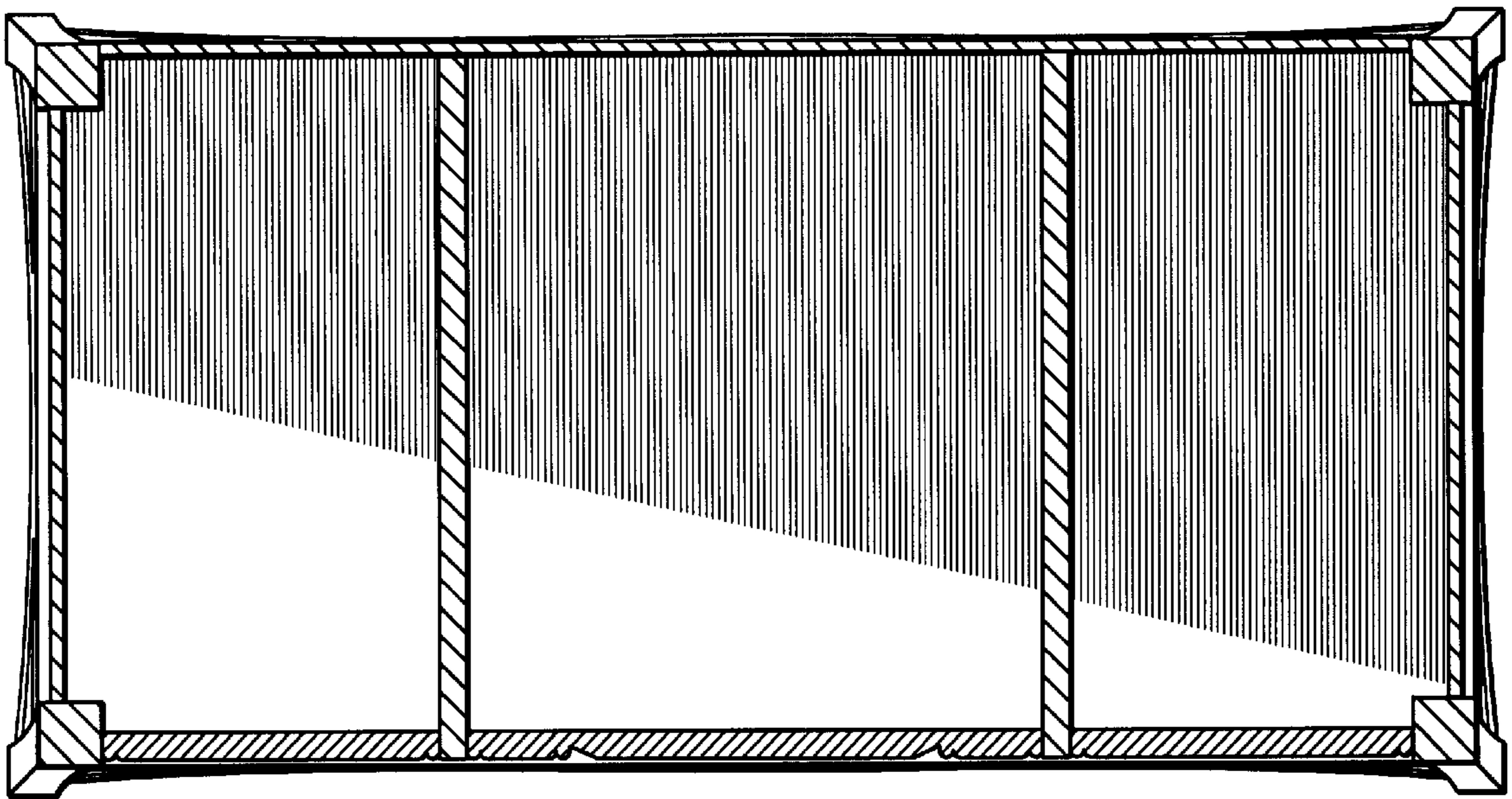

FIG. 8

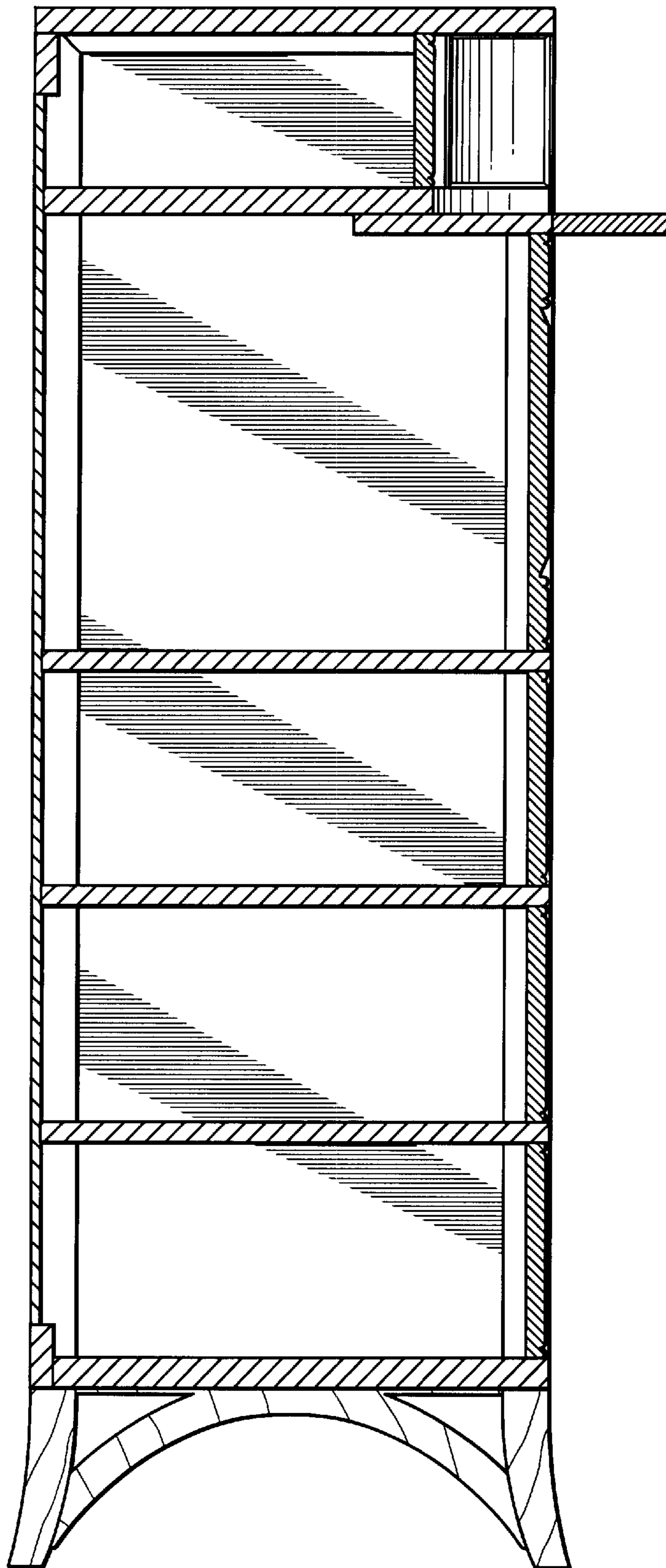

FIG. 9

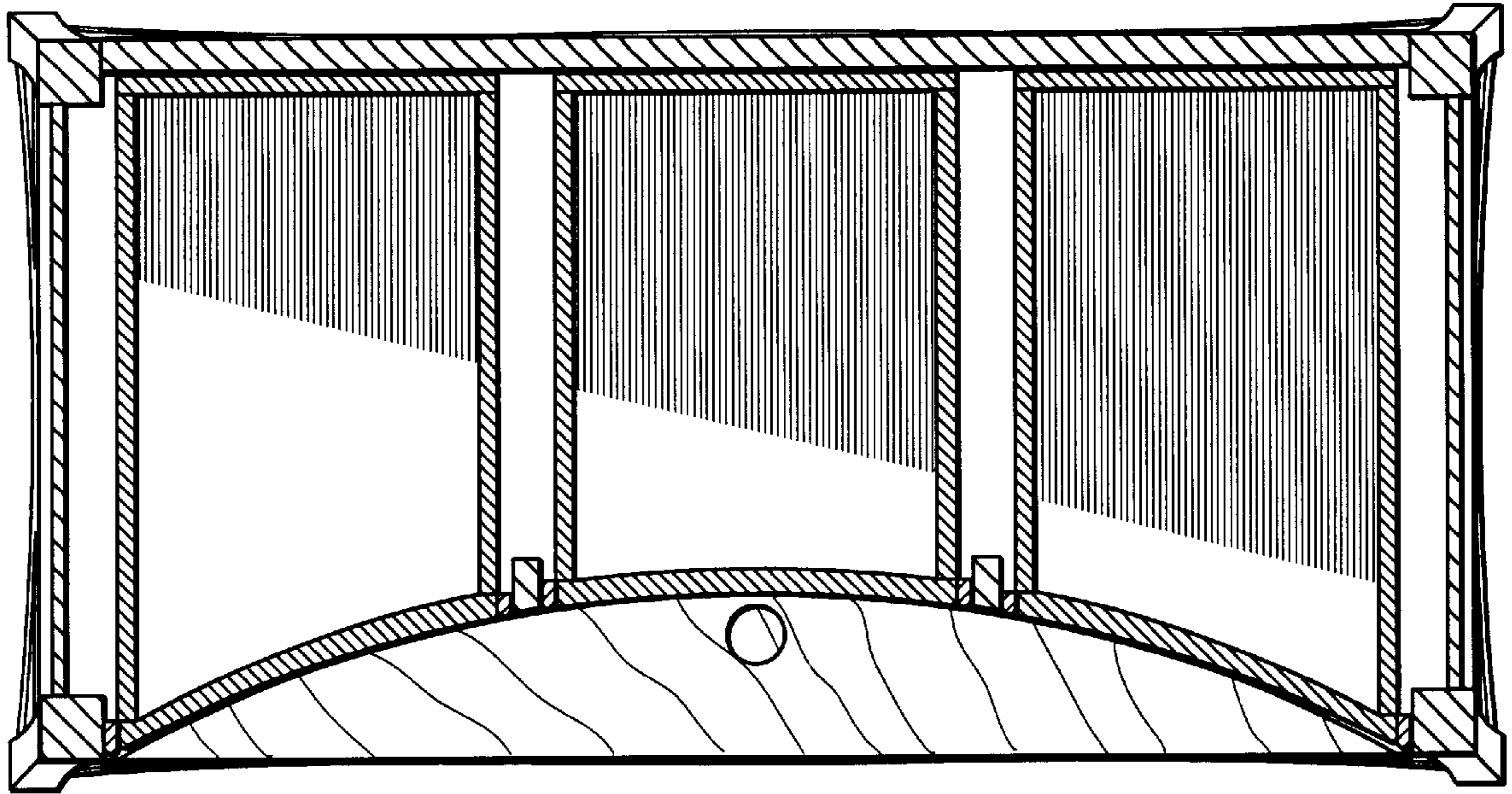

FIG. 10

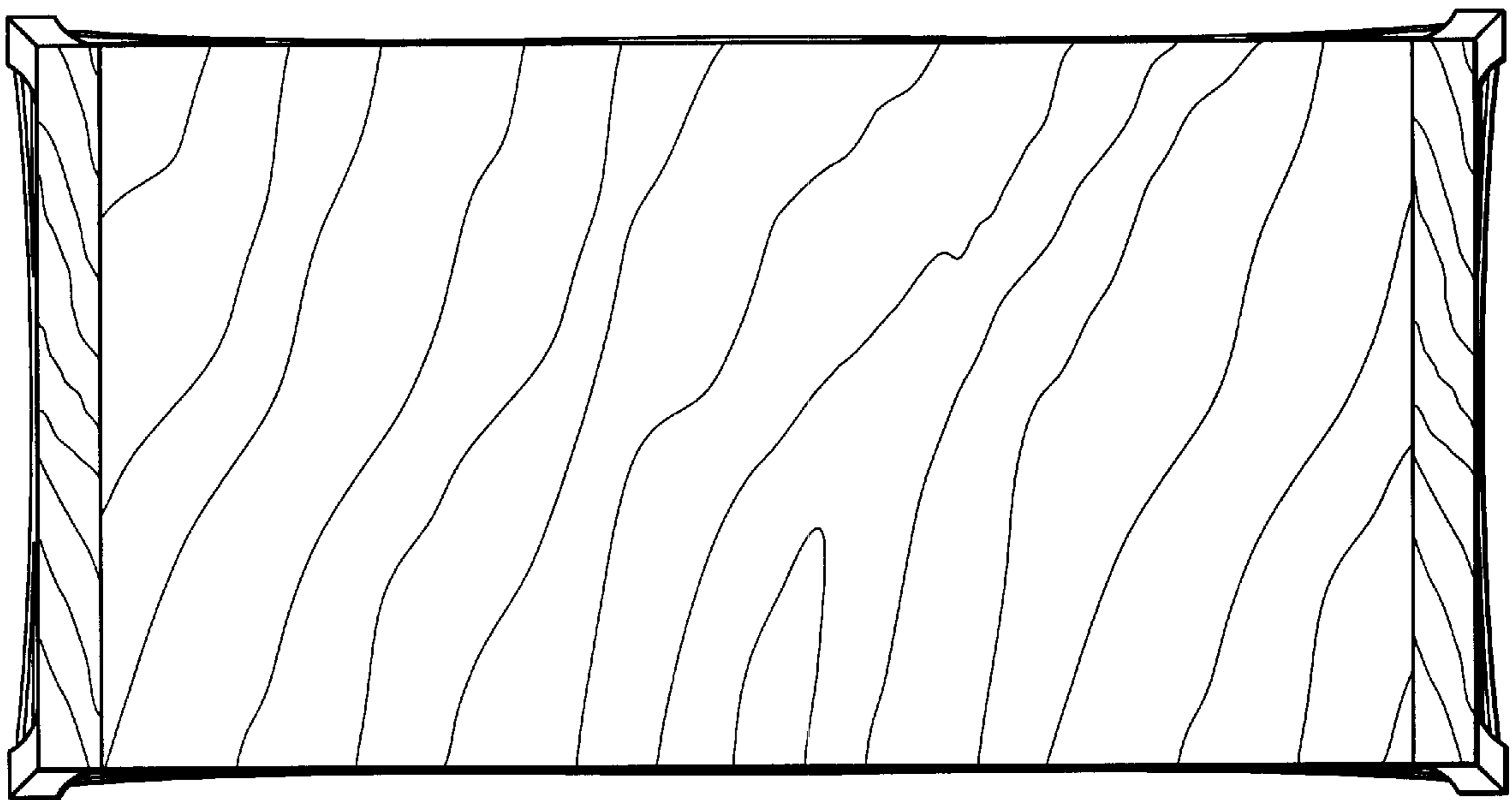

FIG. 12

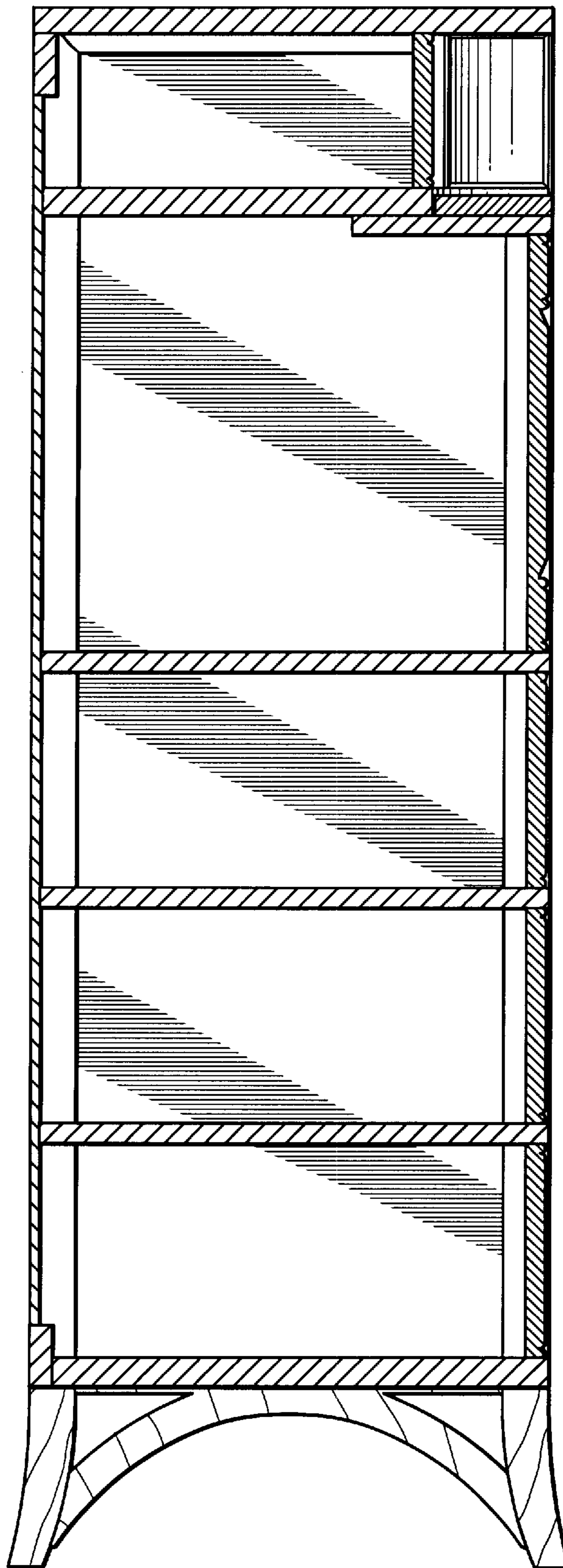

FIG. 11

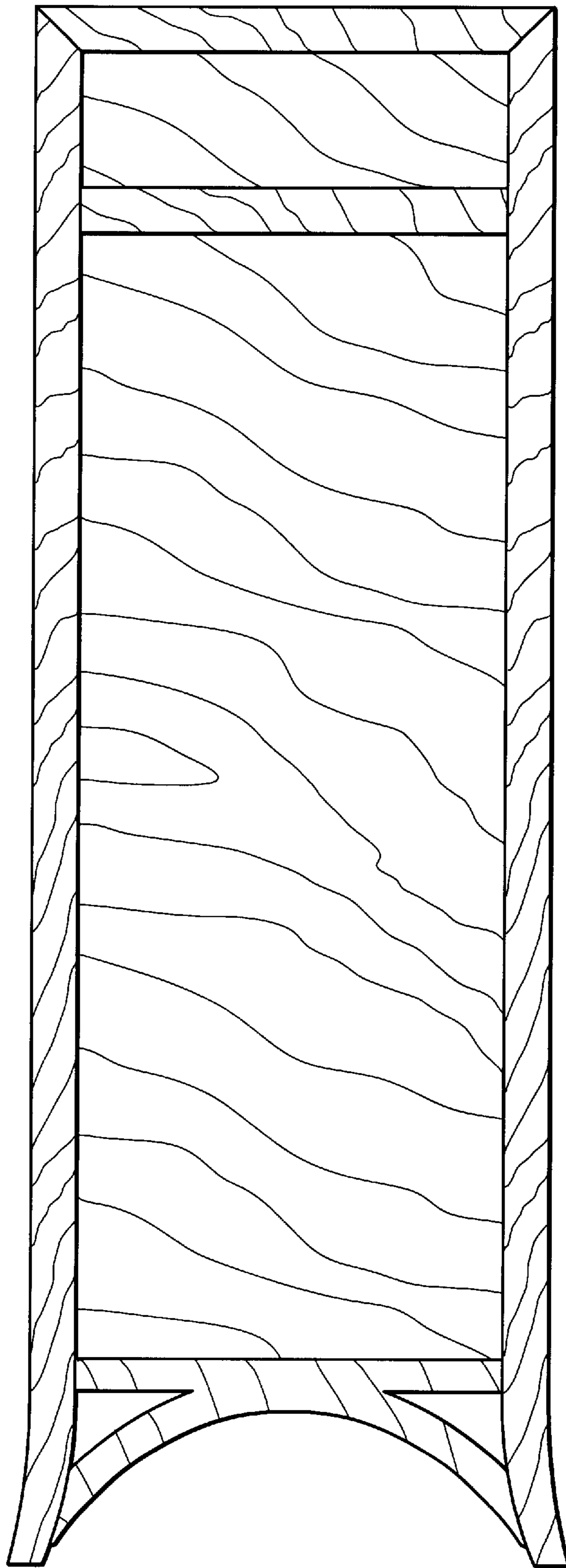

FIG. 13

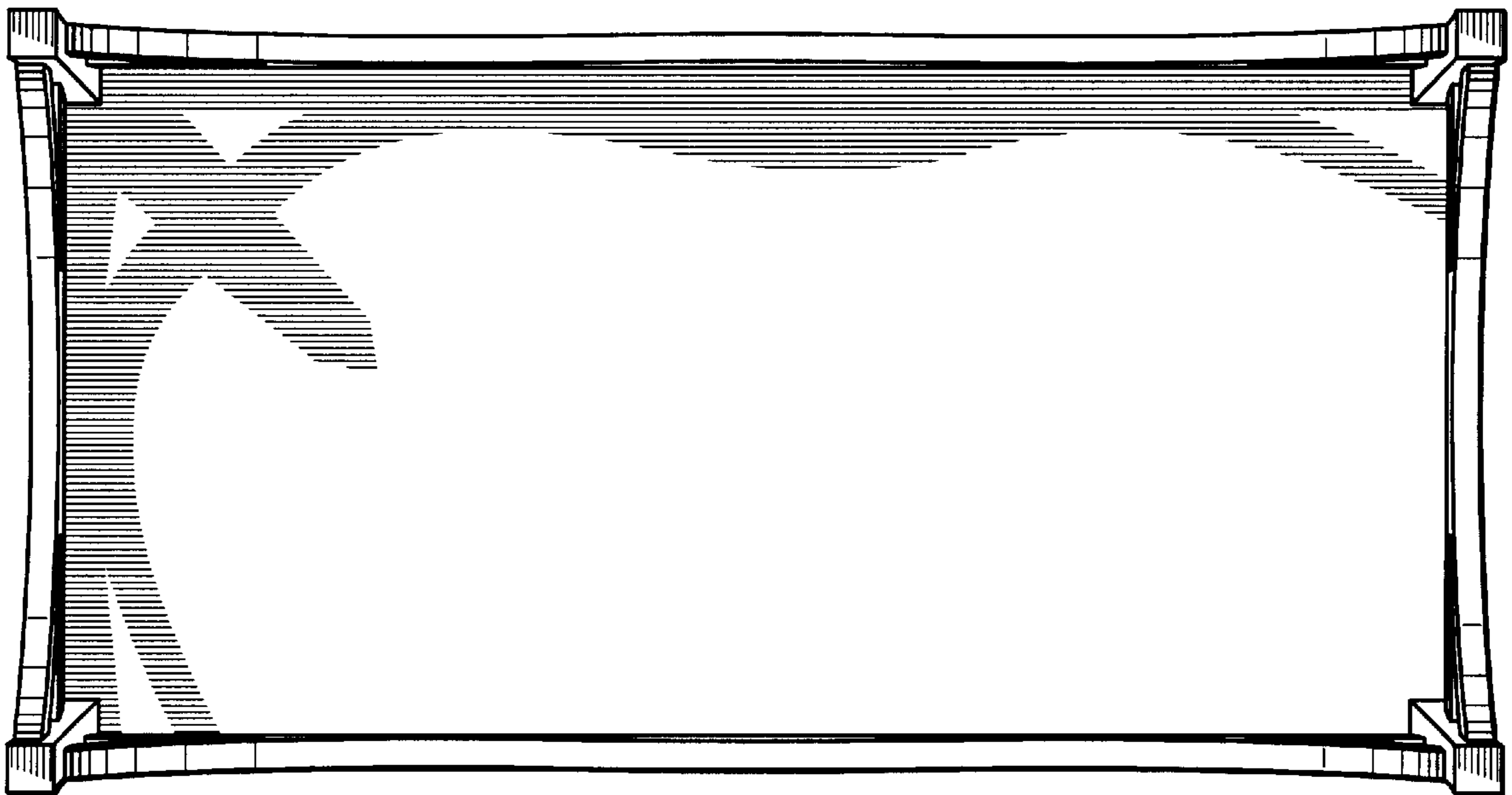

FIG. 14