



US00D462499S

(12) **United States Design Patent**
Erwin

(10) **Patent No.:** **US D462,499 S**

(45) **Date of Patent:** **** Sep. 3, 2002**

- (54) **MAILBOX POST ASSEMBLY**
- (75) Inventor: **Ronald D. Erwin**, Fayetteville, GA (US)
- (73) Assignee: **Erwin Industries, Inc.**, Peachtree City, GA (US)
- (**) Term: **14 Years**
- (21) Appl. No.: **29/148,285**
- (22) Filed: **Sep. 18, 2001**
- (51) **LOC (7) Cl.** **99-00**
- (52) **U.S. Cl.** **D99/32**
- (58) **Field of Search** D99/29, 30, 31, D99/32, 43; 232/17, 39; 52/721.2

- 5,022,618 A 6/1991 Barrett et al.
- 5,119,986 A 6/1992 Kobilarcik et al.
- D334,272 S 3/1993 Gaines
- D338,762 S 8/1993 Nichols
- 5,356,072 A 10/1994 Thomas
- D378,462 S 3/1997 Erwin
- 5,620,136 A 4/1997 Erwin
- D393,532 S * 4/1998 Black et al. D99/43
- 5,806,758 A 9/1998 Erwin

* cited by examiner

Primary Examiner—Paula A. Mortimer
(74) *Attorney, Agent, or Firm*—Gardner Groff & Mehrman, P.C.

(57) **CLAIM**

I claim the ornamental design for an mailbox post assembly, as shown and described.

(56) **References Cited**

U.S. PATENT DOCUMENTS

- 816,171 A * 3/1906 Inarra 52/721.2
- 1,590,725 A 1/1926 Coates
- D70,163 S 5/1926 Dobbins
- D172,997 S 9/1954 Stallings
- D182,607 S 4/1958 Loewenstein
- D194,895 S 3/1963 Bardos
- D197,683 S 3/1964 Kusel
- D199,107 S 9/1964 Kusel
- D200,748 S 3/1965 Taylor
- D220,458 S * 4/1971 Notes D99/32
- 3,957,250 A 5/1976 Murphy
- D254,755 S 4/1980 Mortensen et al.
- 4,509,675 A 4/1985 Siff et al.
- 4,588,123 A 5/1986 Plew
- 4,602,765 A 7/1986 Loper et al.
- D291,937 S 9/1987 Fisher
- 4,709,853 A 12/1987 Hahn
- 4,858,891 A 8/1989 Boes

DESCRIPTION

FIG. 1 is a perspective illustration of an mailbox post assembly according to a preferred form of the invention; FIG. 2 is a left side elevation view of the mailbox post assembly of FIG. 1; FIG. 3 is a rear view of the mailbox post assembly of FIG. 1; FIG. 4 is a right side elevation view of the mailbox post assembly of FIG. 1; FIG. 5 is a front view of the mailbox post assembly of FIG. 1; FIG. 6 is an exploded side perspective view of the mailbox post assembly shown in an alternate stored position for purposes of illustration; and, FIG. 7 is a bottom plan view of the mailbox post assembly with the cap removed for ease of illustration.

1 Claim, 4 Drawing Sheets

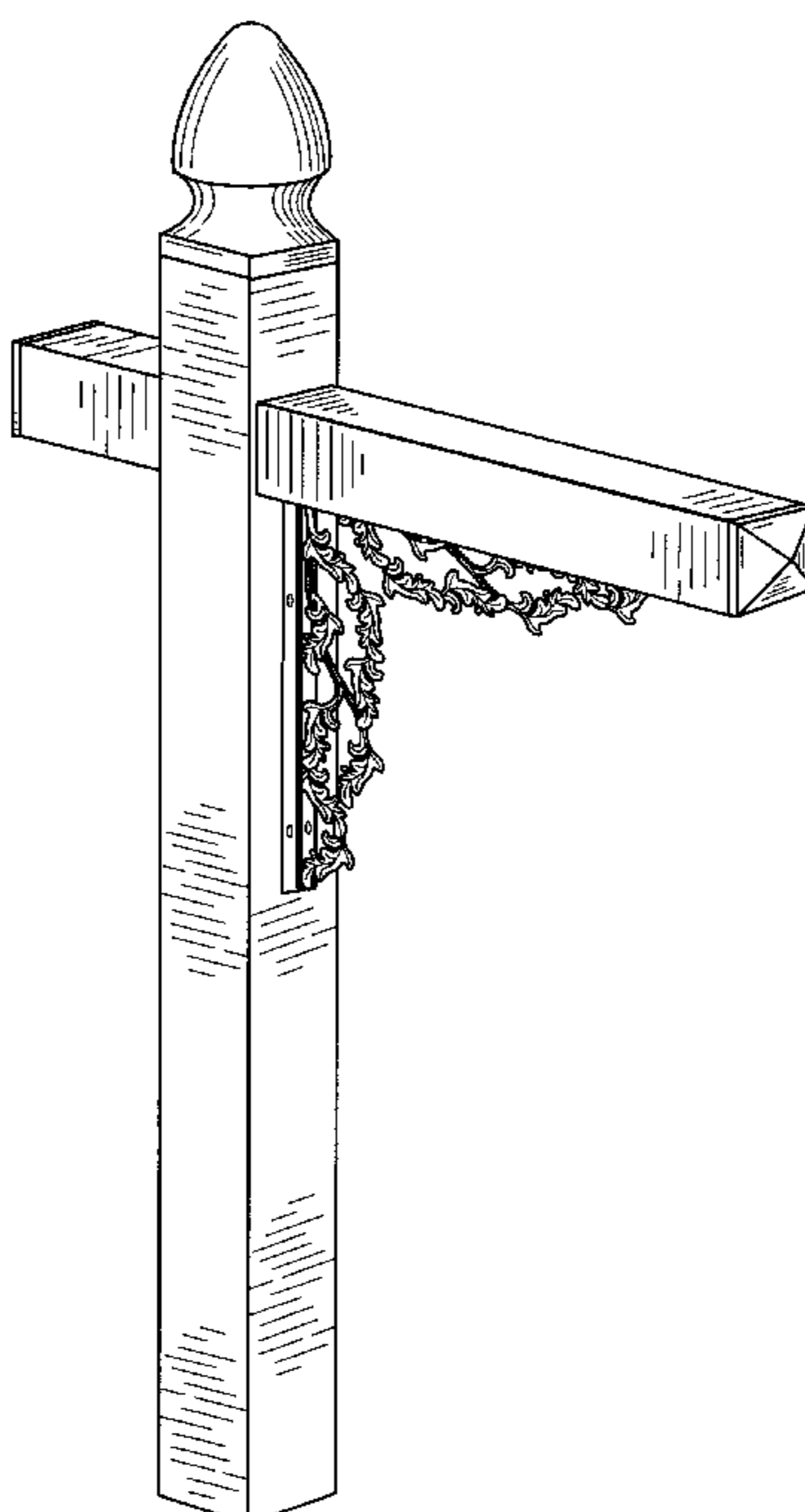

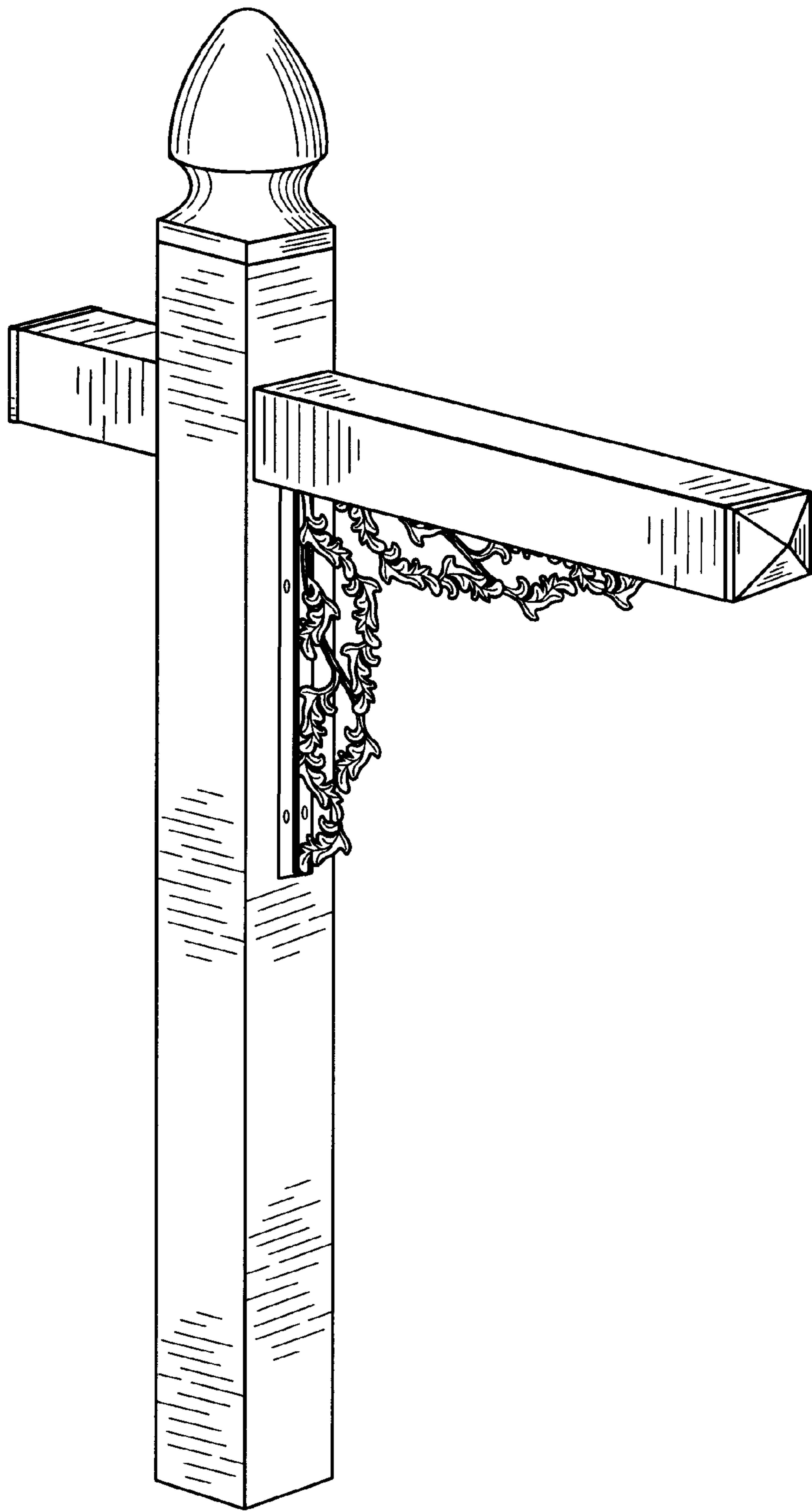

FIG. 1

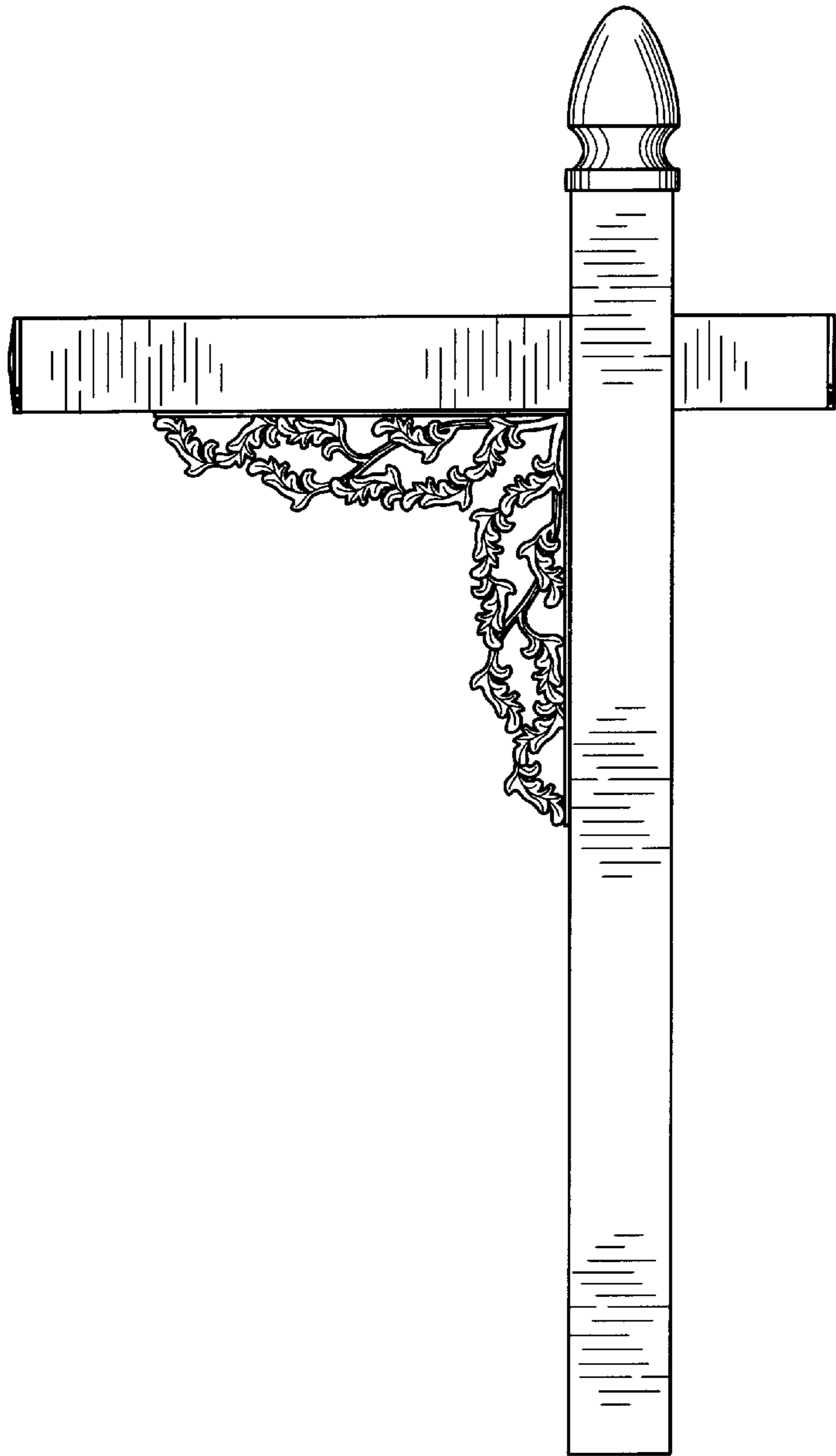

FIG. 2

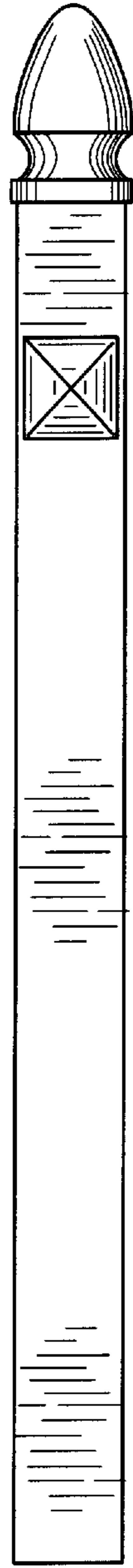

FIG. 3

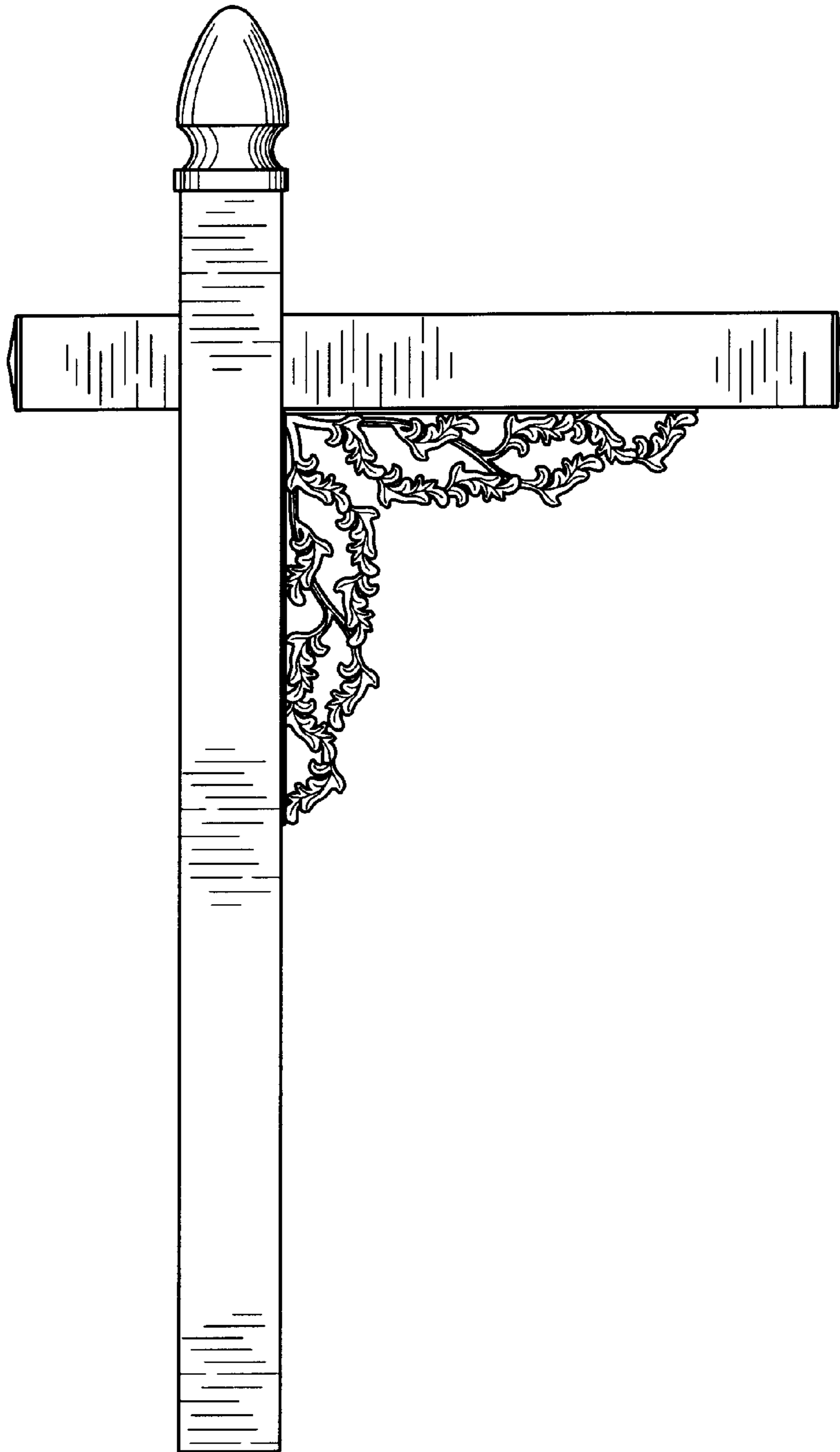

FIG. 4



FIG. 5

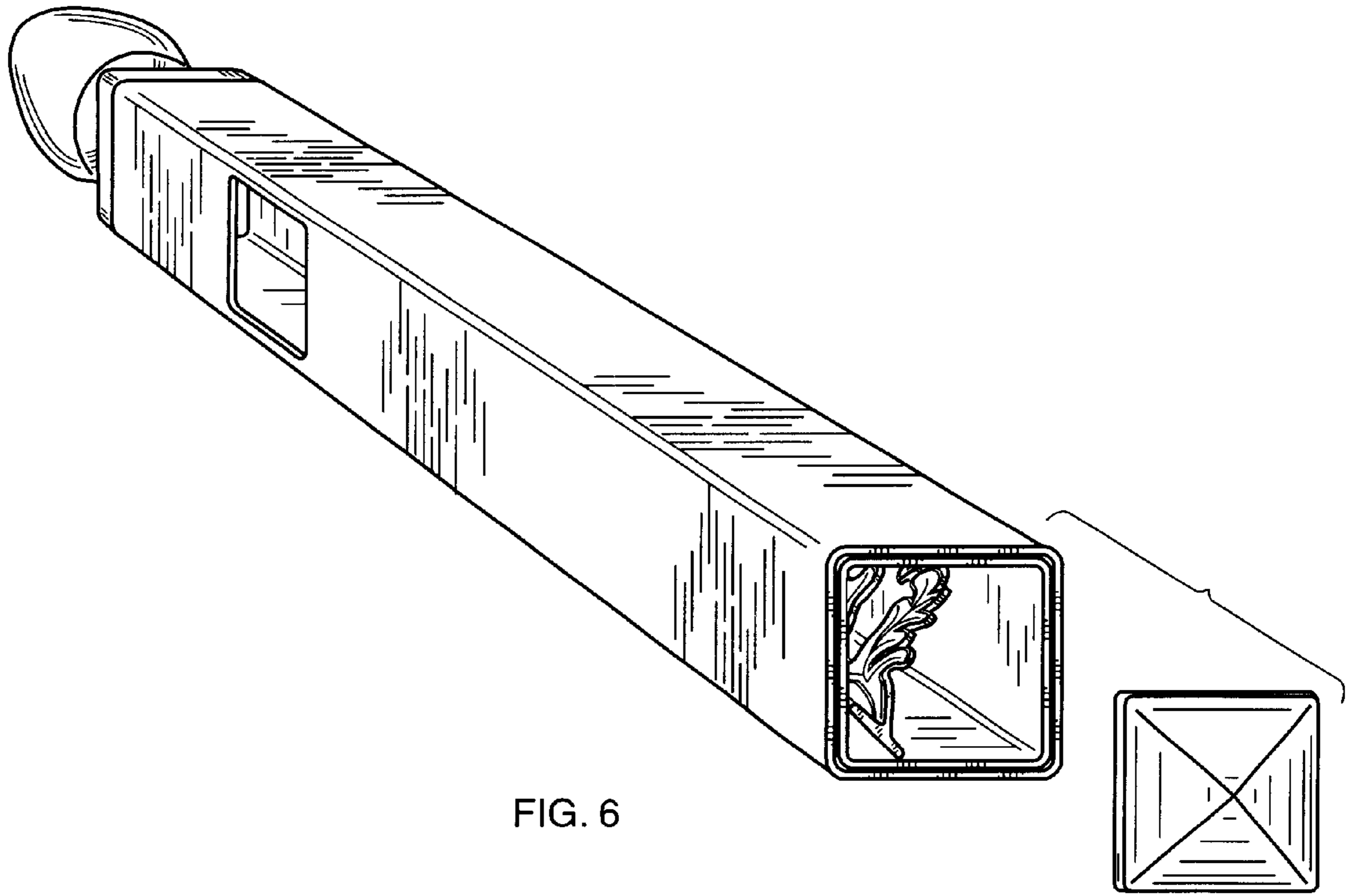

FIG. 6

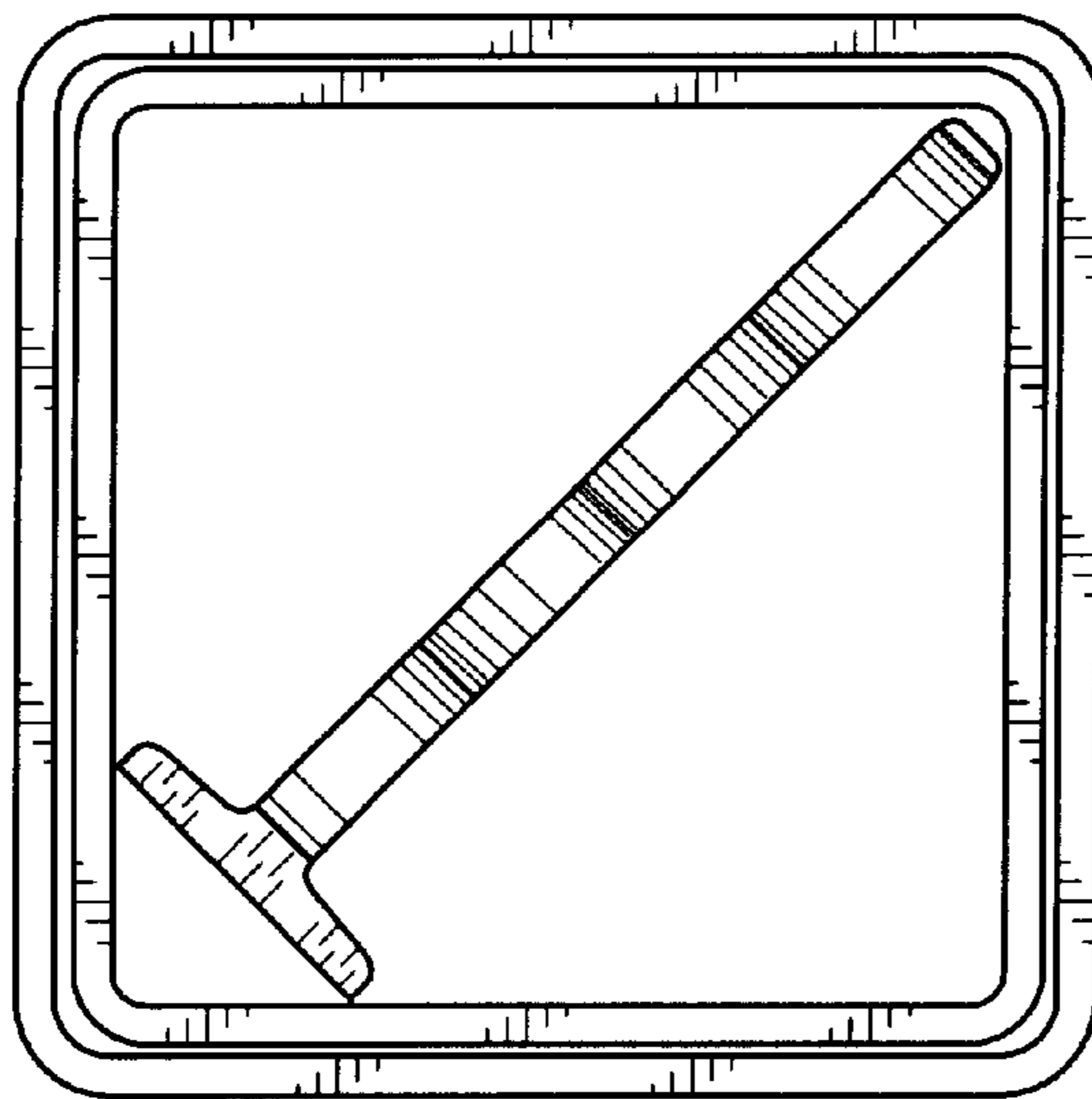

FIG. 7