



US00D462464S

(12) **United States Design Patent** (10) **Patent No.:** **US D462,464 S**
Yeh (45) **Date of Patent:** **** Sep. 3, 2002**

(54) **FLUORESCENT LIGHT BULB**

(74) *Attorney, Agent, or Firm*—Intellepharm, Inc.; Manfred E. Wolff

(76) **Inventor:** **John Yeh**, 800 Iowa Ave., Riverside, CA (US) 92507

(57) **CLAIM**

(**) **Term:** **14 Years**

I claim the ornamental design for the fluorescent light bulb, as shown and described.

(21) **Appl. No.:** **29/145,565**

DESCRIPTION

(22) **Filed:** **Jul. 24, 2001**

(51) **LOC (7) Cl.** **26-06**

FIG. 1 is a front and top perspective view of a fluorescent light bulb showing my new design in full lines with the broken line showing of environmental association matter being for illustrative purposes only and forming no part of the claimed design;

(52) **U.S. Cl.** **D26/3**

(58) **Field of Search** D26/1, 2, 3, 26; 313/110, 313, 315, 317, 318, 491, 493, 567, 568; 315/56, 57, 58, 73

FIG. 2 is a front elevational view thereof shown in full lines, and the environmental matter shown in broken lines;

(56) **References Cited**

U.S. PATENT DOCUMENTS

D432,686 S	*	10/2000	Camarota et al.	D26/3
D447,580 S	*	9/2001	Kim	D26/3
D448,502 S	*	9/2001	Choi	D26/3

FIG. 3 is a right side elevational view thereof shown in full lines, and the environmental matter shown in broken lines;

FIG. 4 is a top plan view thereof;

FIG. 5 is a left side elevational view thereof shown in full lines, and the environmental matter shown in broken lines;

FIG. 6 is a rear elevational view thereof shown in full lines, and the environmental matter shown in broken lines; and,

FIG. 7 is a bottom plan view thereof.

* cited by examiner

Primary Examiner—Marcus A. Jackson

1 Claim, 2 Drawing Sheets

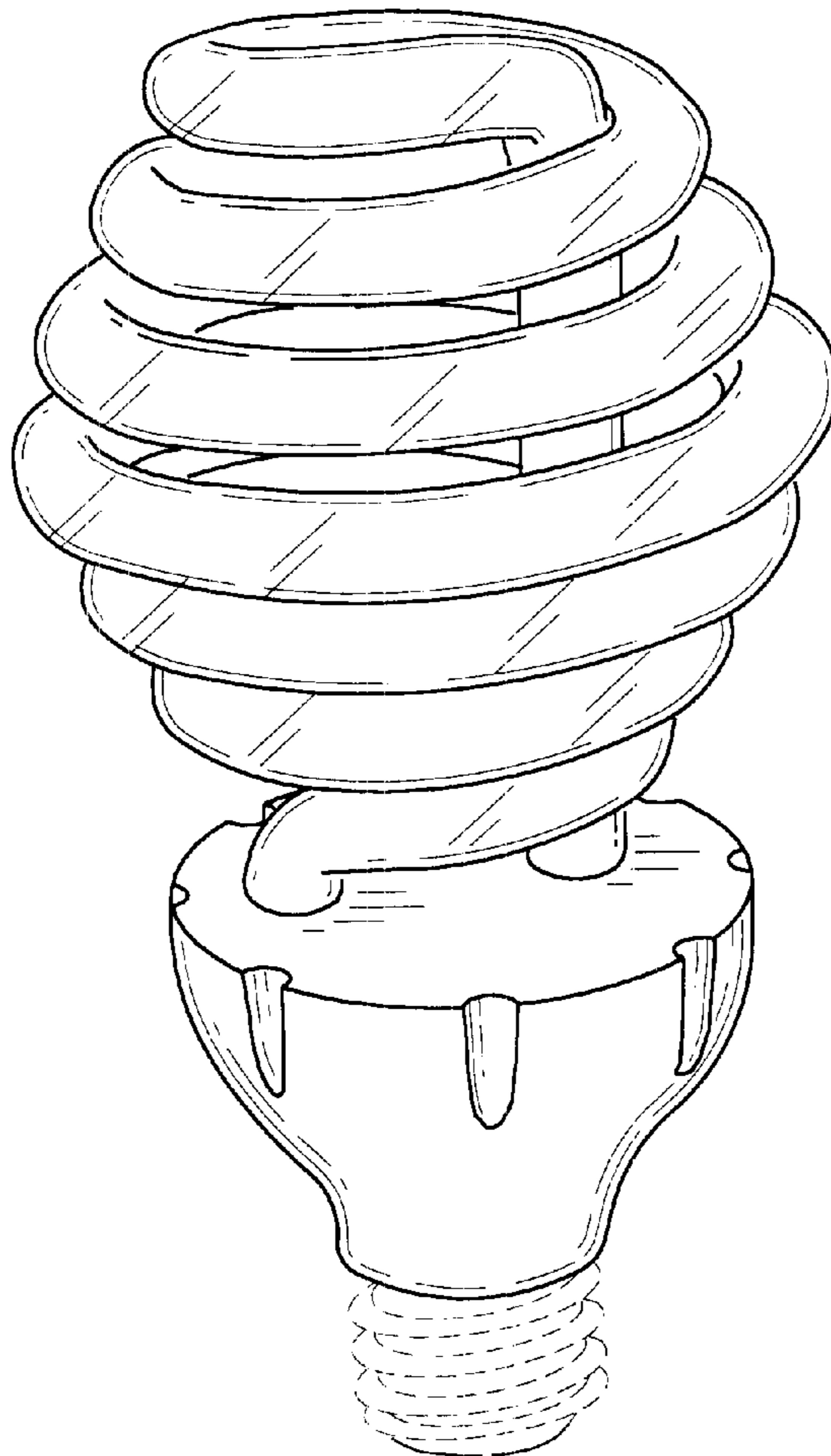

Fig. 1

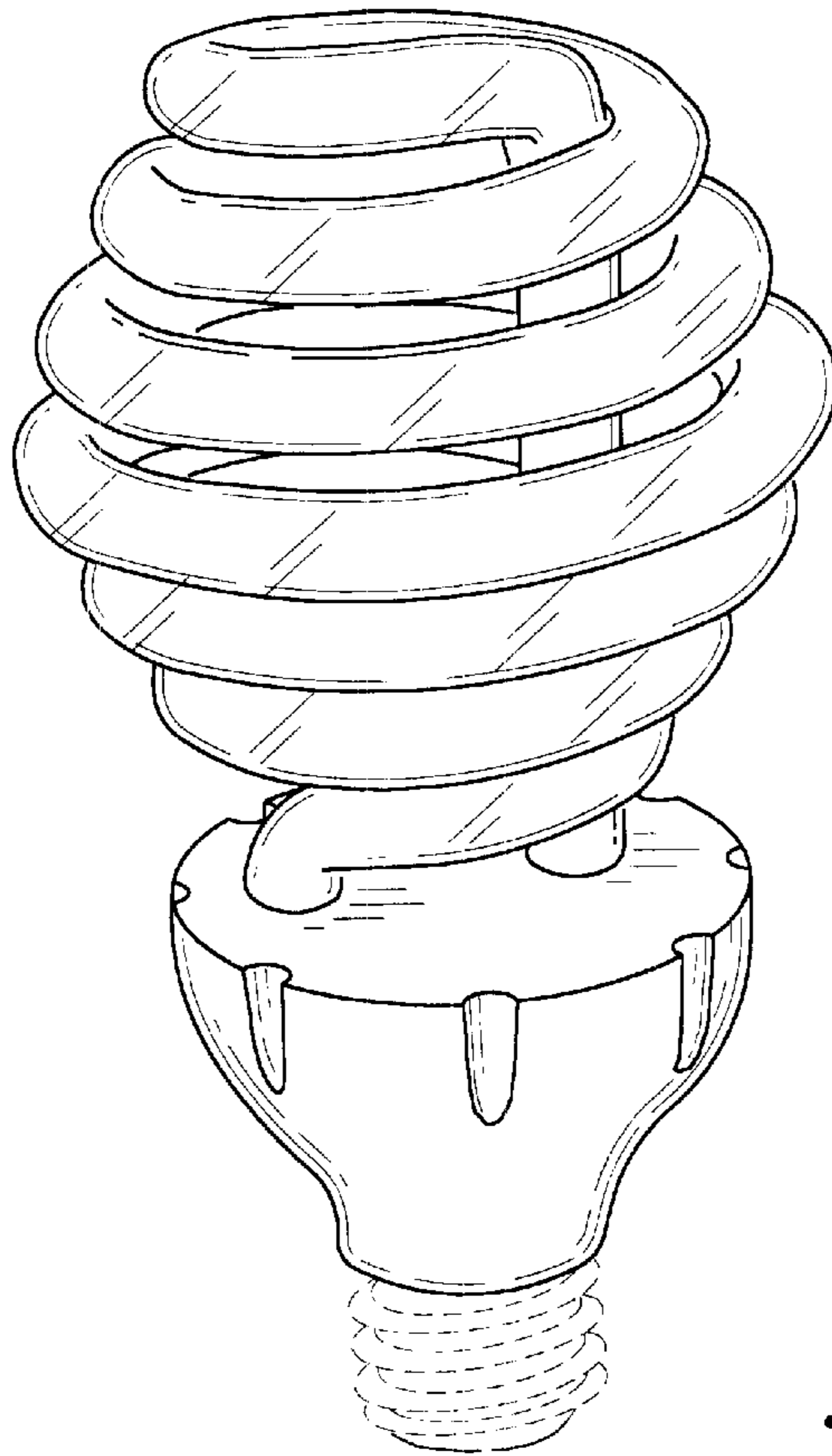

Fig. 2

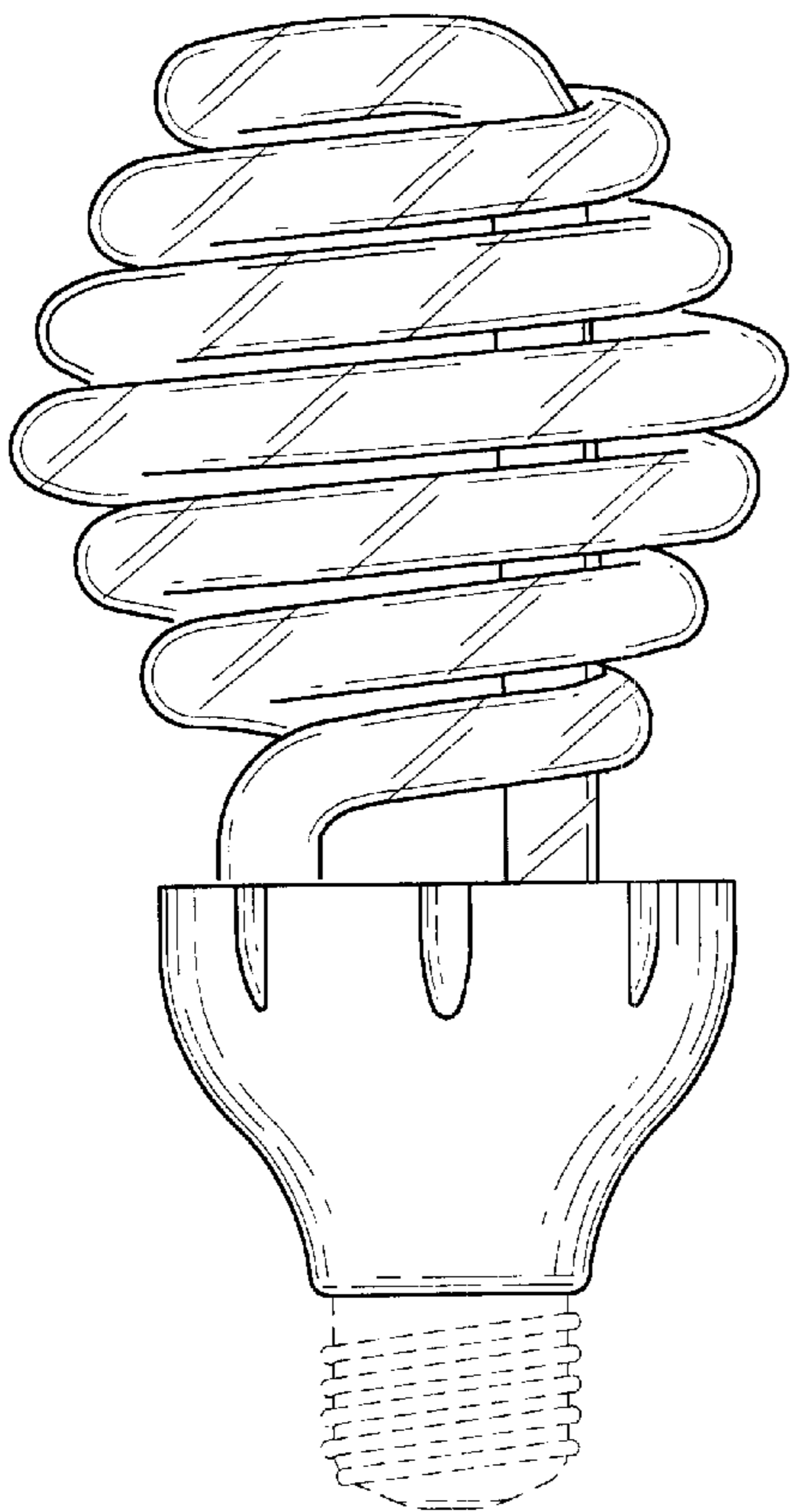

Fig. 3

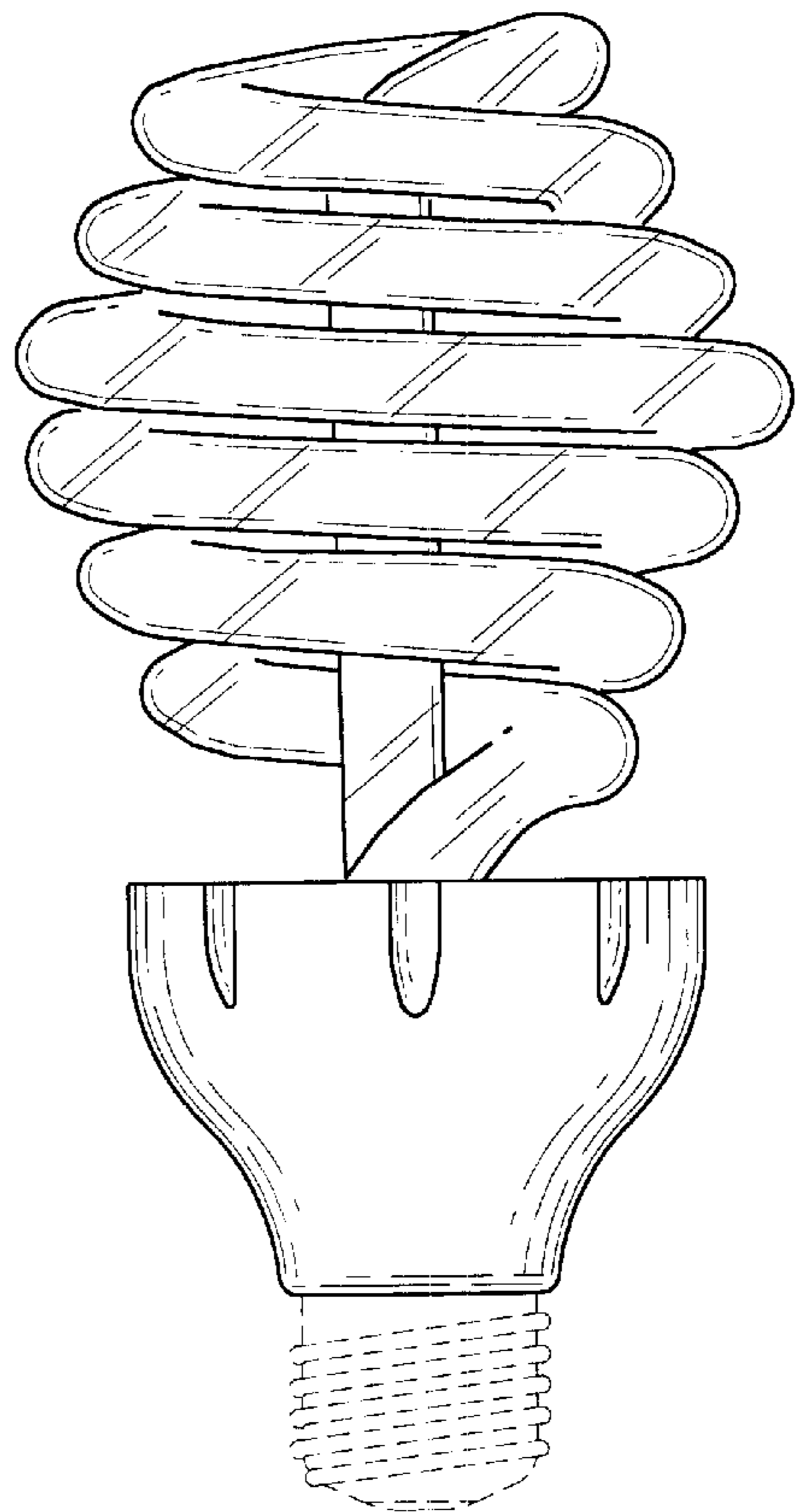

Fig. 4

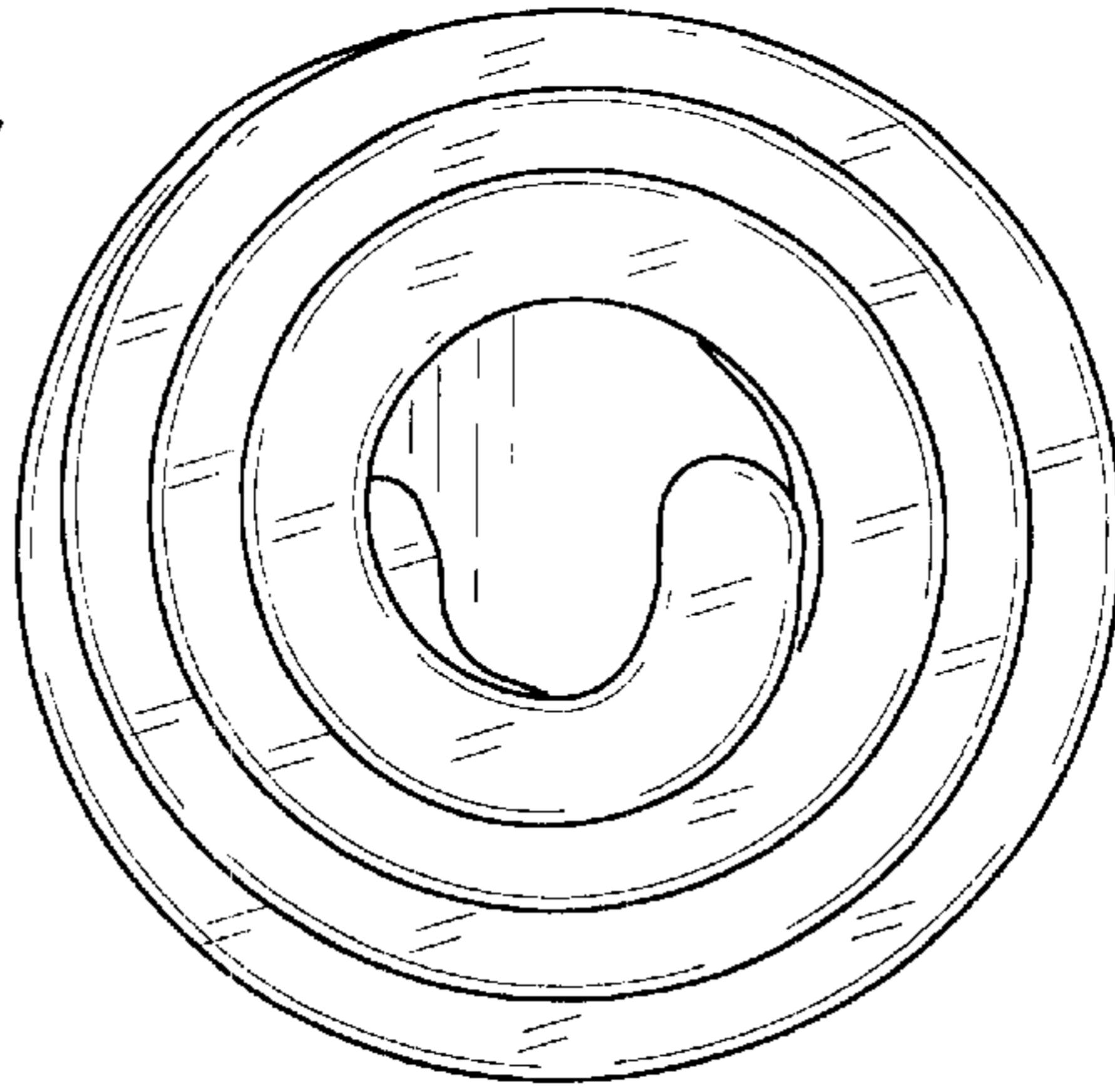

Fig. 5

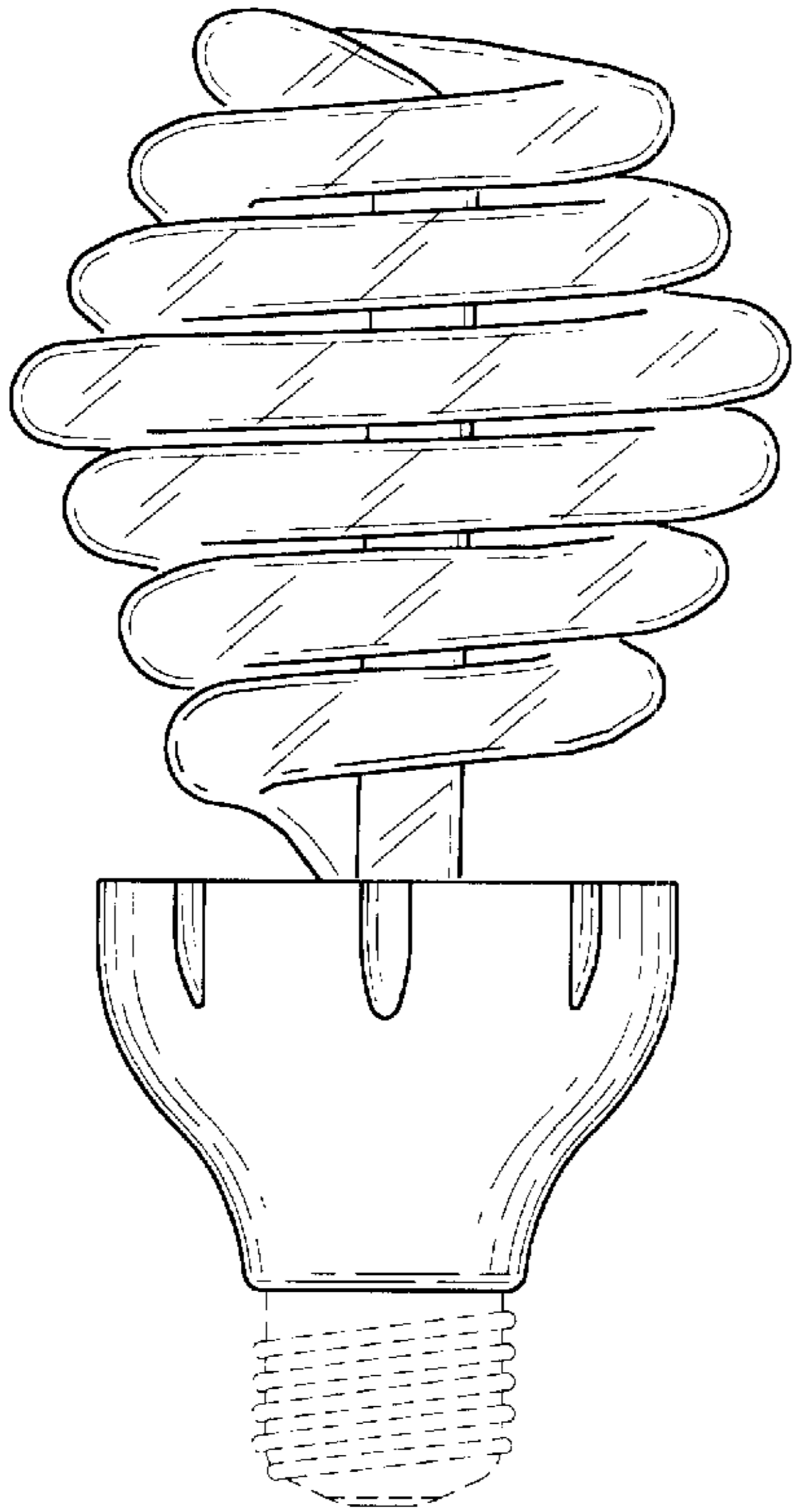

Fig. 6

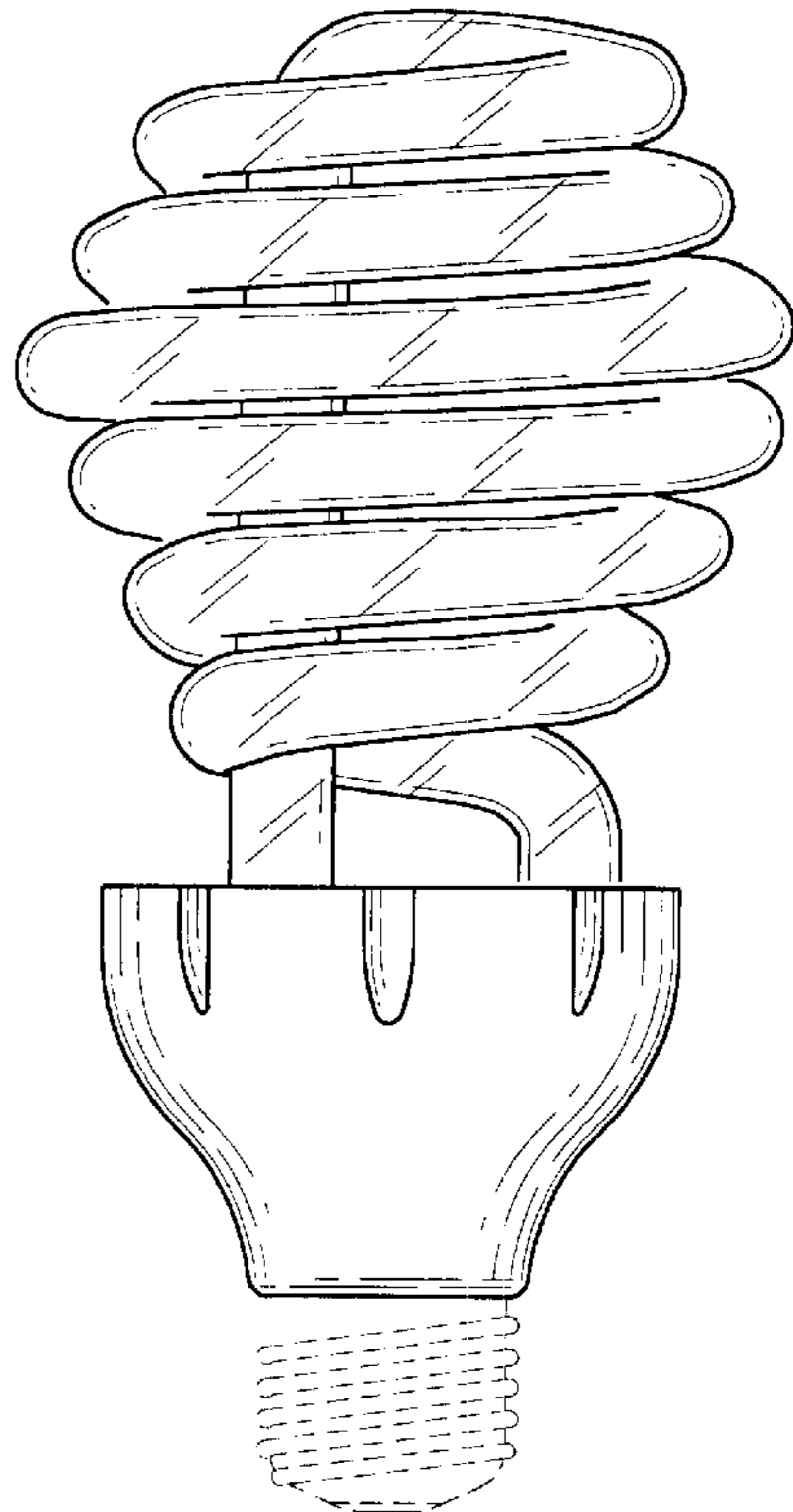

Fig. 7

