



US00D462357S

(12) **United States Design Patent**  
**Jenkins**

(10) **Patent No.:** **US D462,357 S**

(45) **Date of Patent:** **\*\* Sep. 3, 2002**

(54) **HAND HELD BAR CODE READER AND COMPUTER**

(75) **Inventor:** **Ian Jenkins**, Stony Brook, NY (US)

(73) **Assignee:** **Symbol Technologies, Inc.**, Holtsville, NY (US)

(\*\*) **Term:** **14 Years**

(21) **Appl. No.:** **29/157,310**

(22) **Filed:** **Mar. 15, 2002**

(51) **LOC (7) Cl.** ..... **14-02**

(52) **U.S. Cl.** ..... **D14/426; D14/347**

(58) **Field of Search** ..... D14/402-410,  
D14/399, 426-431, 420, 347; 235/145 A,  
145 R, 156, 168, 169, 172, 462.2; 341/22,  
23; 349/12

(56) **References Cited**

**U.S. PATENT DOCUMENTS**

D283,711 S	5/1986	Deura et al.	
D341,825 S	11/1993	Hamilon	
D363,470 S	* 10/1995	Yamamoto	..... D14/347
D367,648 S	3/1996	Smith et al.	
D414,760 S	10/1999	Herfield	
D417,445 S	* 12/1999	Chacon et al.	..... D14/426
D429,226 S	8/2000	Siddoway et al.	

D430,158 S	8/2000	Bhatia	
D430,159 S	8/2000	Bhatia	
6,097,606 A	* 8/2000	Groves et al.	..... 361/747
D431,562 S	10/2000	Bhatia	
D436,104 S	1/2001	Bhatia	
D447,141 S	* 8/2001	Itoh et al.	..... D14/385

\* cited by examiner

*Primary Examiner*—Kay H. Chin

(57) **CLAIM**

The ornamental design for a hand held bar code reader and computer, as shown and described.

**DESCRIPTION**

This application is related to U.S. patent application Ser. No. 29/144,589, filed Jul. 6, 2001, of the assignee.

FIG. 1 is a front perspective view of a hand held barcode reader and computer;

FIG. 2 is a front view thereof;

FIG. 3 is a right-side elevation view thereof;

FIG. 4 is a left-side elevation view thereof.

FIG. 5 is a back view thereof;

FIG. 6 is a top view thereof; and,

FIG. 7 is a bottom view thereof.

The keys are shown in broken lines in FIGS. 1 and 2 for illustrative purposes only and form no part of the claimed invention.

**1 Claim, 6 Drawing Sheets**

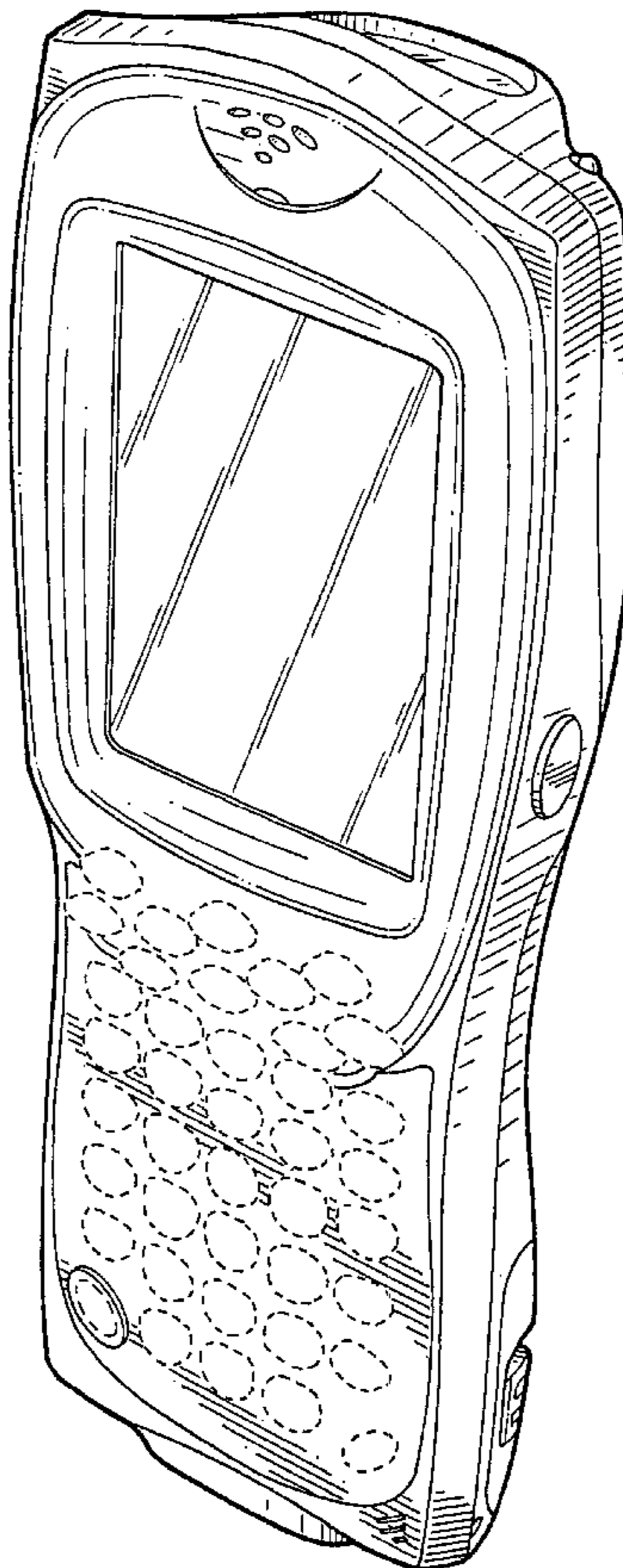

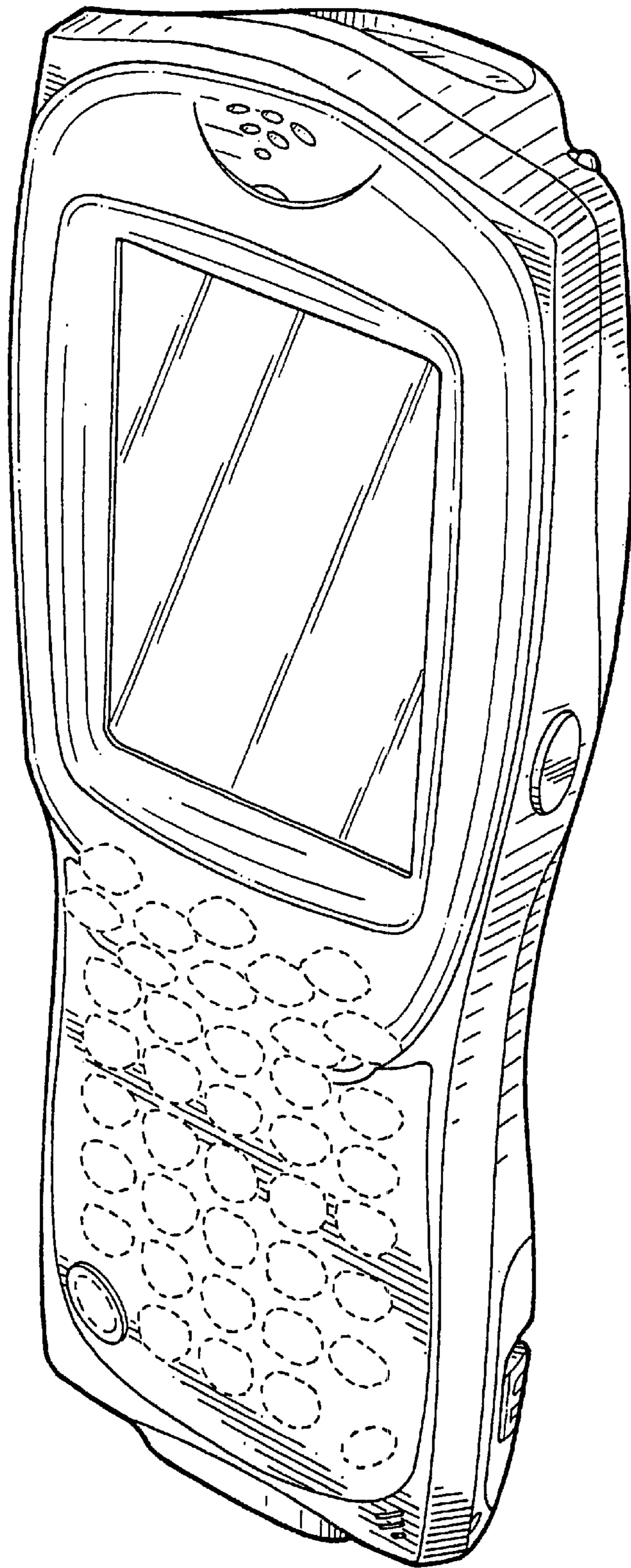

FIG. 1

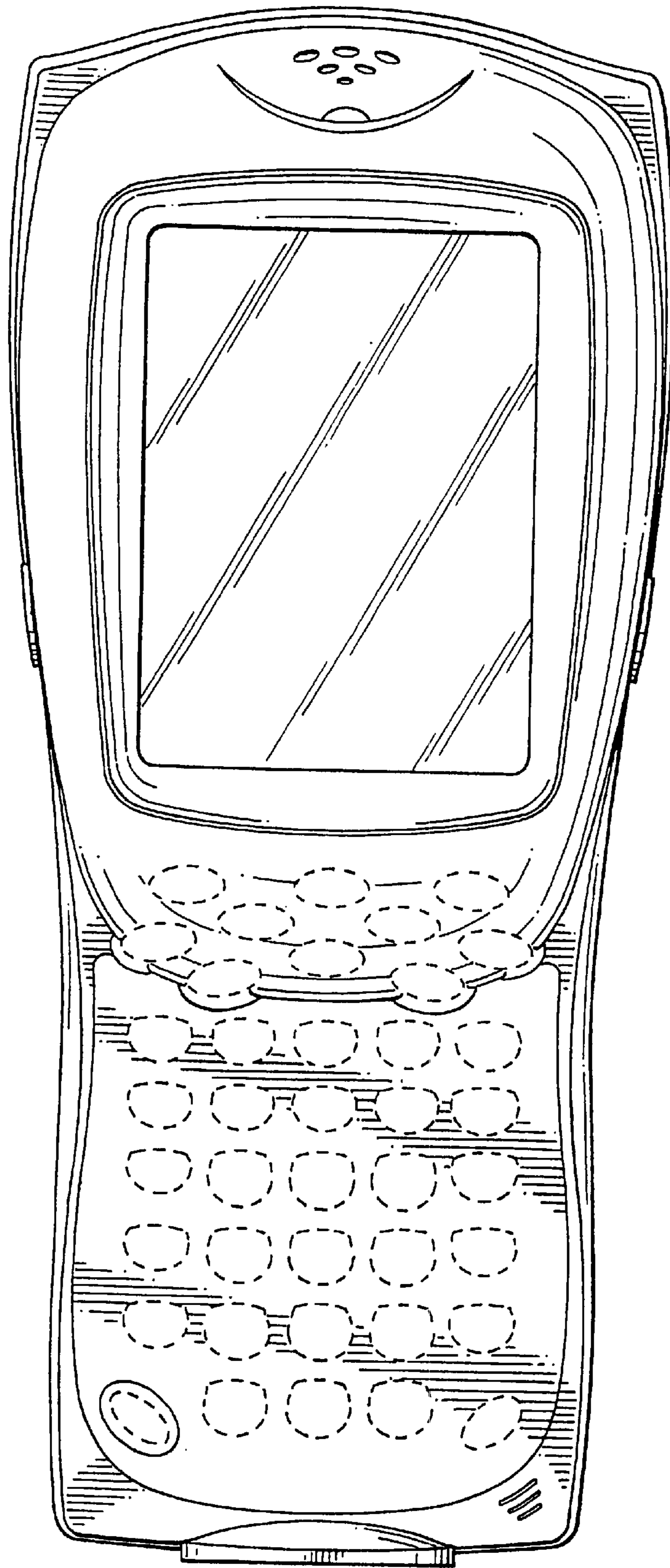

FIG. 2

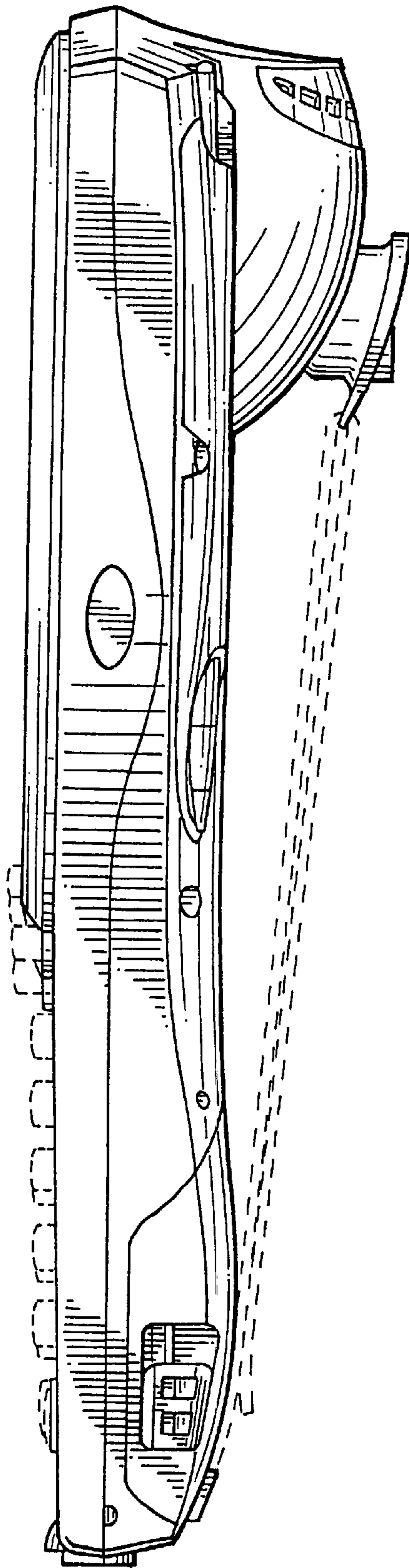

FIG. 3

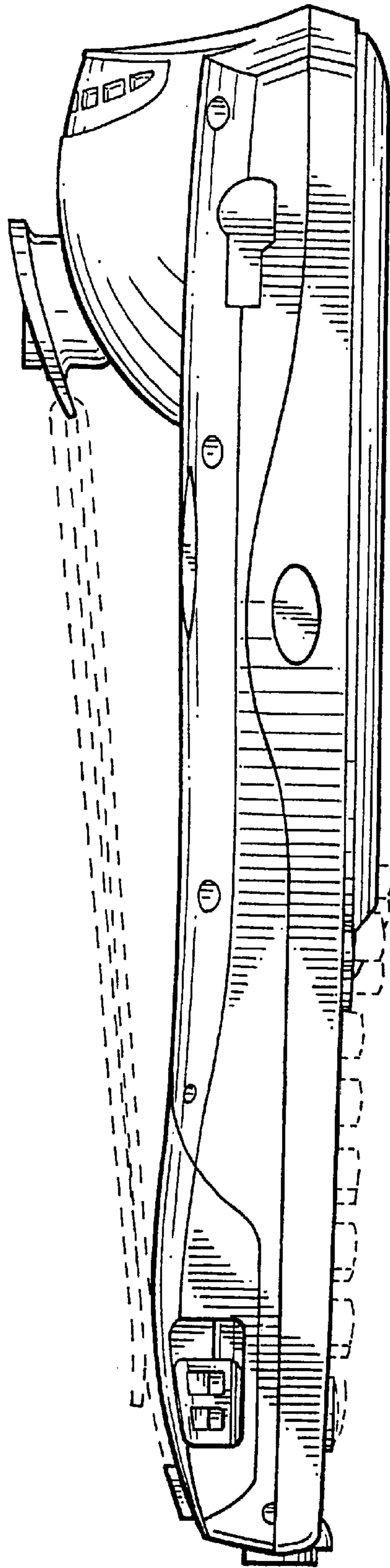

FIG. 4

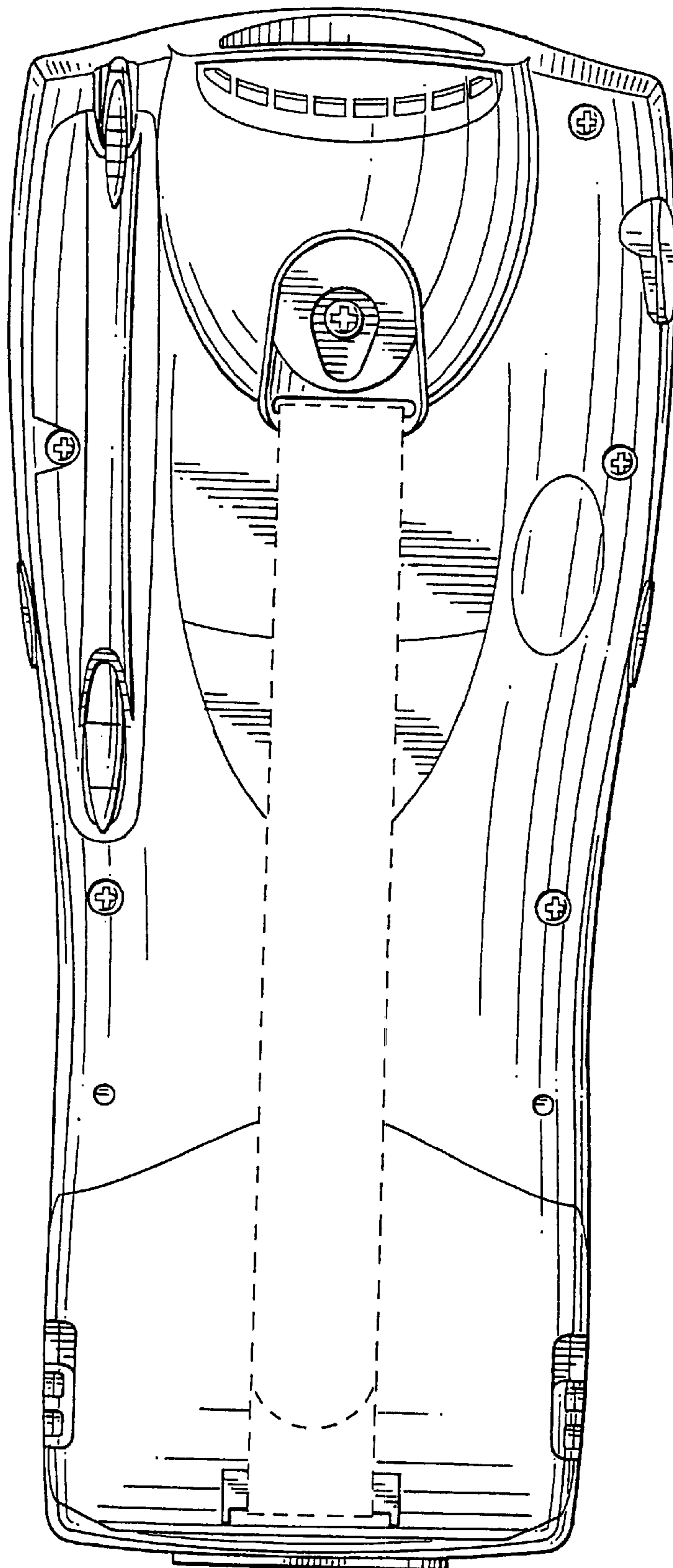

FIG. 5

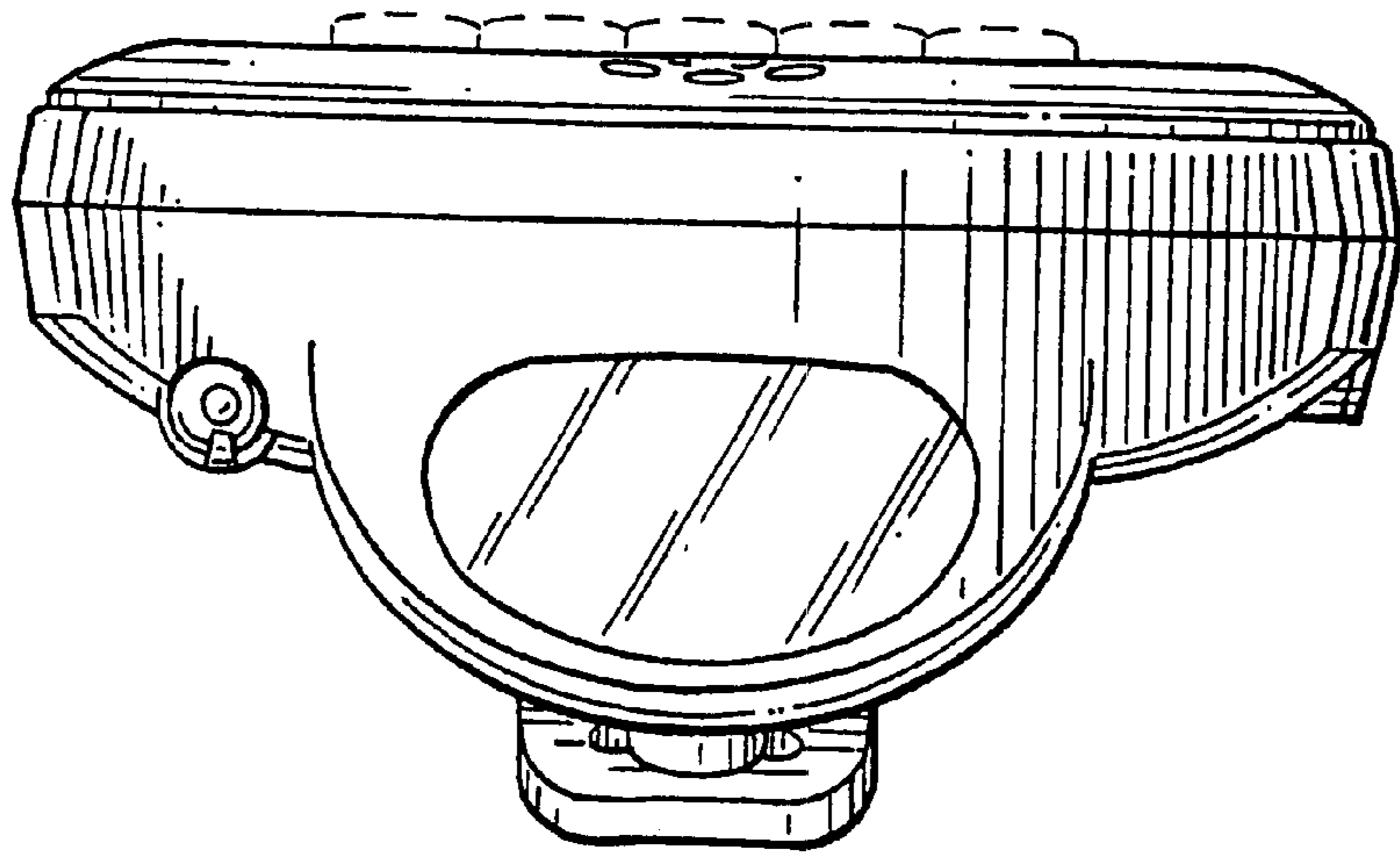

FIG. 6

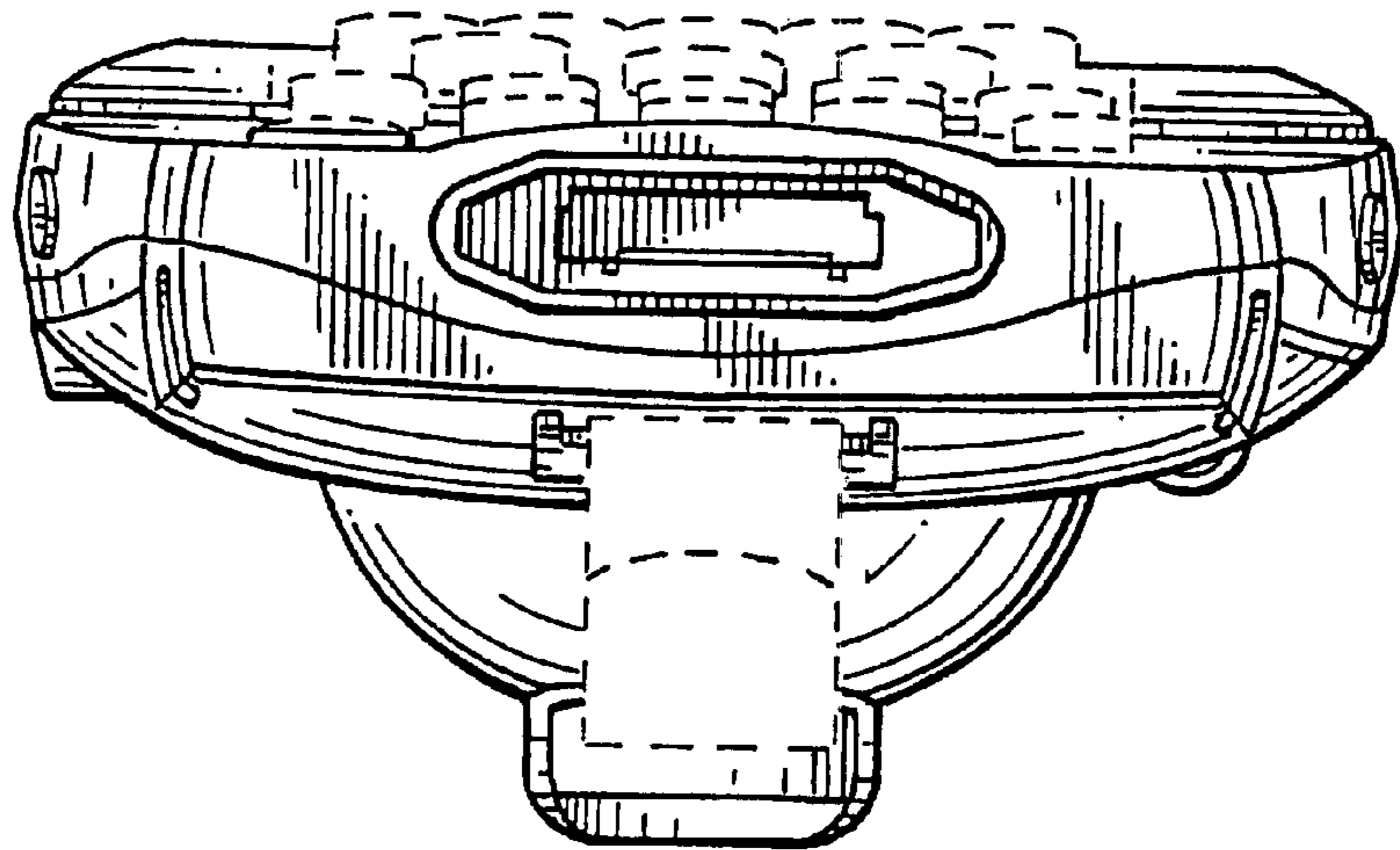

FIG. 7