



US00D462294S

(12) **United States Design Patent**  
**Walsh**

(10) **Patent No.:** **US D462,294 S**

(45) **Date of Patent:** **\*\* Sep. 3, 2002**

(54) **VASE**

(75) **Inventor:** **Claire Walsh, Dungarvan (IE)**

(73) **Assignee:** **Waterford Wedgwood PLC, Waterford (IE)**

(\*\*) **Term:** **14 Years**

(21) **Appl. No.:** **29/150,712**

(22) **Filed:** **Nov. 29, 2001**

(30) **Foreign Application Priority Data**

Jun. 1, 2001 (IE) ..... 191/01  
Jun. 1, 2001 (IE) ..... 196/01

(51) **LOC (7) Cl.** ..... **11-02**

(52) **U.S. Cl.** ..... **D11/146; D11/143**

(58) **Field of Search** ..... **D11/143, 144, D11/146, 147, 149, 152, 153, 154, 155; 47/41.01, 41.12, 41.13, 65.5, 66.6, 41.15; 206/423; 248/27.8; D7/509, 523**

(56) **References Cited**

**U.S. PATENT DOCUMENTS**

D40,562 S	*	3/1910	Dawley	.....	D11/143
D77,556 S	*	1/1929	Kopp	.....	D11/143
D119,618 S	*	3/1940	Fuerst	.....	D11/143
2,996,208 A	*	8/1961	Schroeder	.....	D7/523
D260,088 S	*	8/1981	Murphy	.....	D11/146
D287,204 S	*	12/1986	Bierlein et al.	.....	D7/523
D320,493 S	*	10/1991	Fewell	.....	D11/155
D331,173 S	*	11/1992	Durand	.....	D7/523
D365,041 S	*	12/1995	Dollinger	.....	D11/146
D446,748 S	*	8/2001	Hutton	.....	D11/146

\* cited by examiner

*Primary Examiner*—Doris V. Coles

*Assistant Examiner*—Mimosa De

(74) *Attorney, Agent, or Firm*—Burns, Doane, Swecker & Mathis, L.L.P.

(57) **CLAIM**

The ornamental design for a vase, as shown and described.

**DESCRIPTION**

FIG. 1 is a perspective view of a vase showing a first embodiment of my new design;  
 FIG. 2 is a top plan view thereof;  
 FIG. 3 is a left side elevation view thereof, the right side view being a mirror image thereof;  
 FIG. 4 is front elevational view thereof, the rear view being a mirror image view thereof;  
 FIG. 5 is a bottom view thereof;  
 FIG. 6 is a perspective view of a vase showing a second embodiment of my new design;  
 FIG. 7 is a top plan view thereof;  
 FIG. 8 is a left side elevational view thereof, the right side view being a mirror image thereof;  
 FIG. 9 is front elevational view thereof, the rear view being a mirror image view thereof;  
 FIG. 10 is a bottom plan view thereof;  
 FIG. 11 is a perspective view of a vase showing a third embodiment of my new design;  
 FIG. 12 is a top plan view thereof;  
 FIG. 13 is a left side elevational view thereof, the right side view being a mirror image thereof;  
 FIG. 14 is front elevational view thereof, the rear view being a mirror image view thereof;  
 FIG. 15 is a bottom plan view thereof;  
 FIG. 16 is a perspective view of a vase showing a fourth embodiment of my new design;  
 FIG. 17 is a top plan view thereof;  
 FIG. 18 is a left side elevational view thereof, the right side view being a mirror image thereof;  
 FIG. 19 is front elevational view thereof; the rear view being a mirror image view thereof; and,  
 FIG. 20 is a bottom plan view thereof.

**1 Claim, 12 Drawing Sheets**

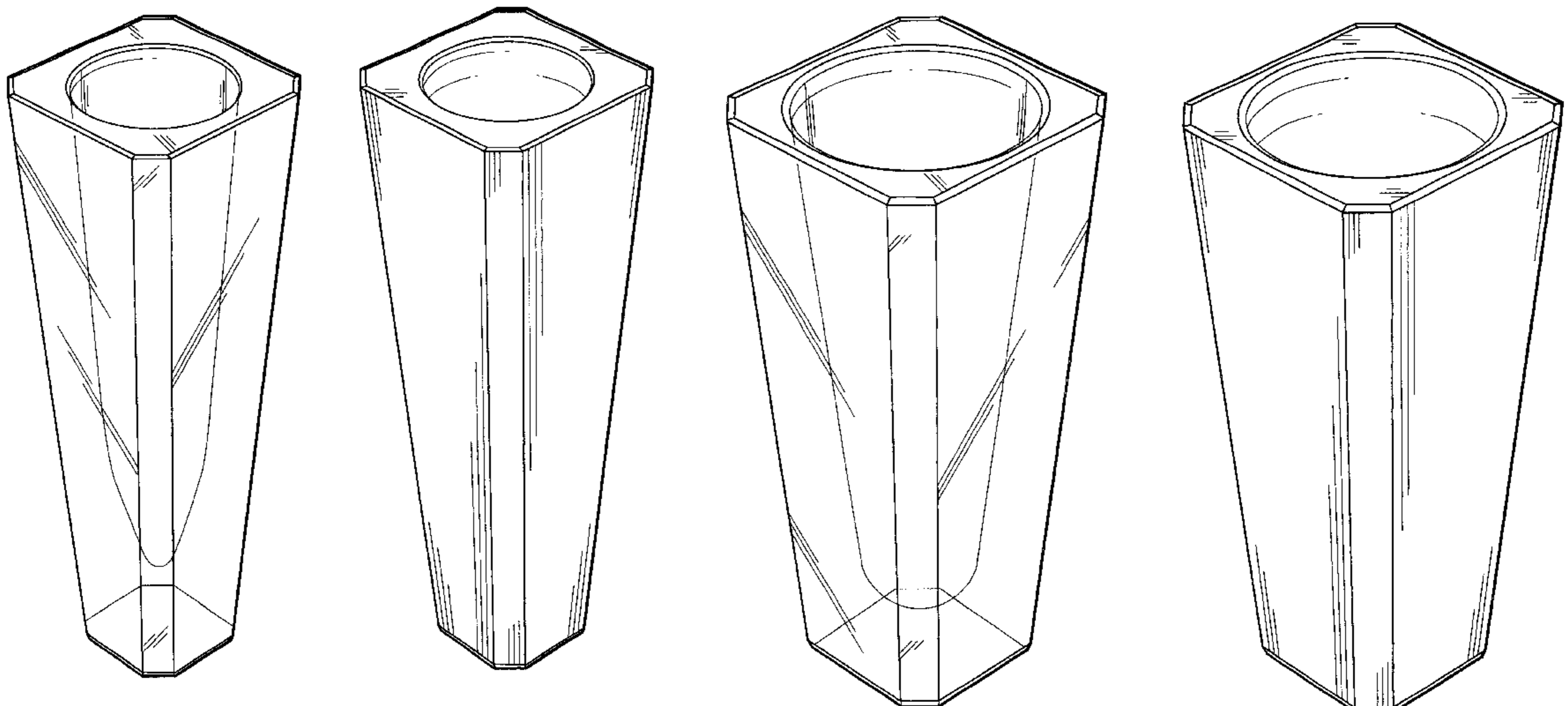

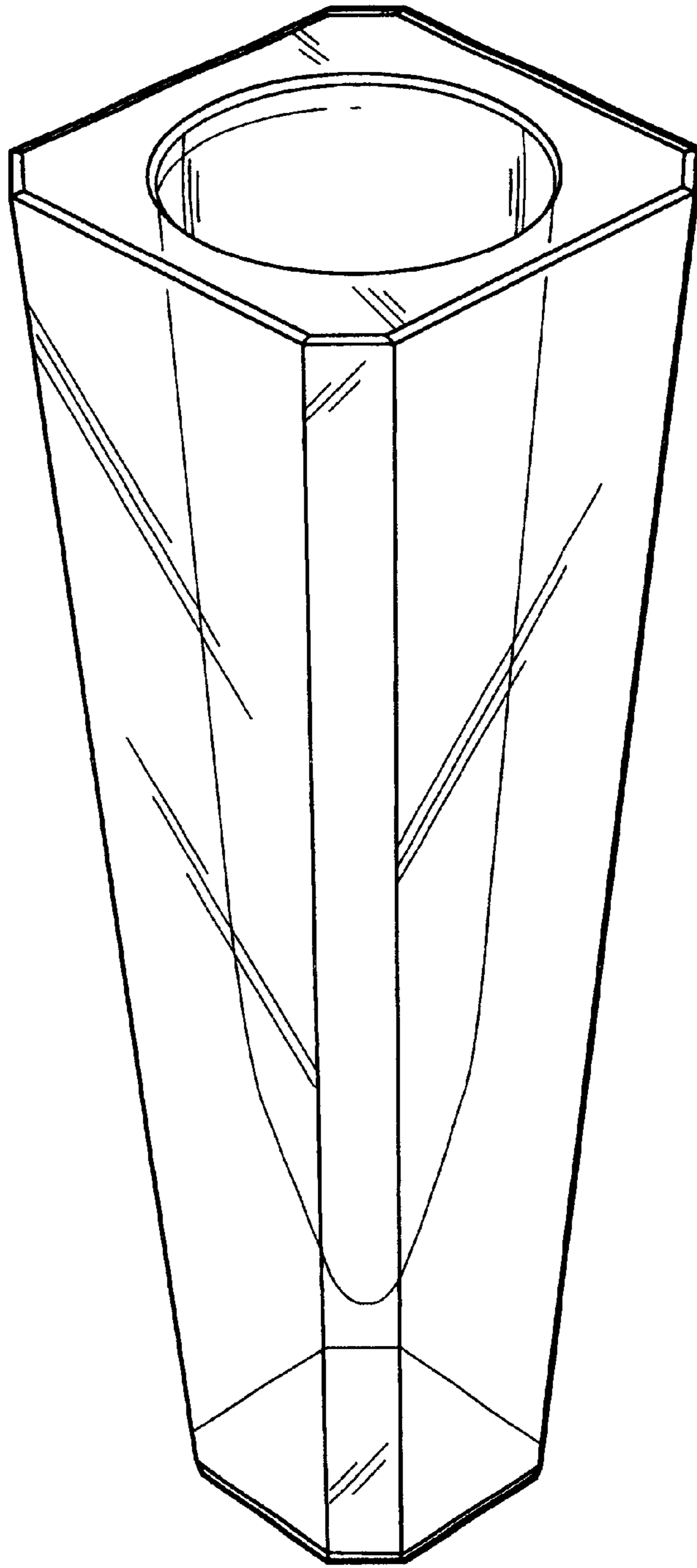

FIG. 1

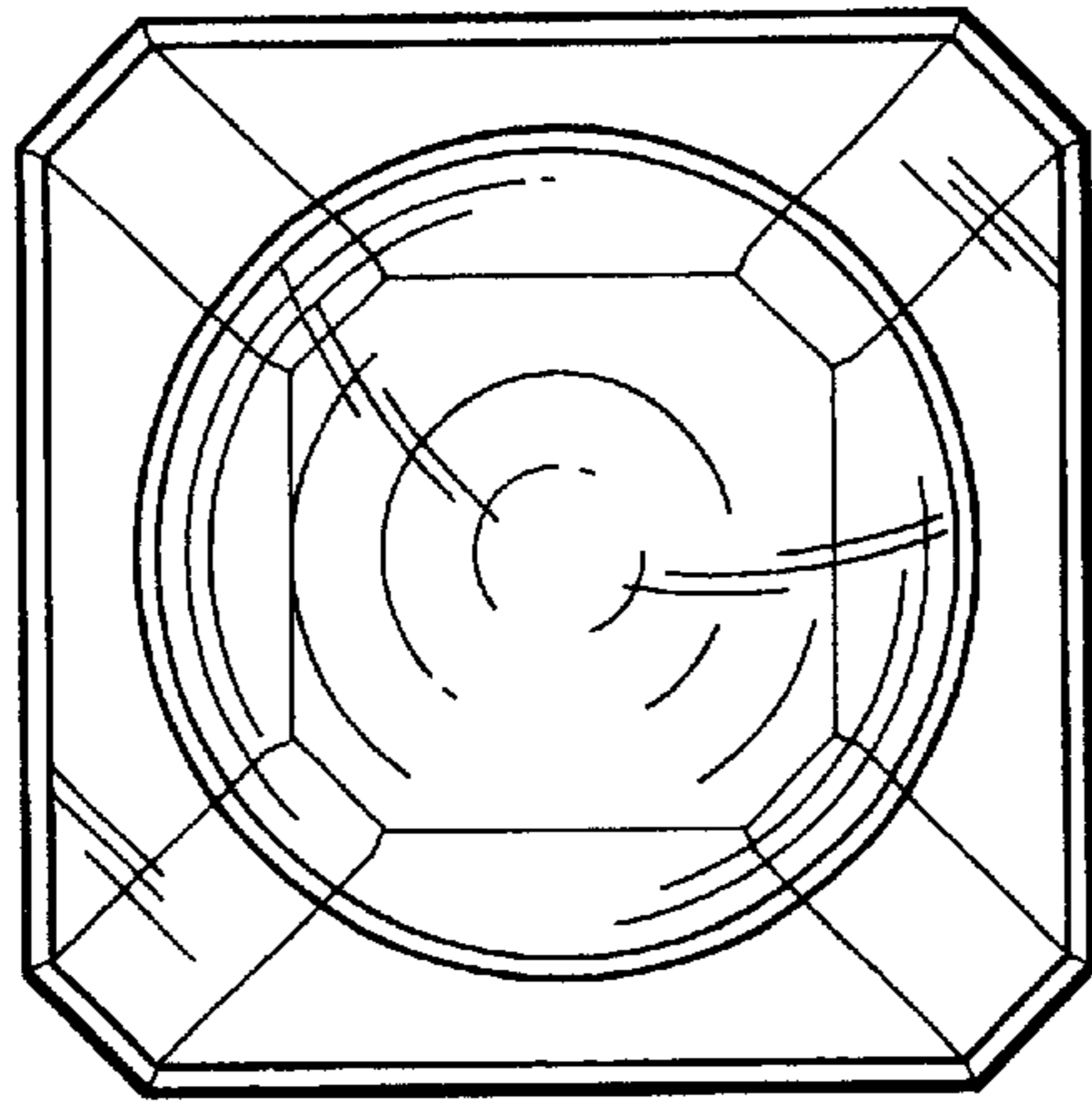

FIG. 2

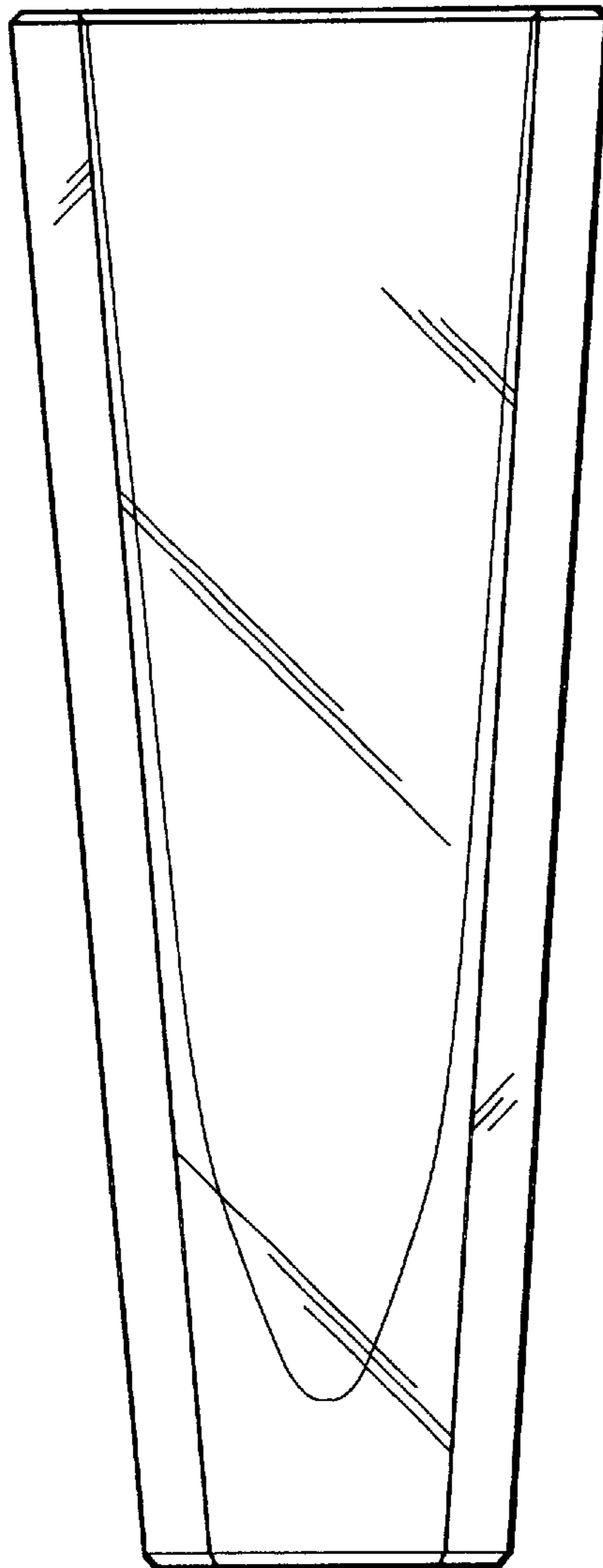

FIG. 3

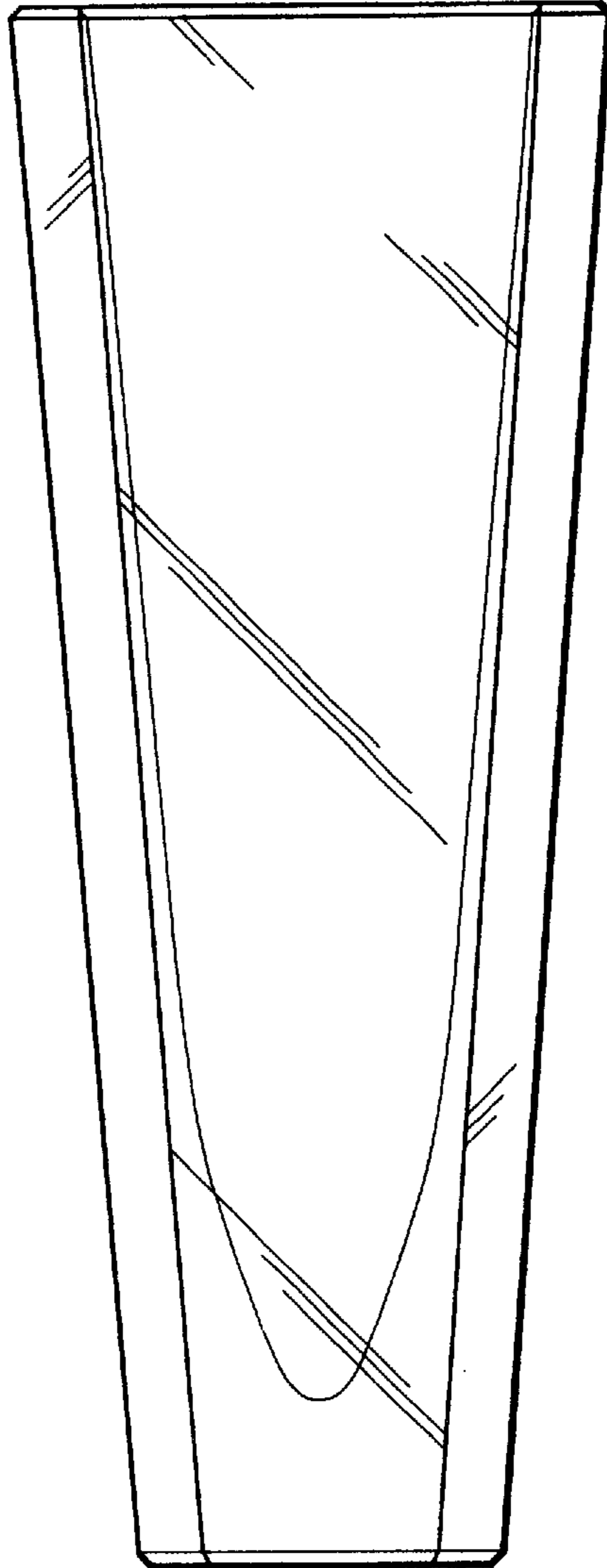

FIG. 4

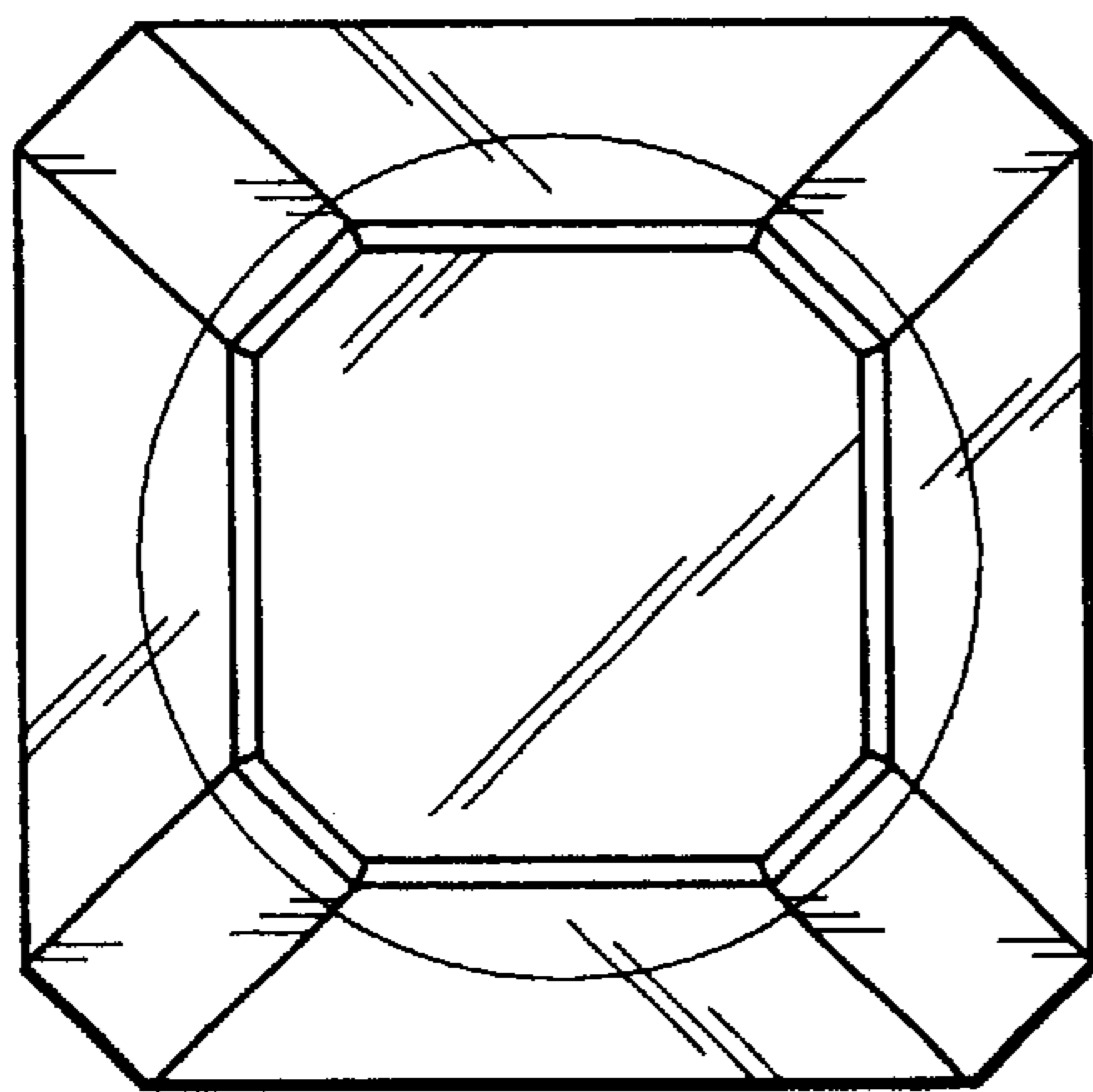

FIG. 5

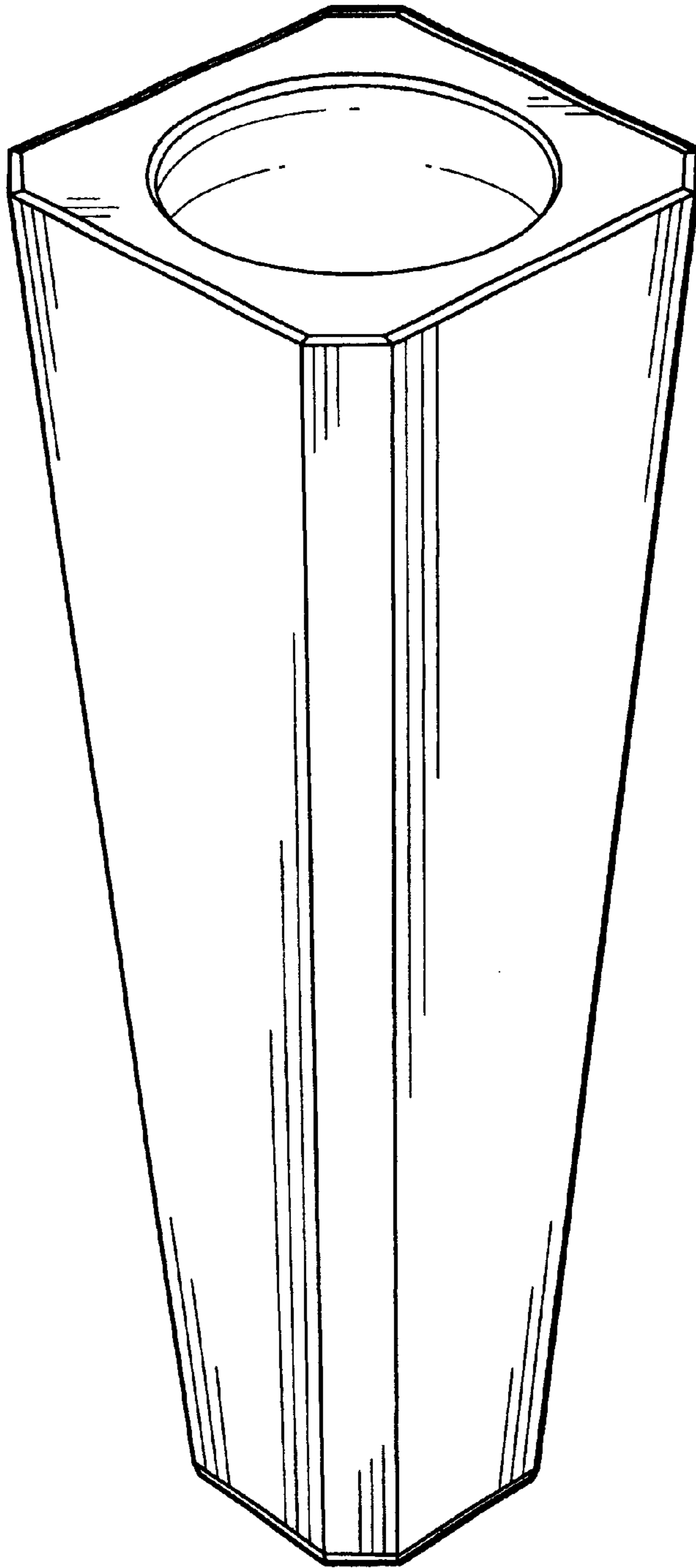

FIG. 6

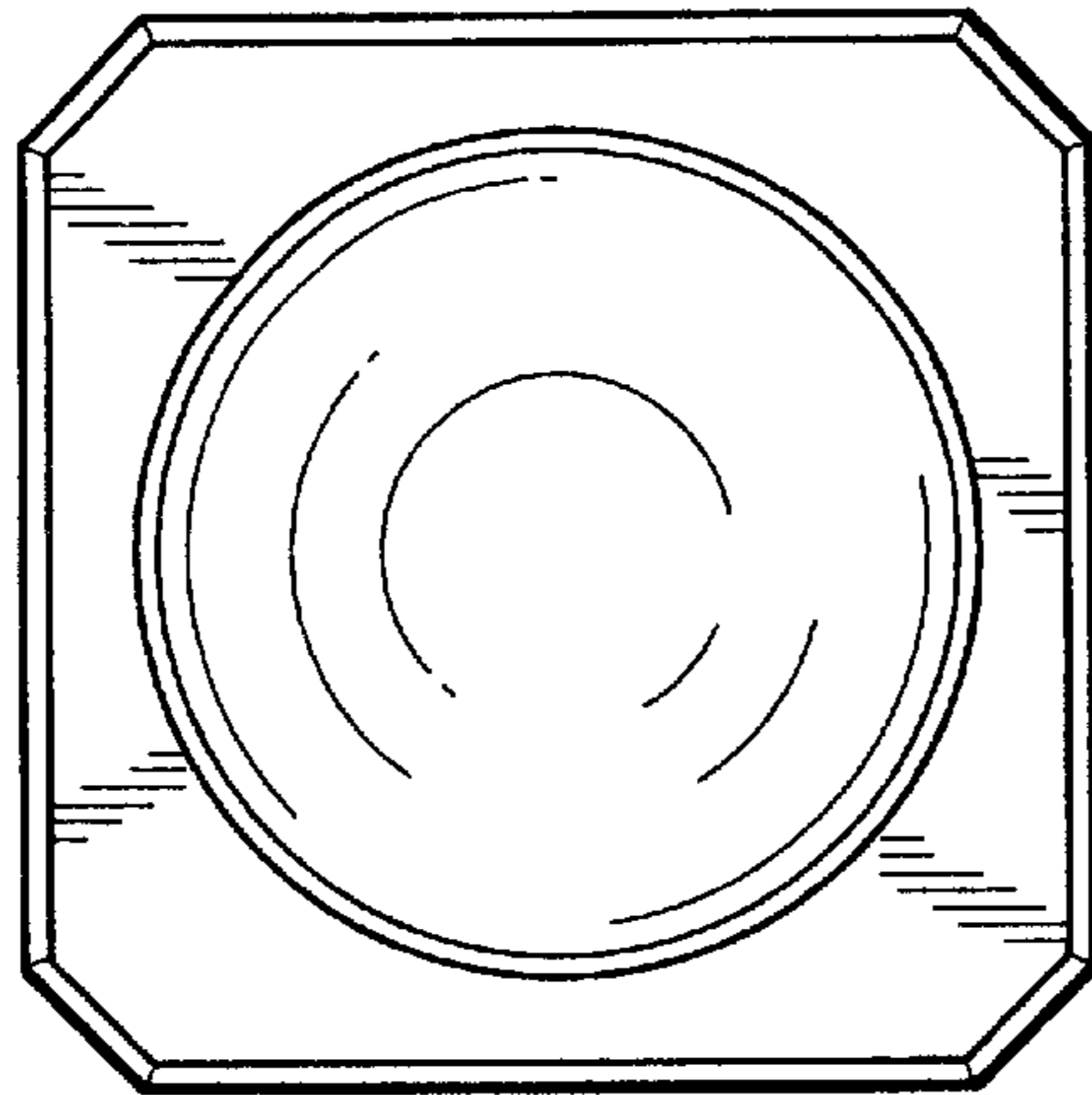

FIG. 7

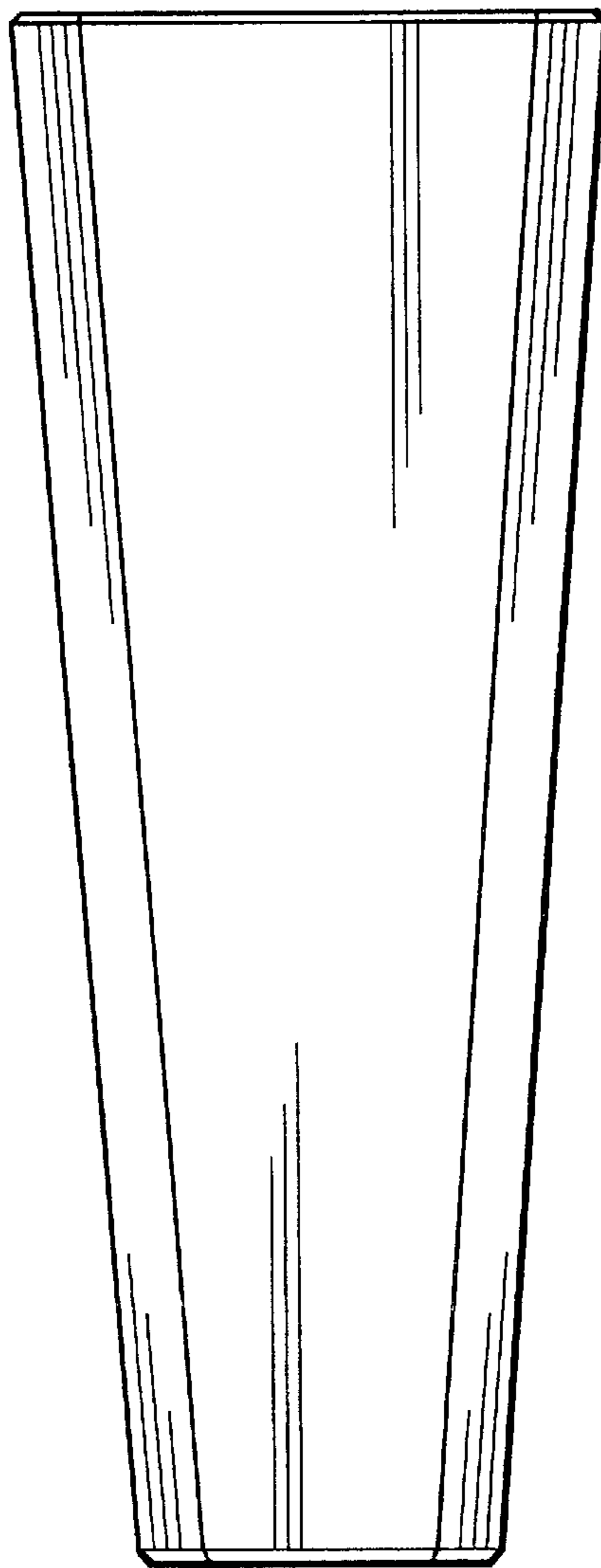

FIG. 8

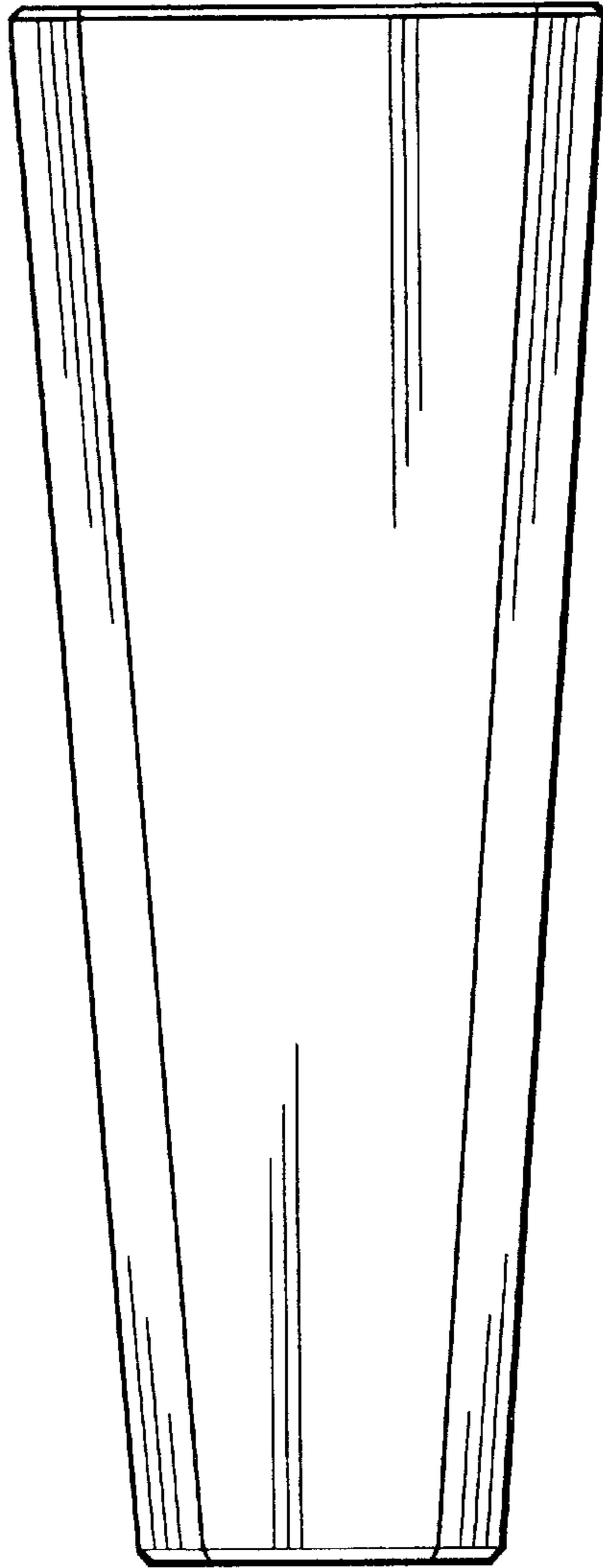

FIG. 9

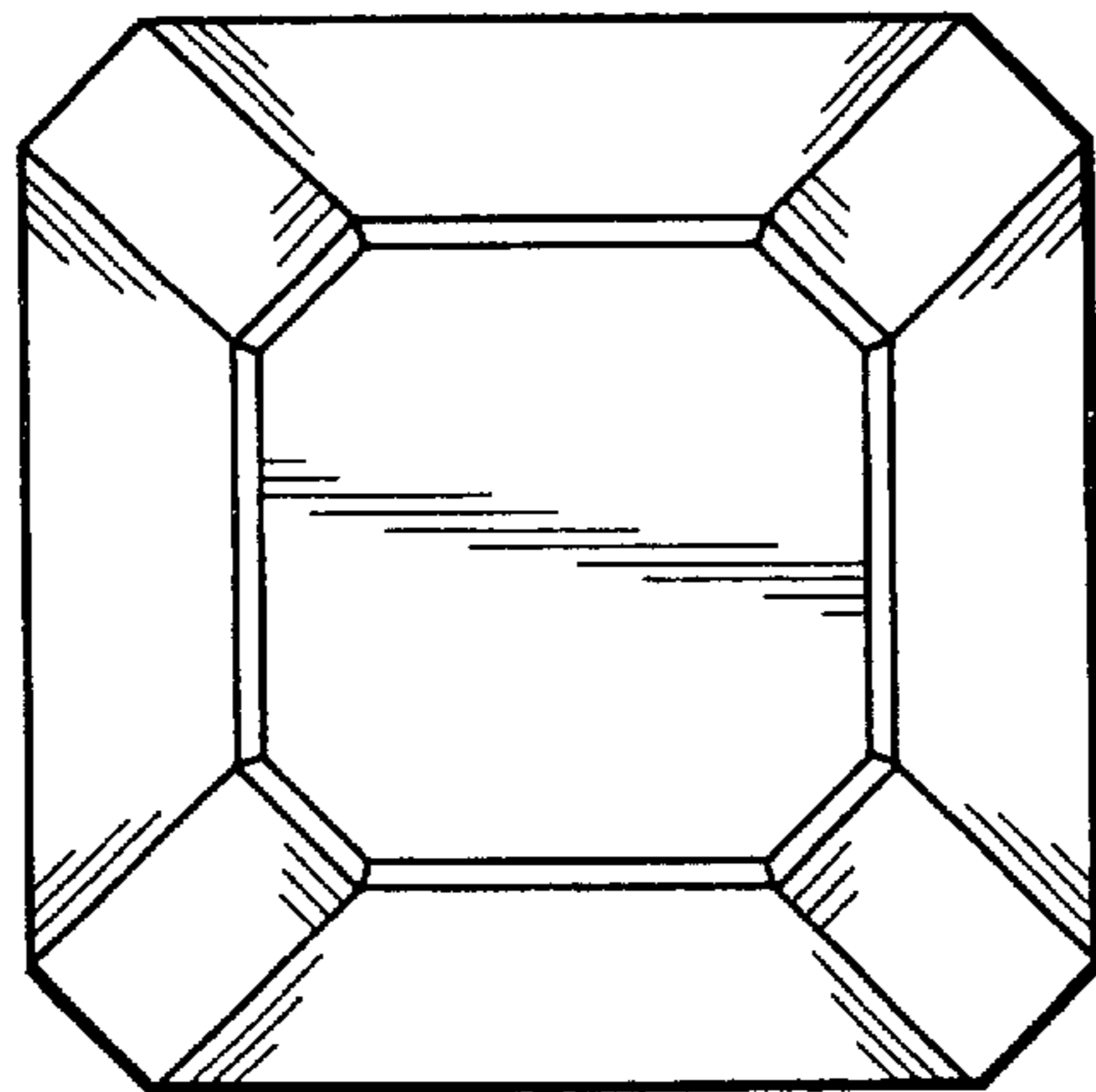

FIG. 10

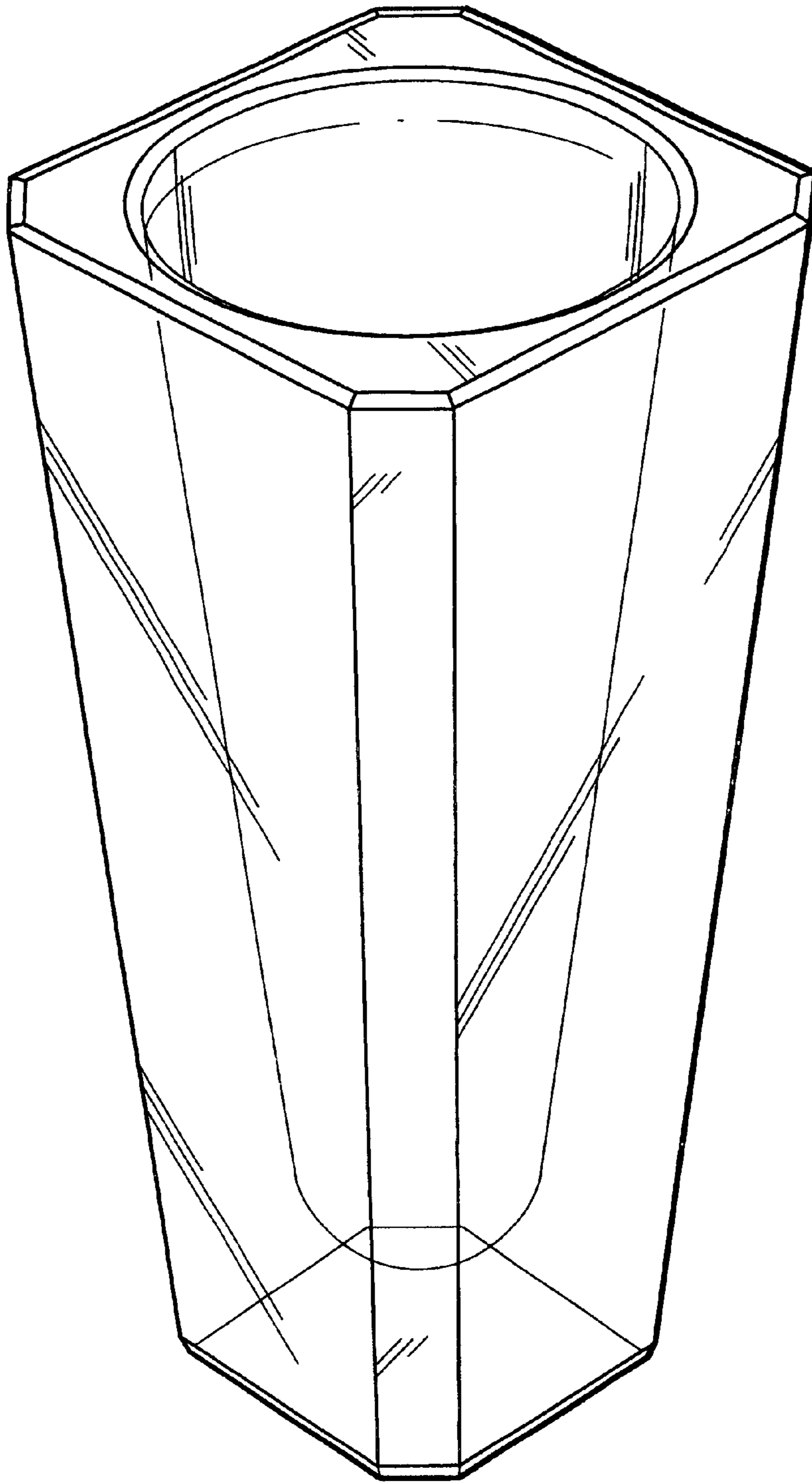

FIG. 11



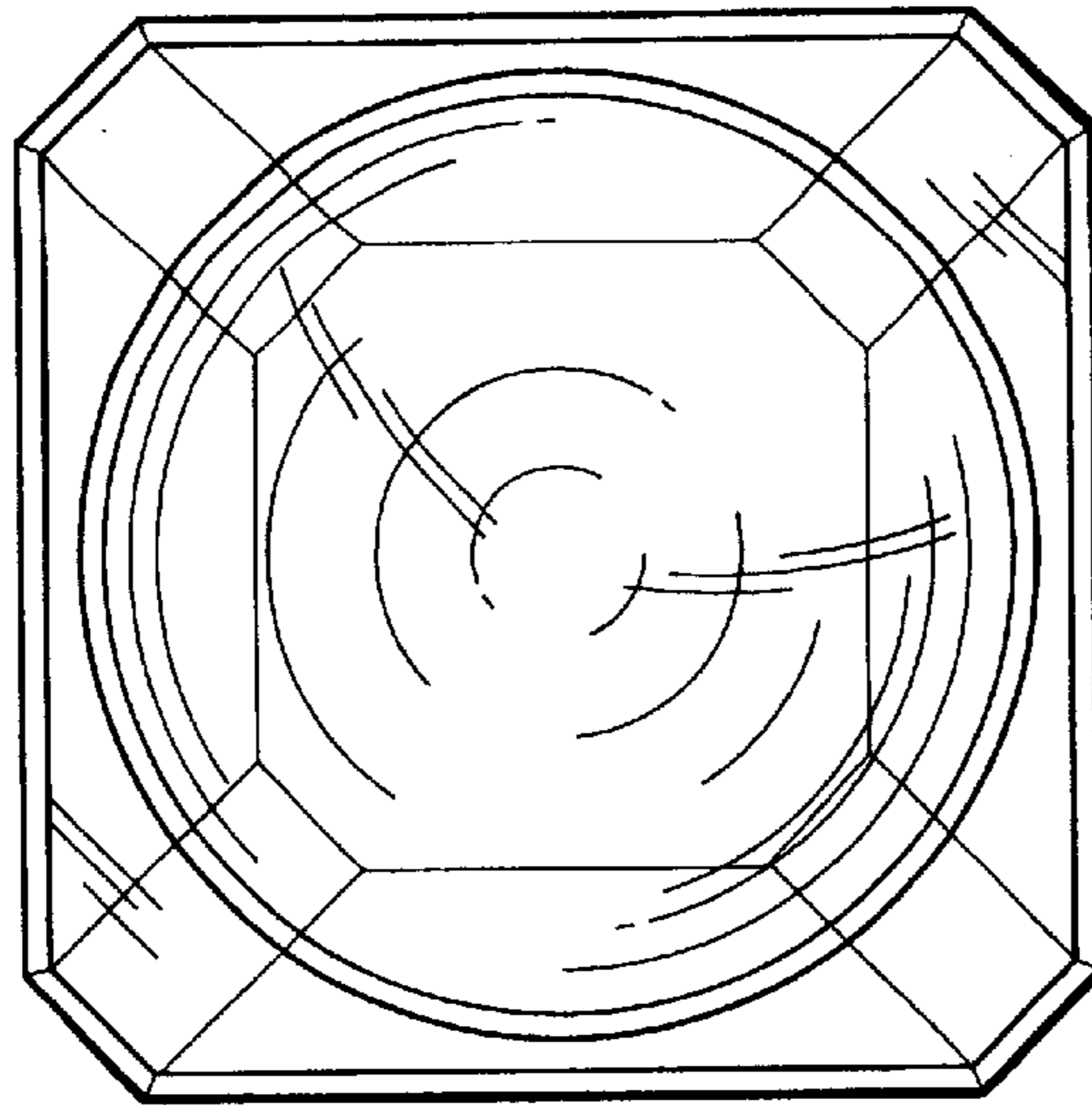

FIG. 12

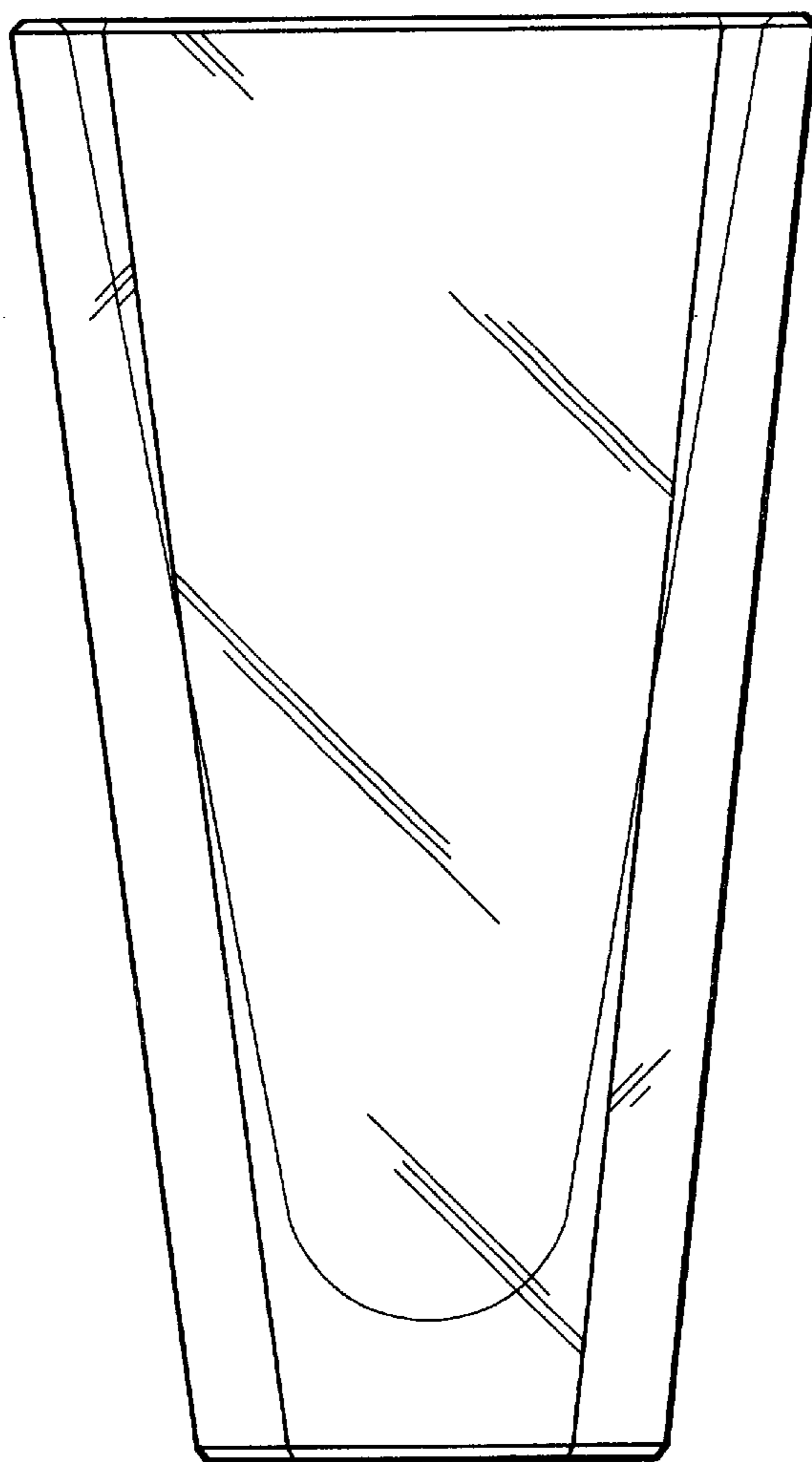

FIG. 13

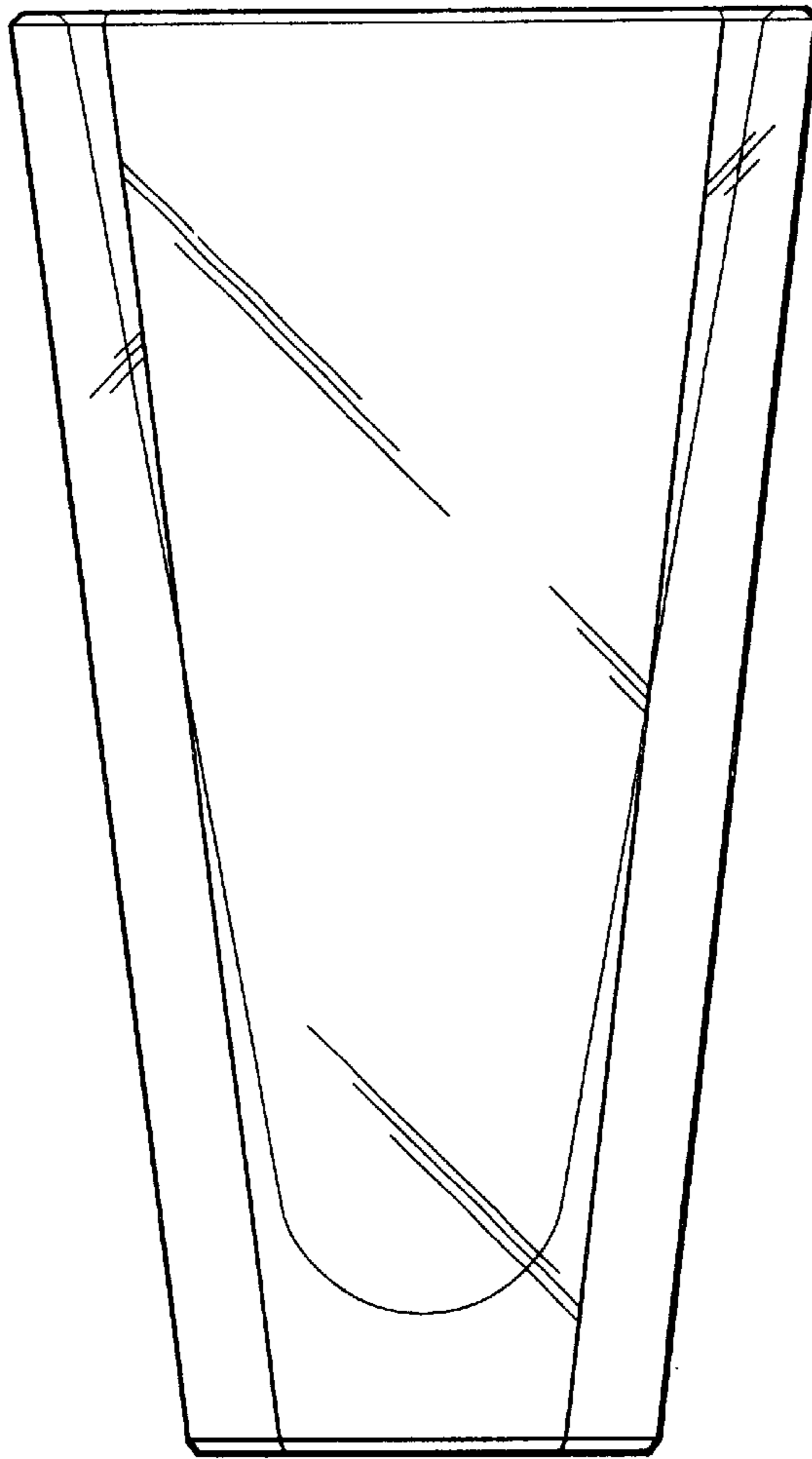

FIG. 14

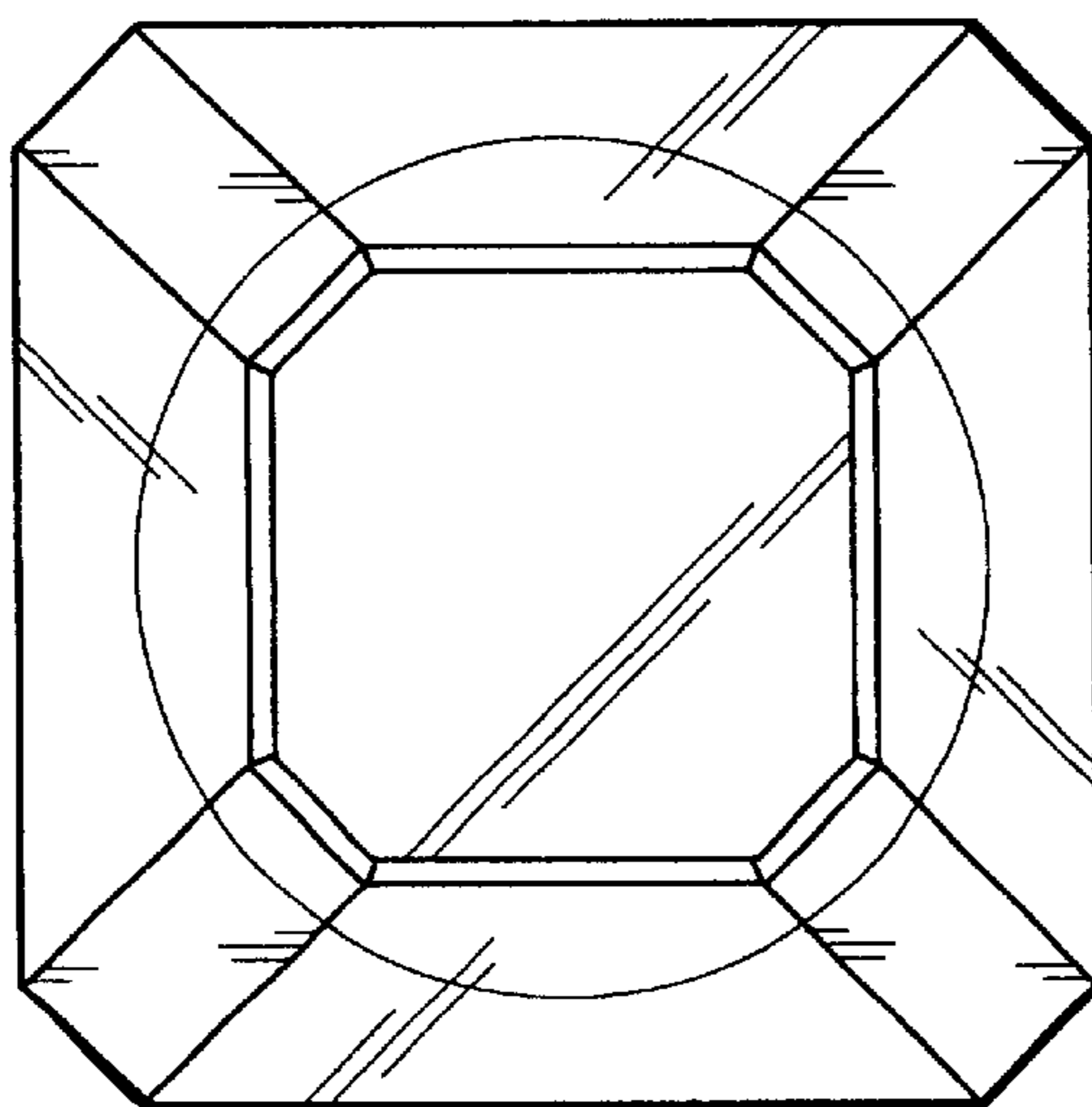

FIG. 15

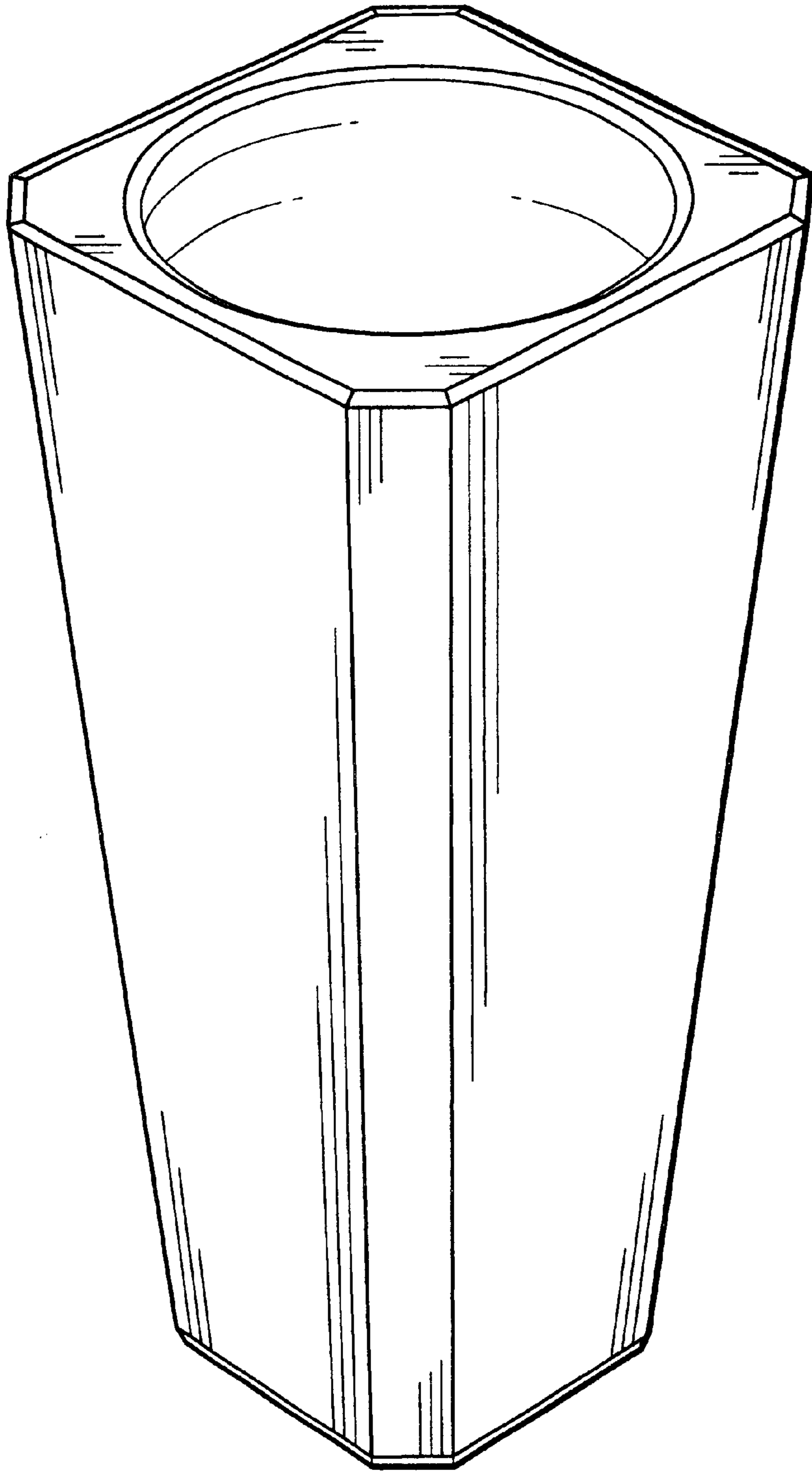

FIG. 16

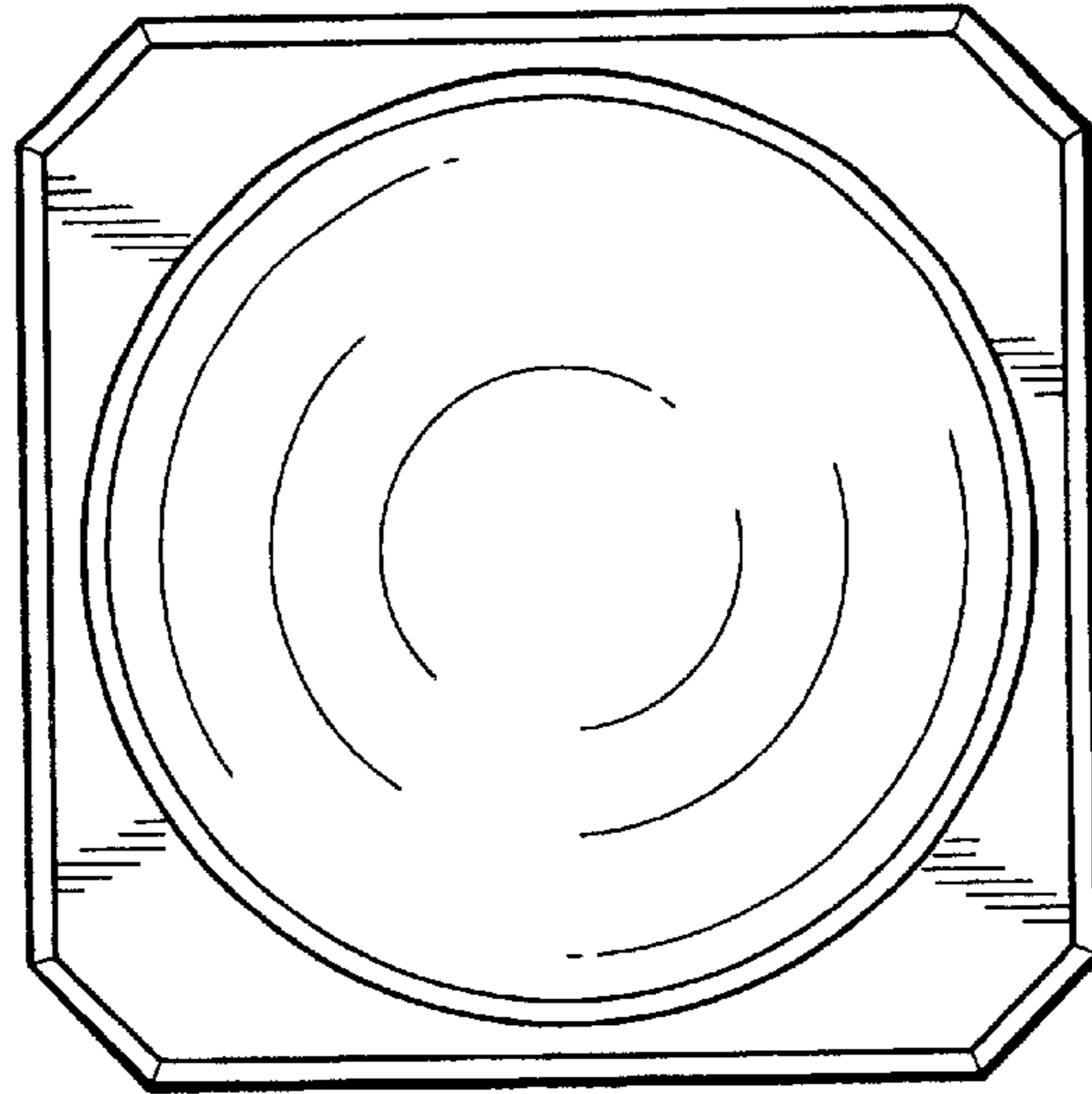

FIG. 17

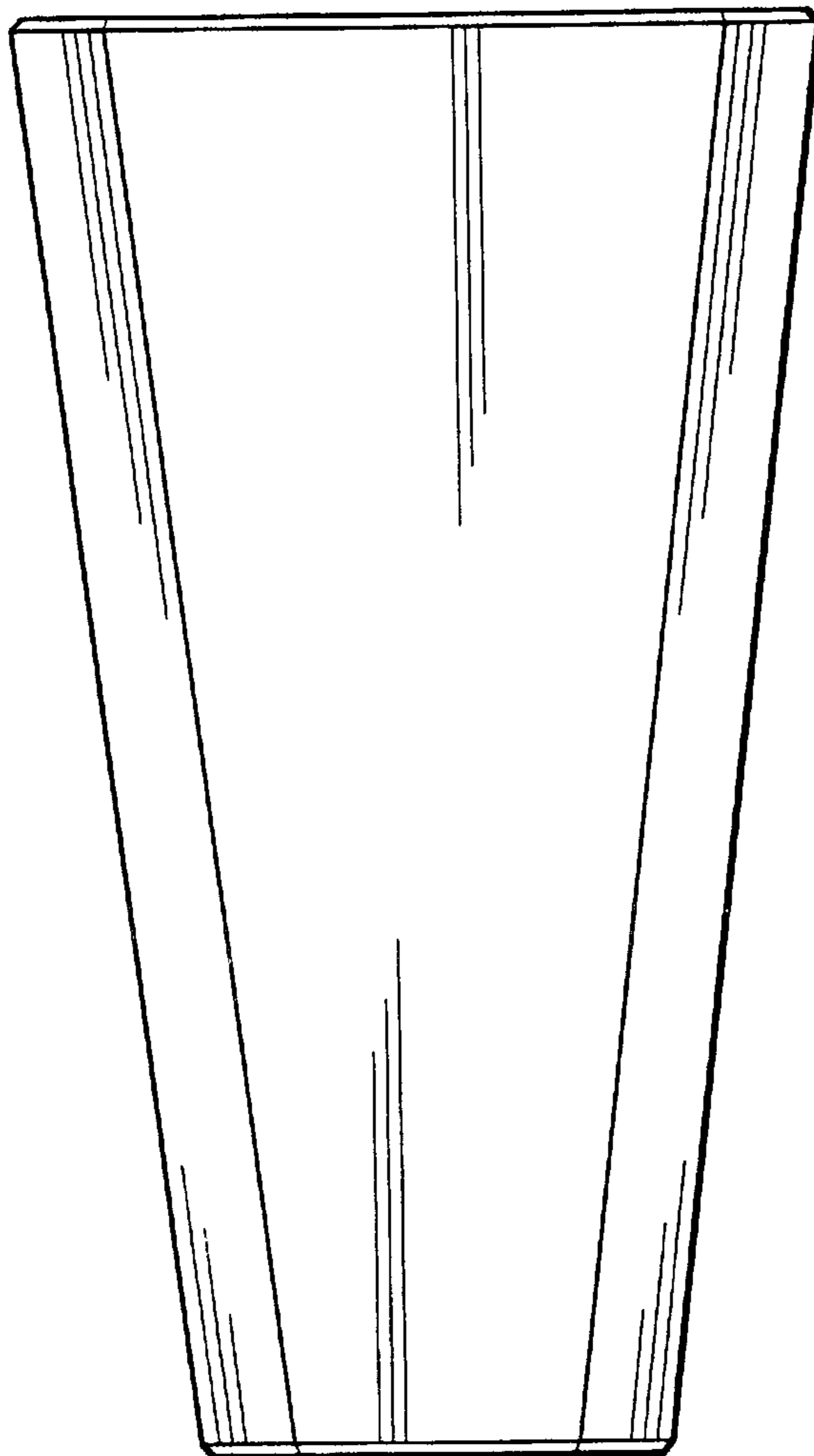

FIG. 18

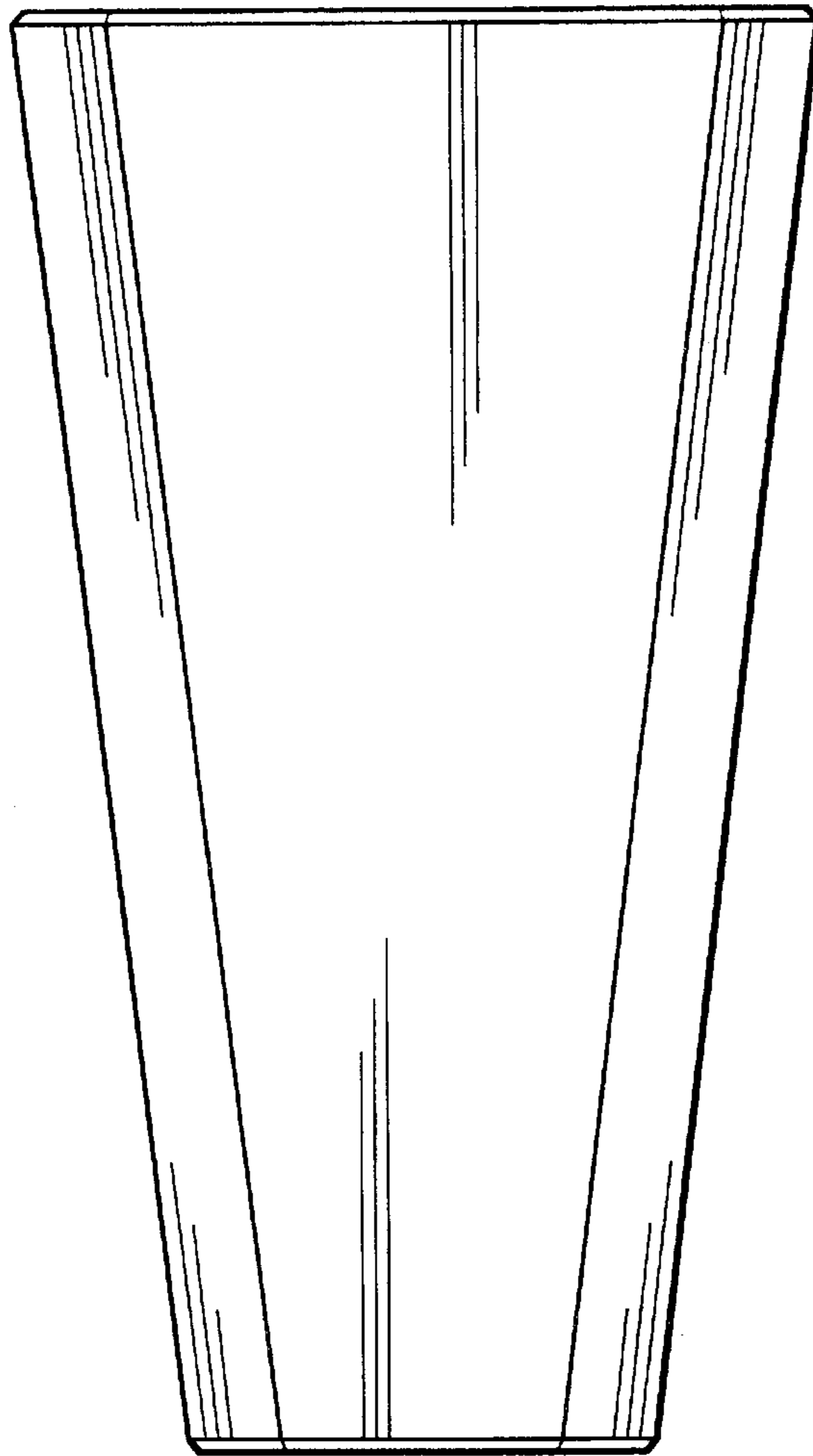

FIG. 19

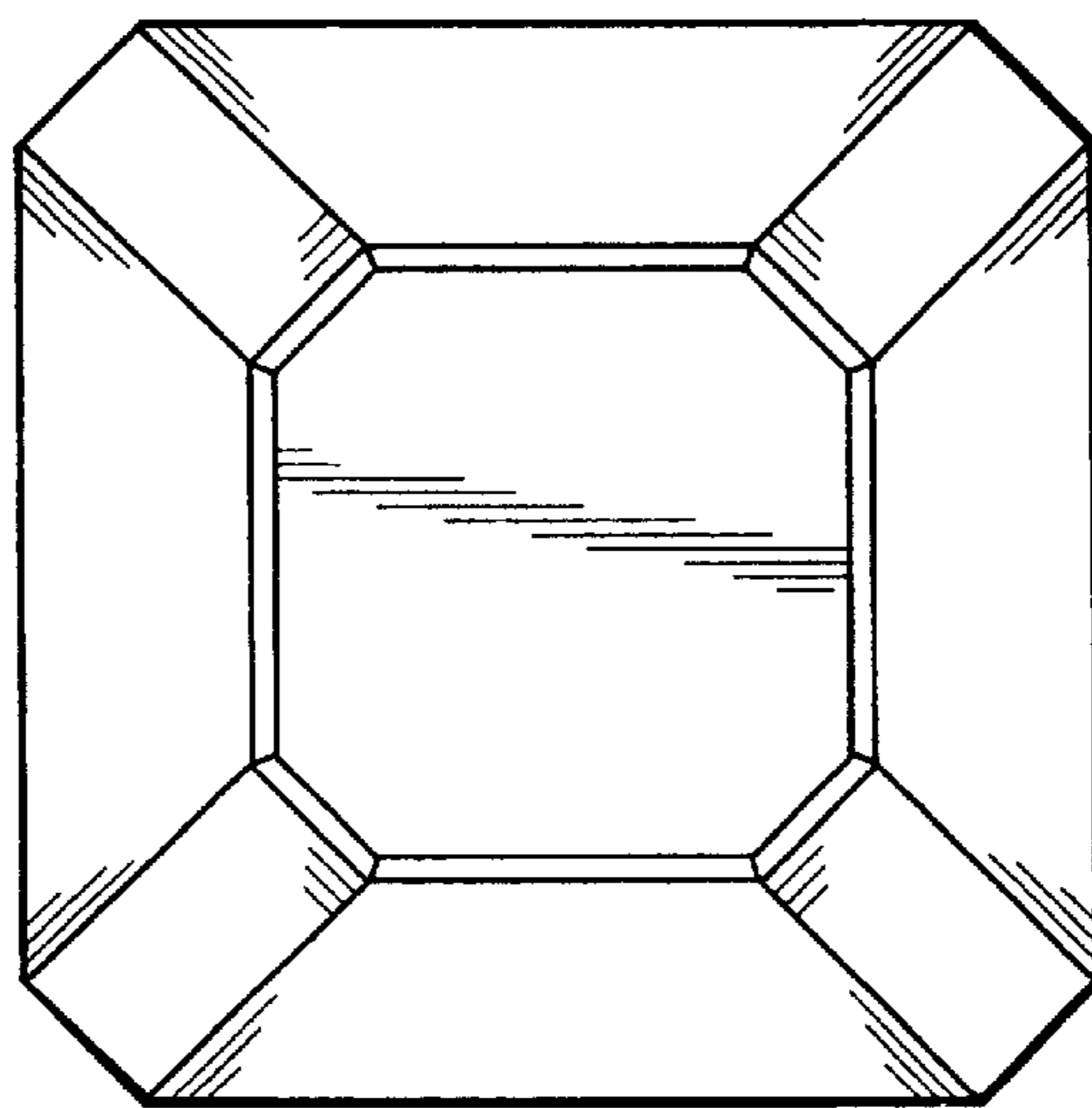

FIG. 20