



US00D462268S

(12) **United States Design Patent**
Schroeder et al.

(10) **Patent No.: US D462,268 S**

(45) **Date of Patent: ** Sep. 3, 2002**

(54) **SPRAY NOZZLE**

(75) Inventors: **Joseph G. Schroeder**, North Royalton;
Daniel J. Thompson, Vermilion, both
of OH (US)

(73) Assignee: **Nordson Corporation**, Westlake, OH
(US)

(**) Term: **14 Years**

(21) Appl. No.: **29/148,881**

(22) Filed: **Sep. 28, 2001**

(51) **LOC (7) Cl.** **09-07**

(52) **U.S. Cl.** **D9/435; D9/447**

(58) **Field of Search** D9/435, 447-449;
222/402.23, 402.1, 402.21, 566, 567, 570,
571, 575

(56) **References Cited**

U.S. PATENT DOCUMENTS

D130,597 S	*	12/1941	Derham et al.	D9/449
2,954,903 A	*	10/1960	Collins	222/402.23
3,093,274 A	*	6/1963	Galbierz	222/566
D198,239 S	*	5/1964	Schultz	D9/448
3,459,344 A	*	8/1969	Mackey	222/567
3,920,165 A	*	11/1975	Schultz	22/402.23
3,954,208 A	*	5/1976	Brill	222/402.23
4,382,530 A	*	5/1983	Calisto	222/567
D277,827 S	*	3/1985	Olsson	D9/447
5,553,755 A	*	9/1996	Bonewald et al.	222/402.23

* cited by examiner

Primary Examiner—Dominic Simone

(74) *Attorney, Agent, or Firm*—Calfee, Halter & Griswold
LLP

(57) **CLAIM**

The ornamental design for a spray nozzle, as shown and described.

DESCRIPTION

FIG. 1 is a perspective view of a spray nozzle showing the new design;
 FIG. 2 is a side view of the spray nozzle of FIG. 1;
 FIG. 3 is another side view of the spray nozzle of FIG. 1, rotated 90 degrees from FIG. 2;
 FIG. 4 is a top view of the spray nozzle of FIG. 1;
 FIG. 5 is a bottom view of the spray nozzle of FIG. 1;
 FIG. 6 is a perspective view of a second embodiment showing a spray nozzle of the new design;
 FIG. 7 is a side view of the spray nozzle of FIG. 6;
 FIG. 8 is another side view of the spray nozzle of FIG. 6, rotated 90 degrees from FIG. 7;
 FIG. 9 is a top view of the spray nozzle of FIG. 6;
 FIG. 10 is a bottom view of the spray nozzle of FIG. 6;
 FIG. 11 is a perspective view of a third embodiment showing a spray nozzle of the new design;
 FIG. 12 is a side view of the spray nozzle of FIG. 11;
 FIG. 13 is another side view of the spray nozzle of FIG. 11, rotated 90 degrees from FIG. 12;
 FIG. 14 is a top view of the spray nozzle of FIG. 11;
 FIG. 15 is a bottom view of the spray nozzle of FIG. 11;
 FIG. 16 is a perspective view of a fourth embodiment showing a spray nozzle of the new design;
 FIG. 17 is a side view of the spray nozzle of FIG. 16;
 FIG. 18 is another side view of the spray nozzle of FIG. 16, rotated 90 degrees from FIG. 17;
 FIG. 19 is a top view of the spray nozzle of FIG. 16; and,
 FIG. 20 is a bottom view of the spray nozzle of FIG. 17.

1 Claim, 4 Drawing Sheets

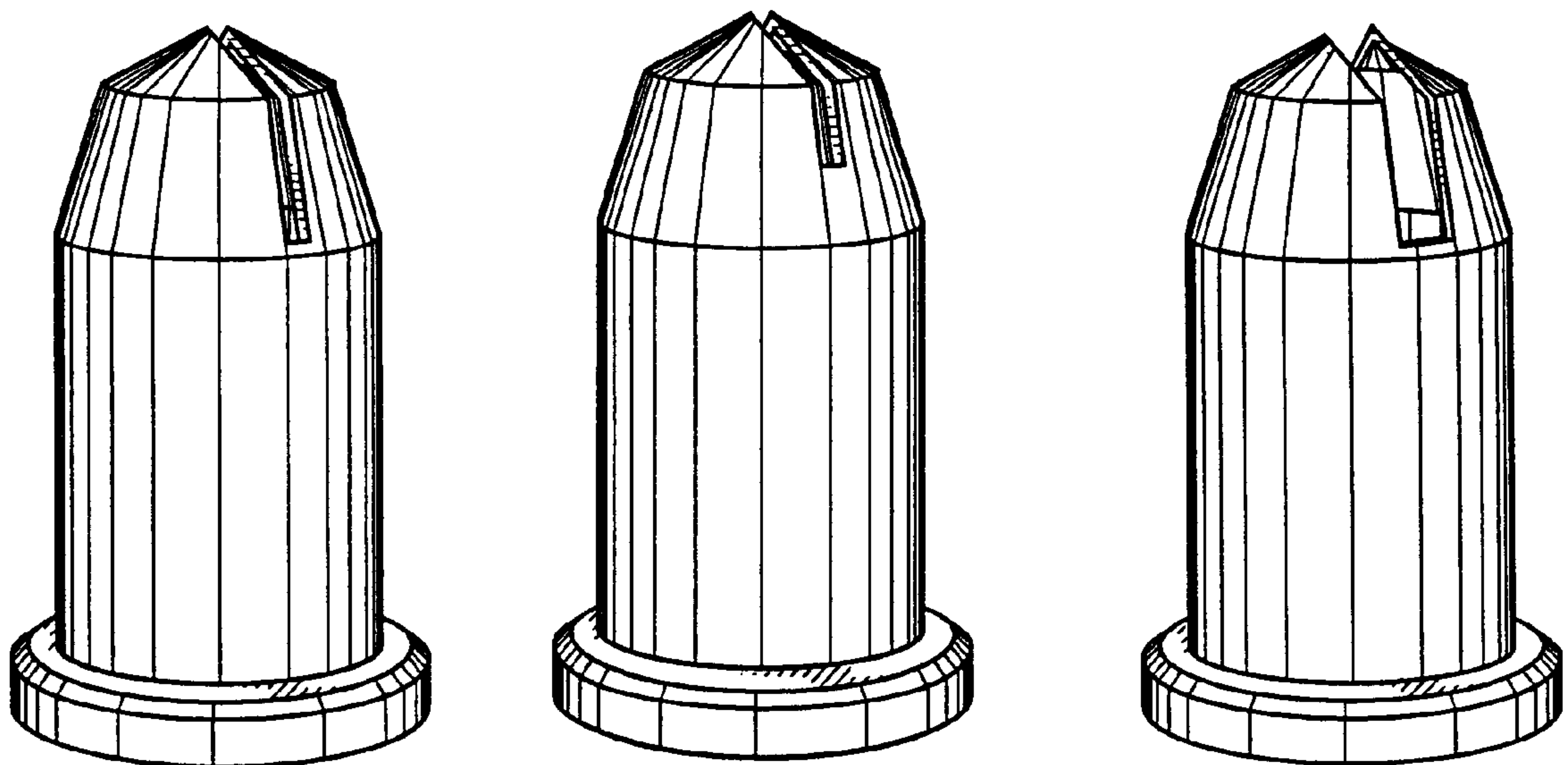

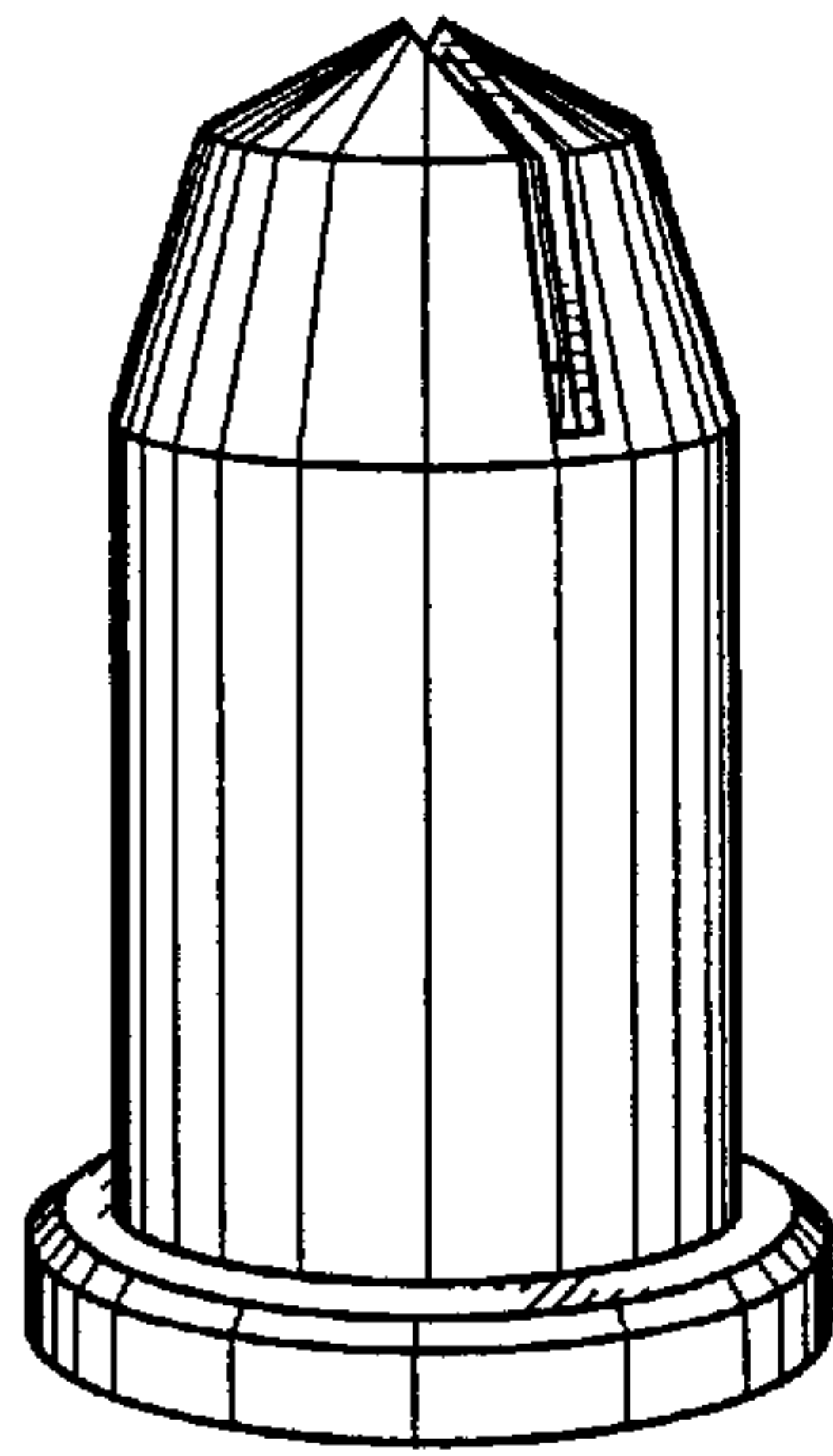

FIG. 1

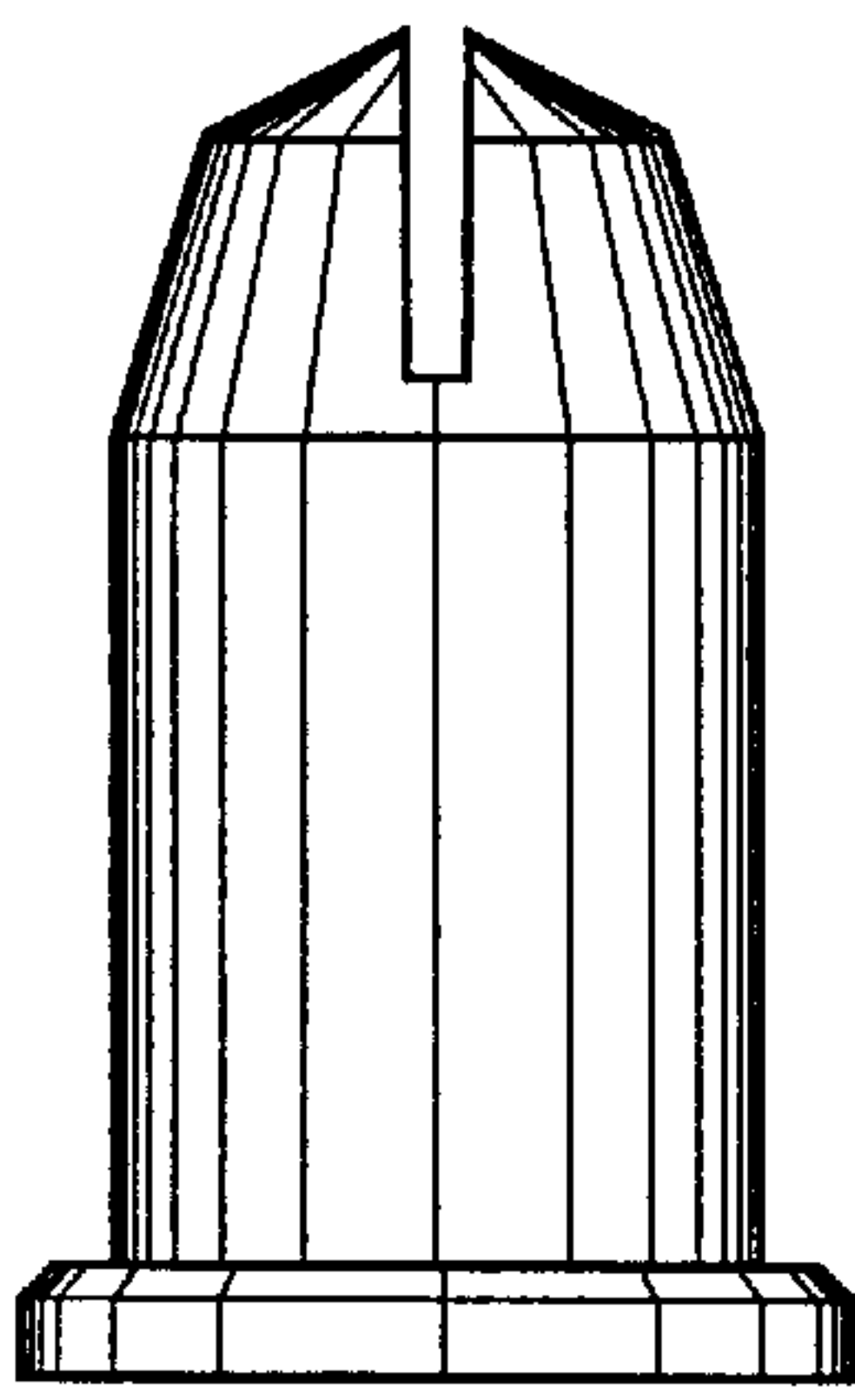

FIG. 2

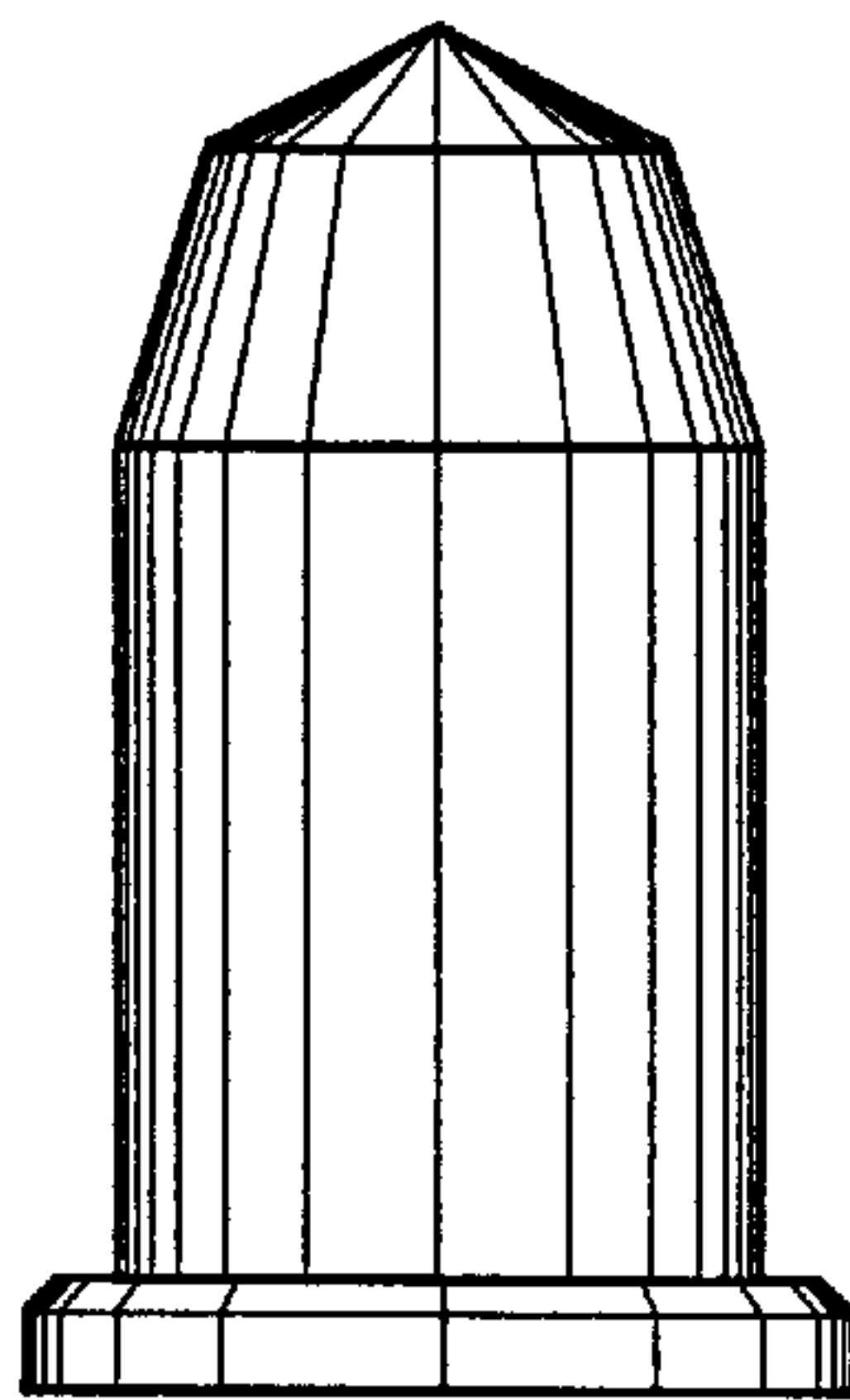

FIG. 3

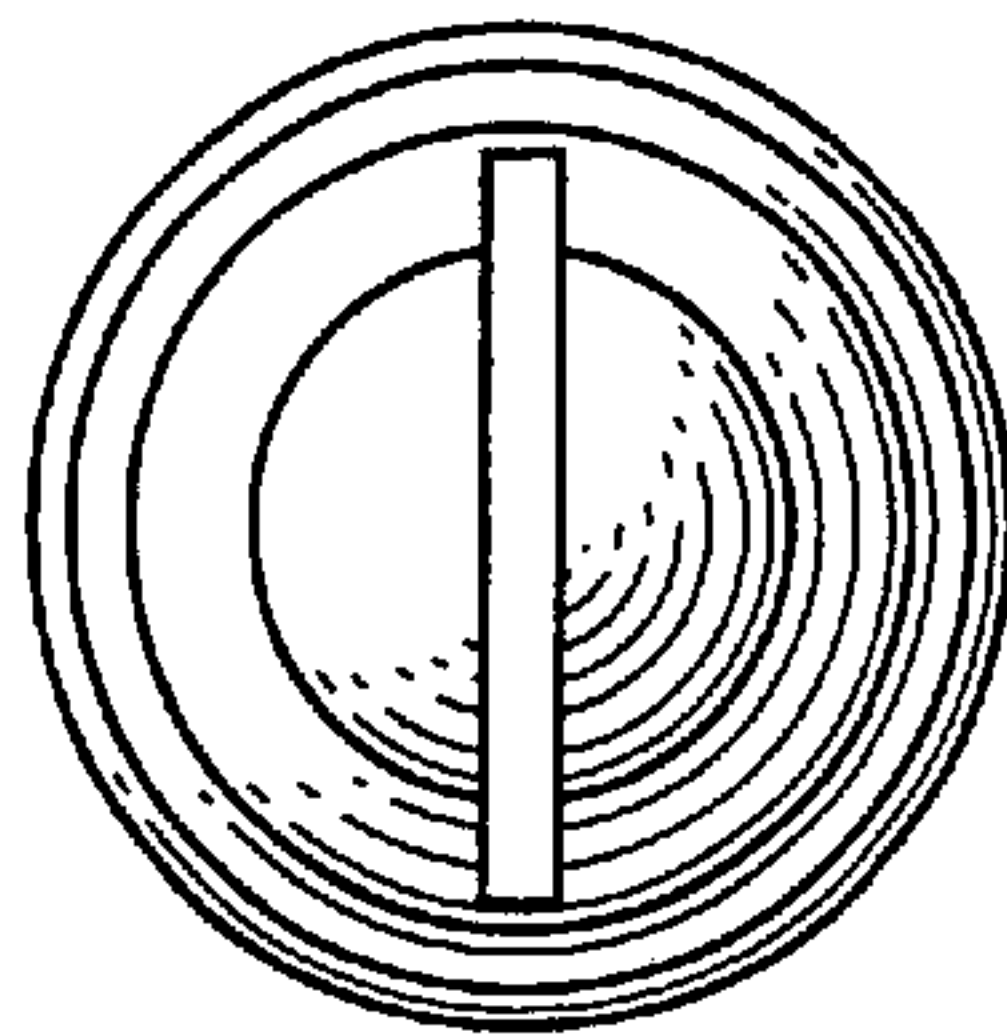

FIG. 4

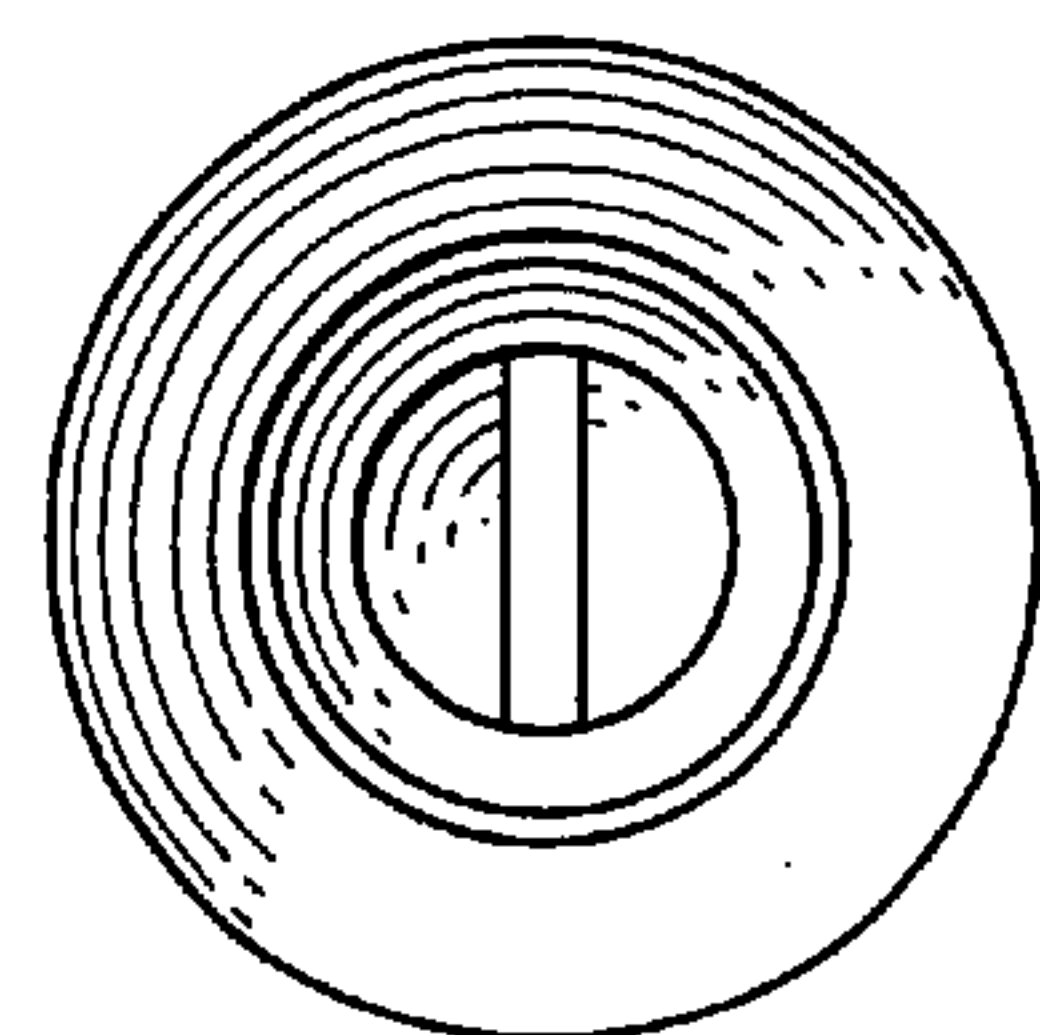

FIG. 5

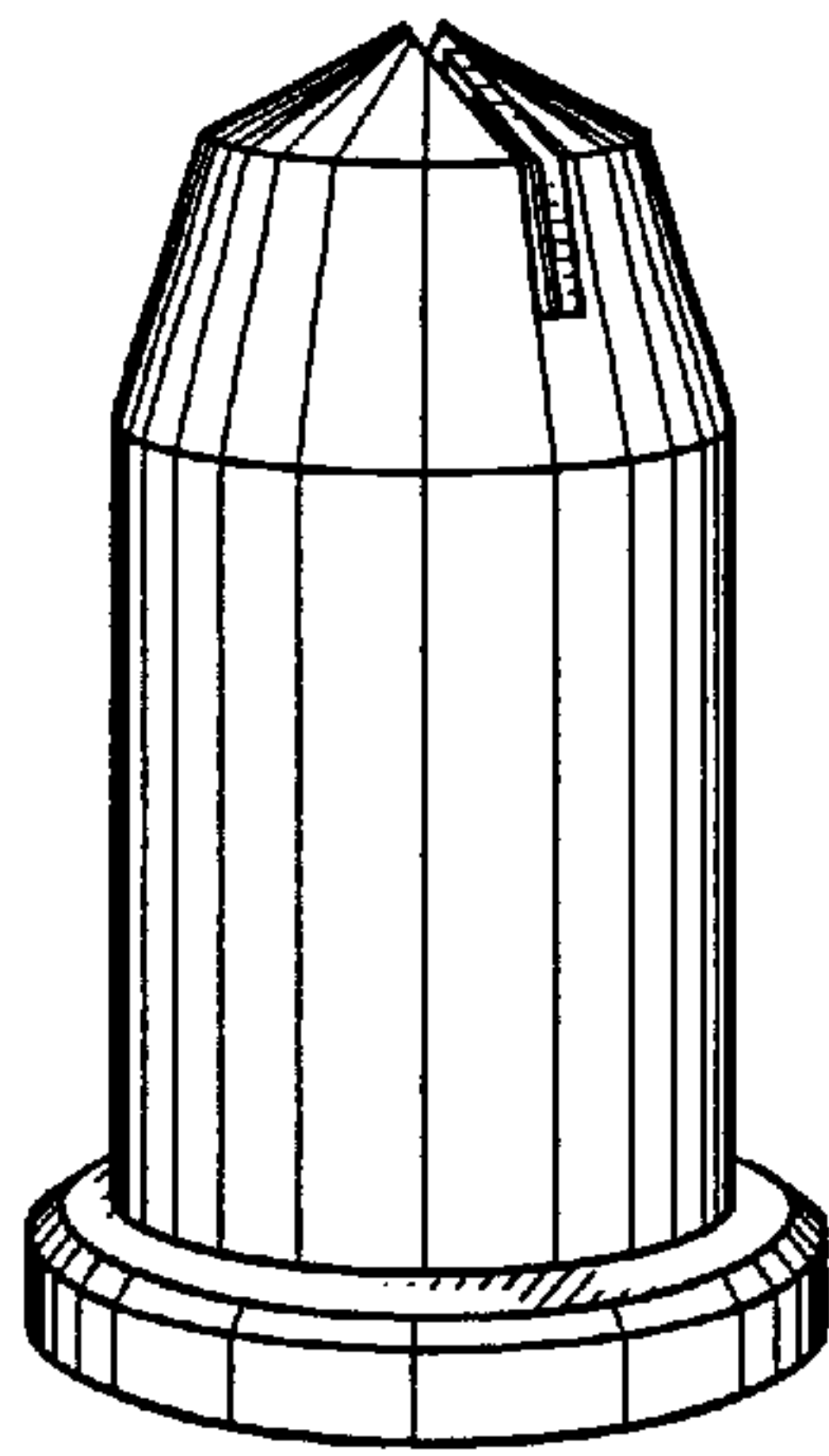

FIG. 6

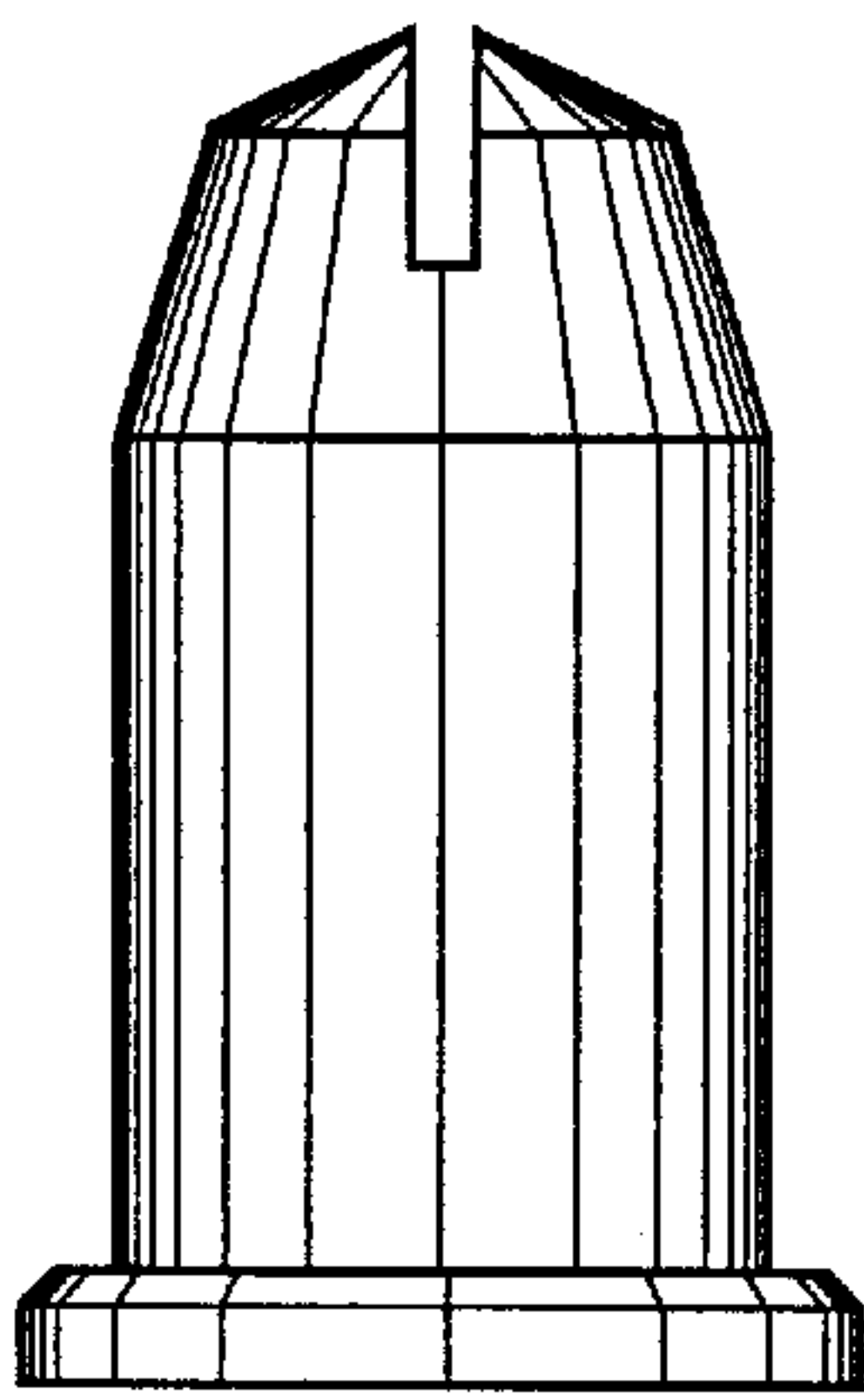

FIG. 7

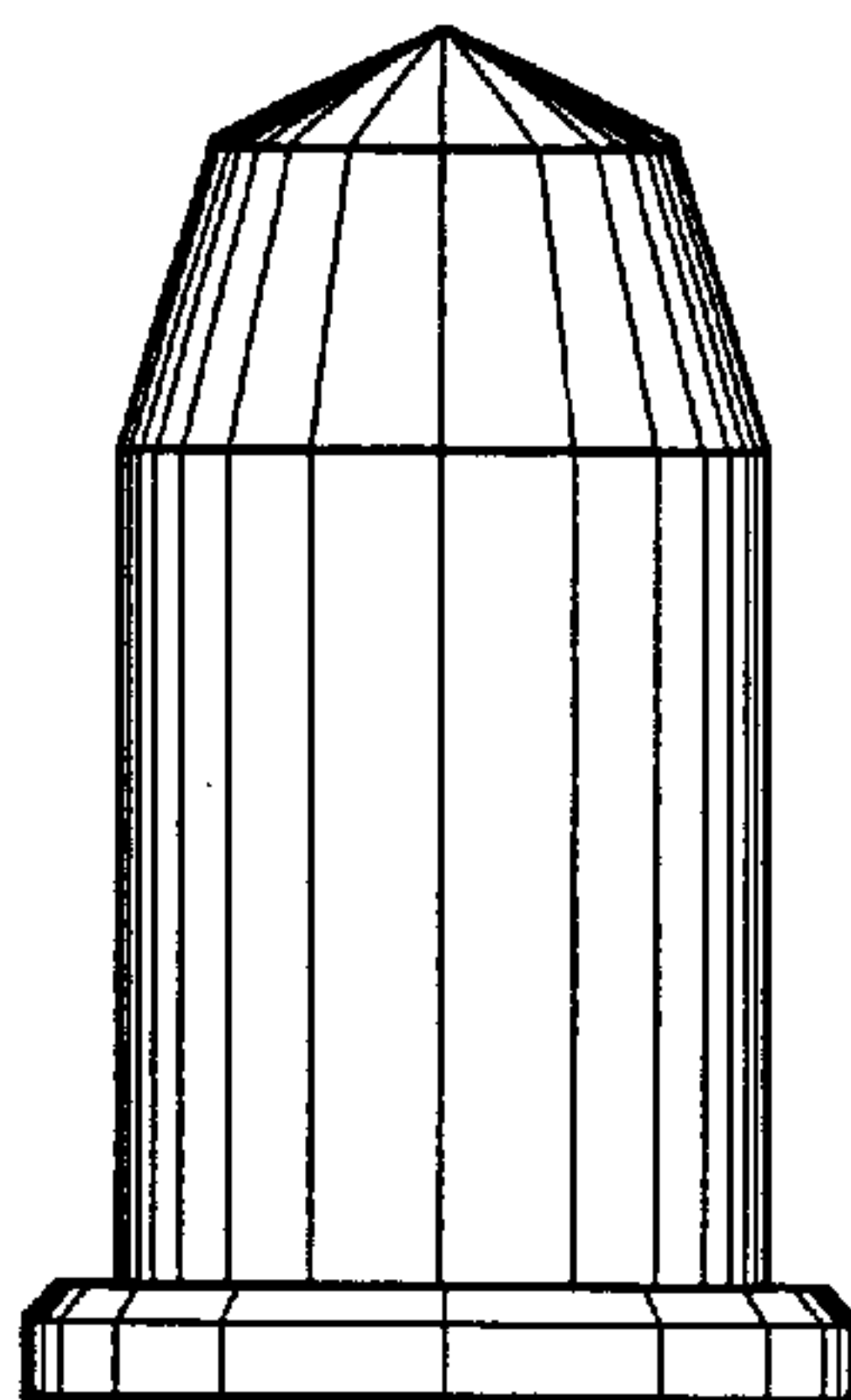

FIG. 8

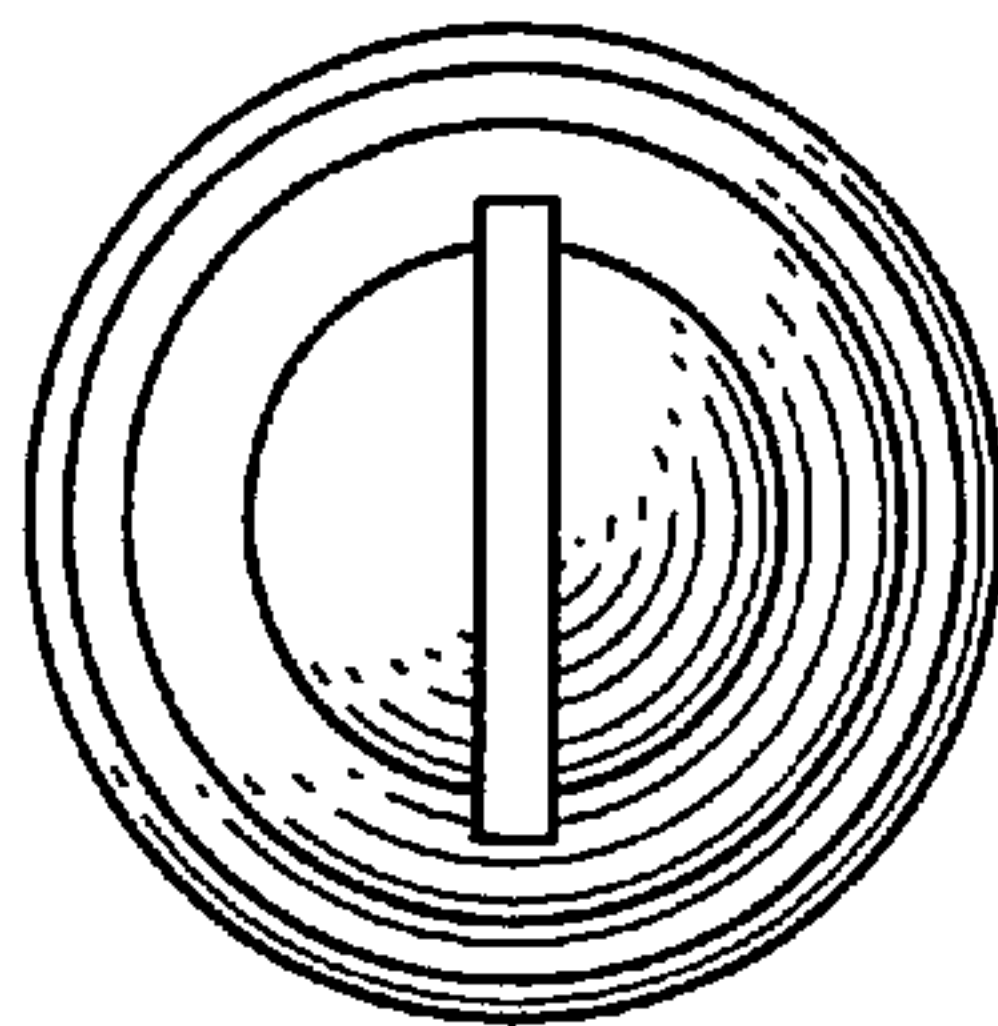

FIG. 9

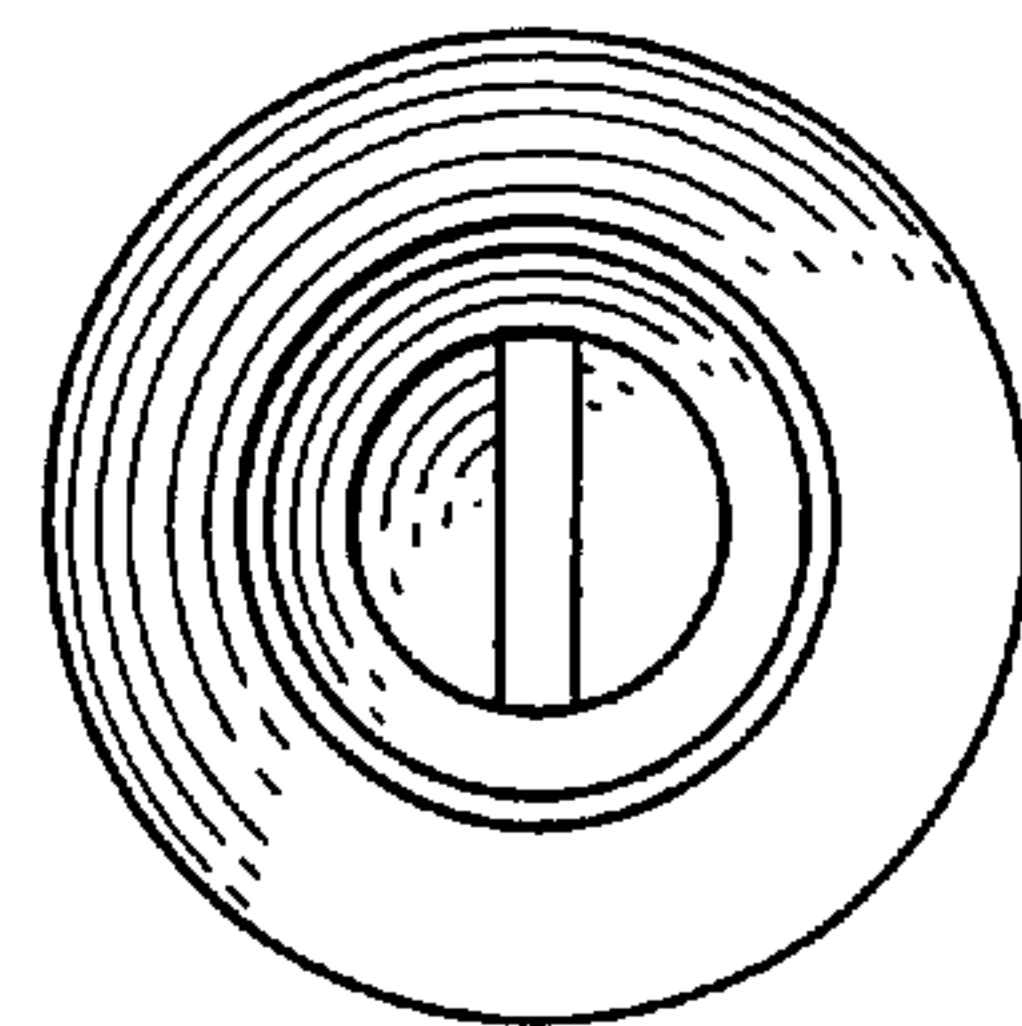

FIG. 10

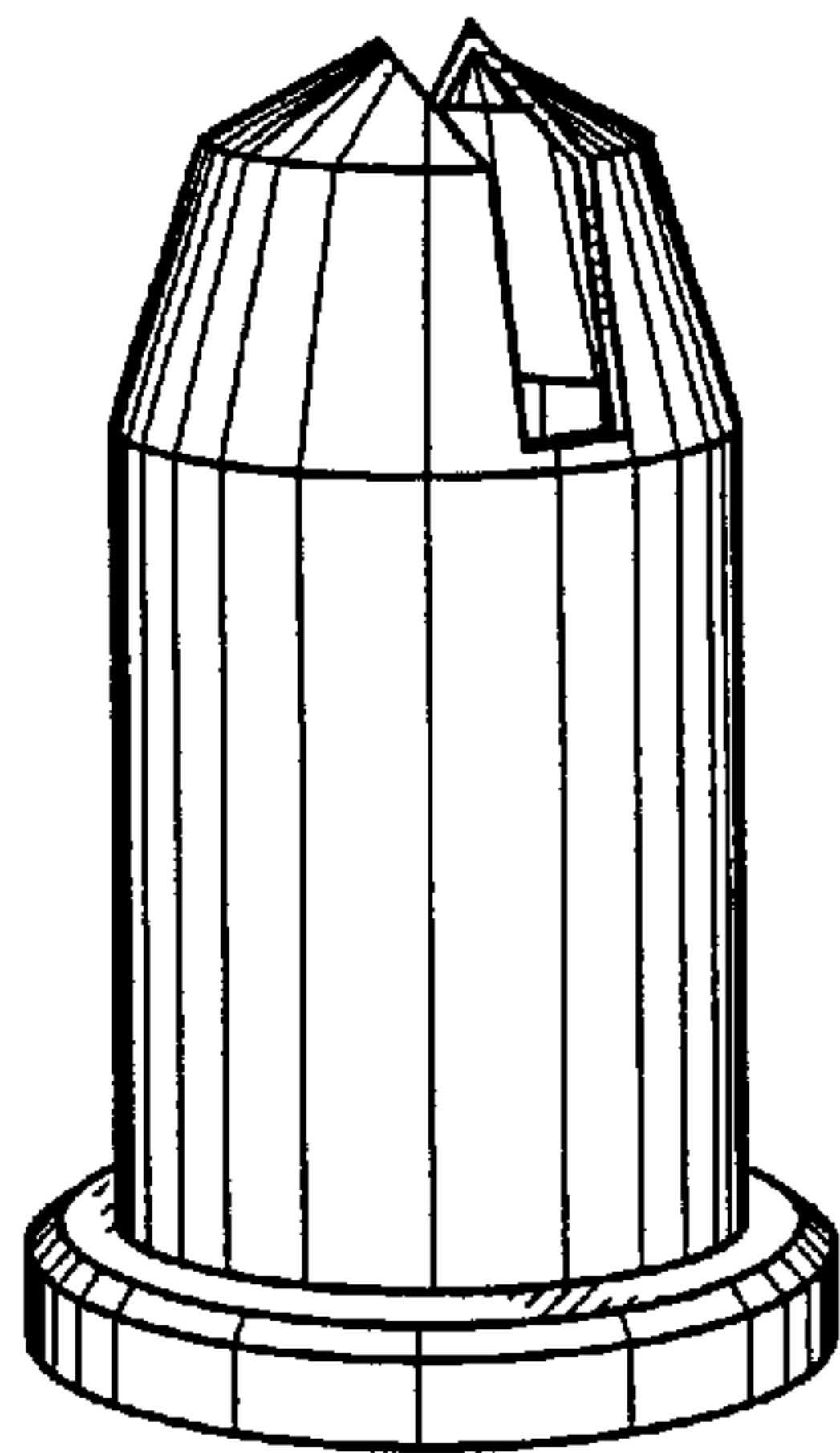

FIG. 11

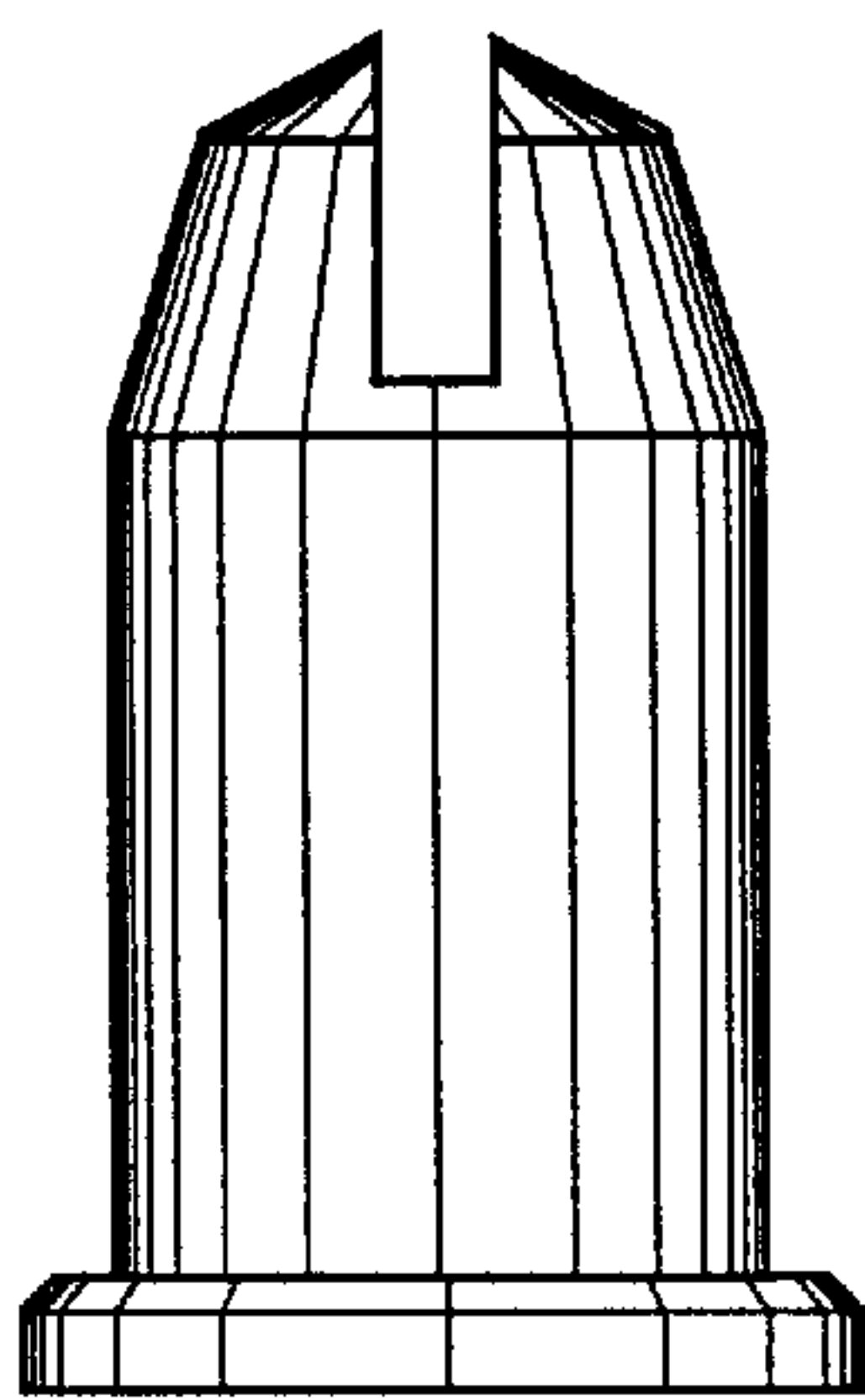

FIG. 12

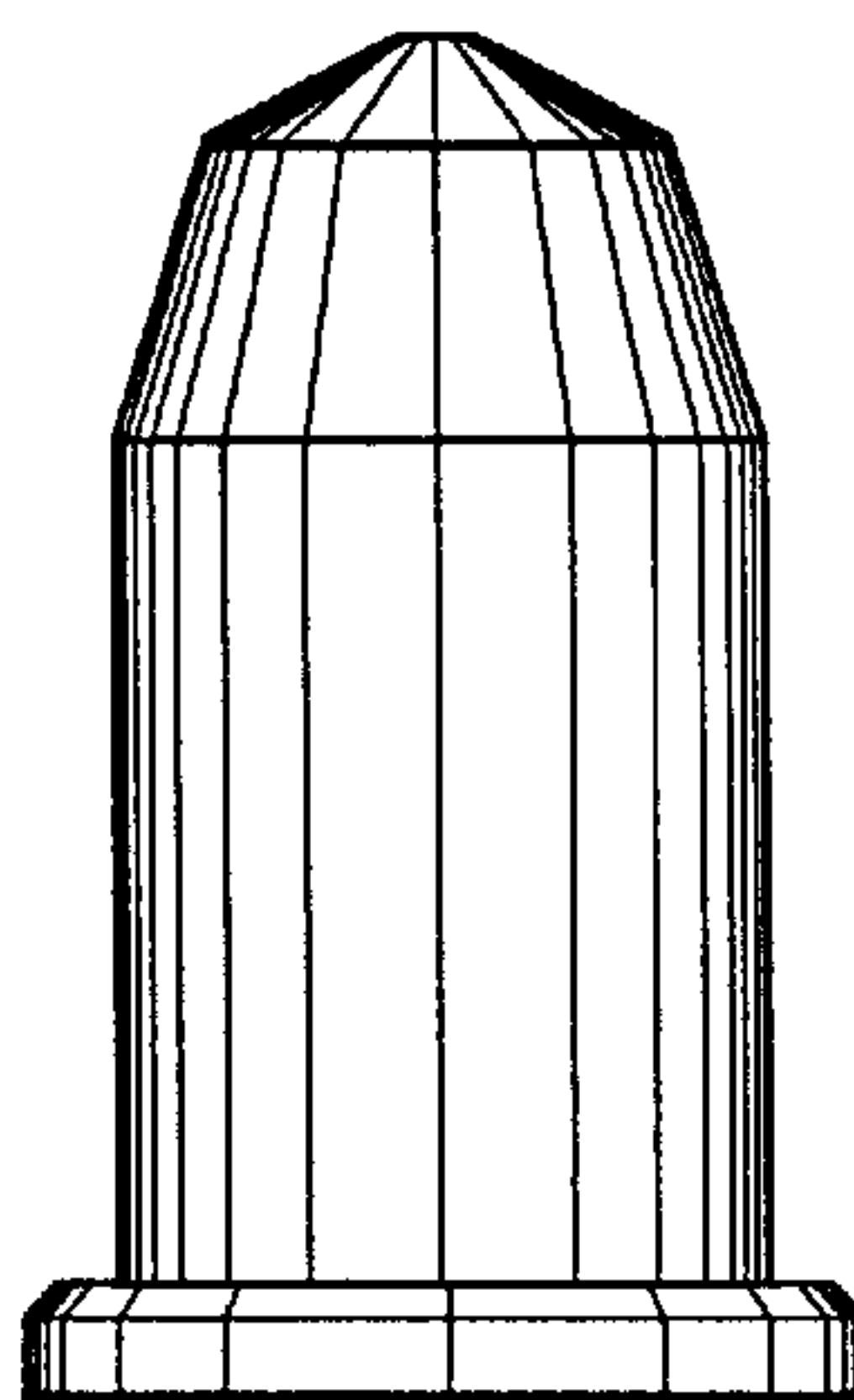

FIG. 13

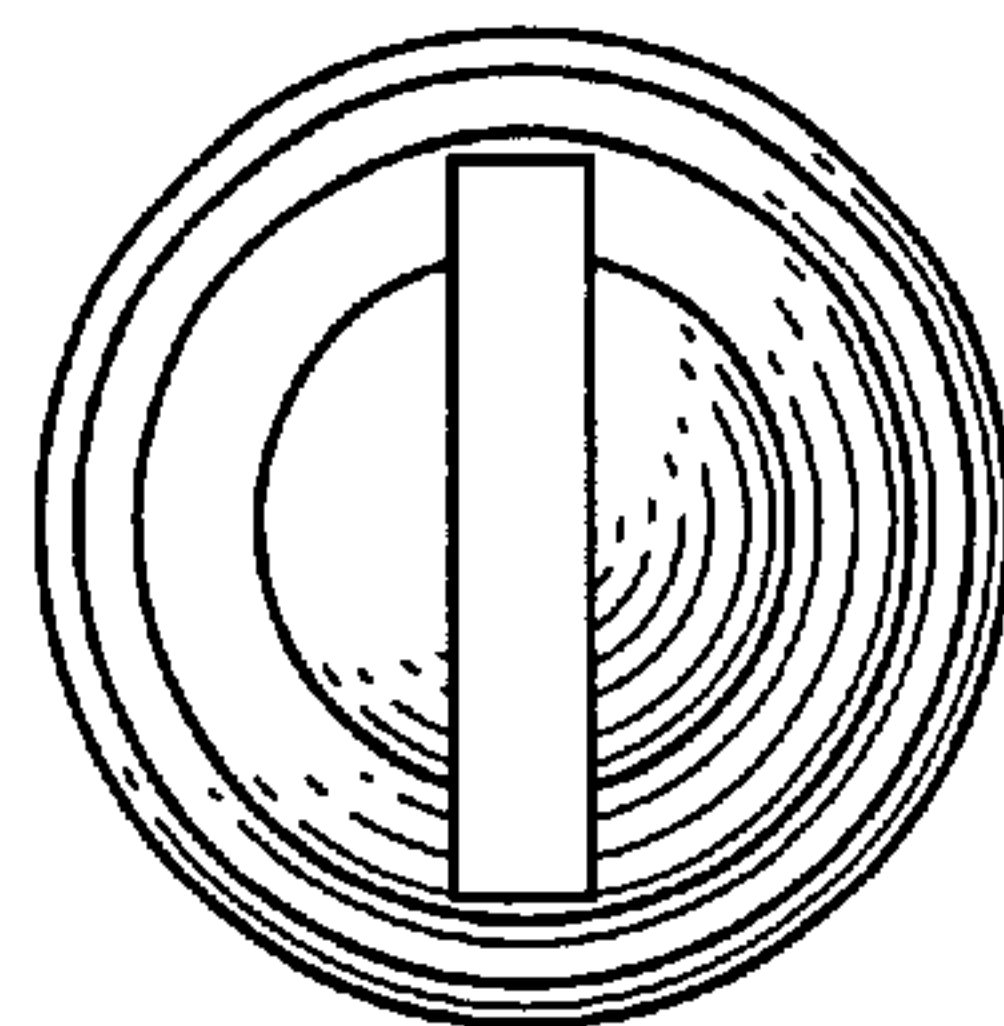

FIG. 14

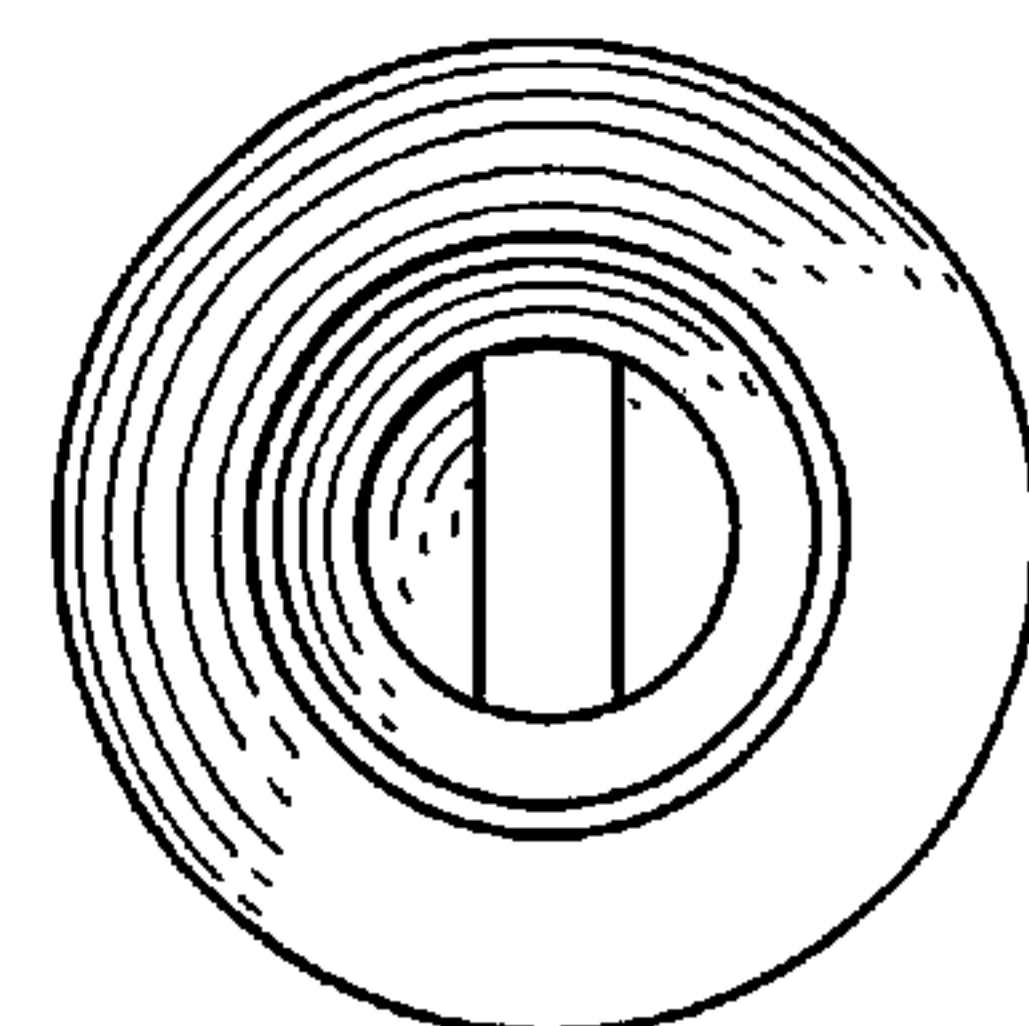

FIG. 15

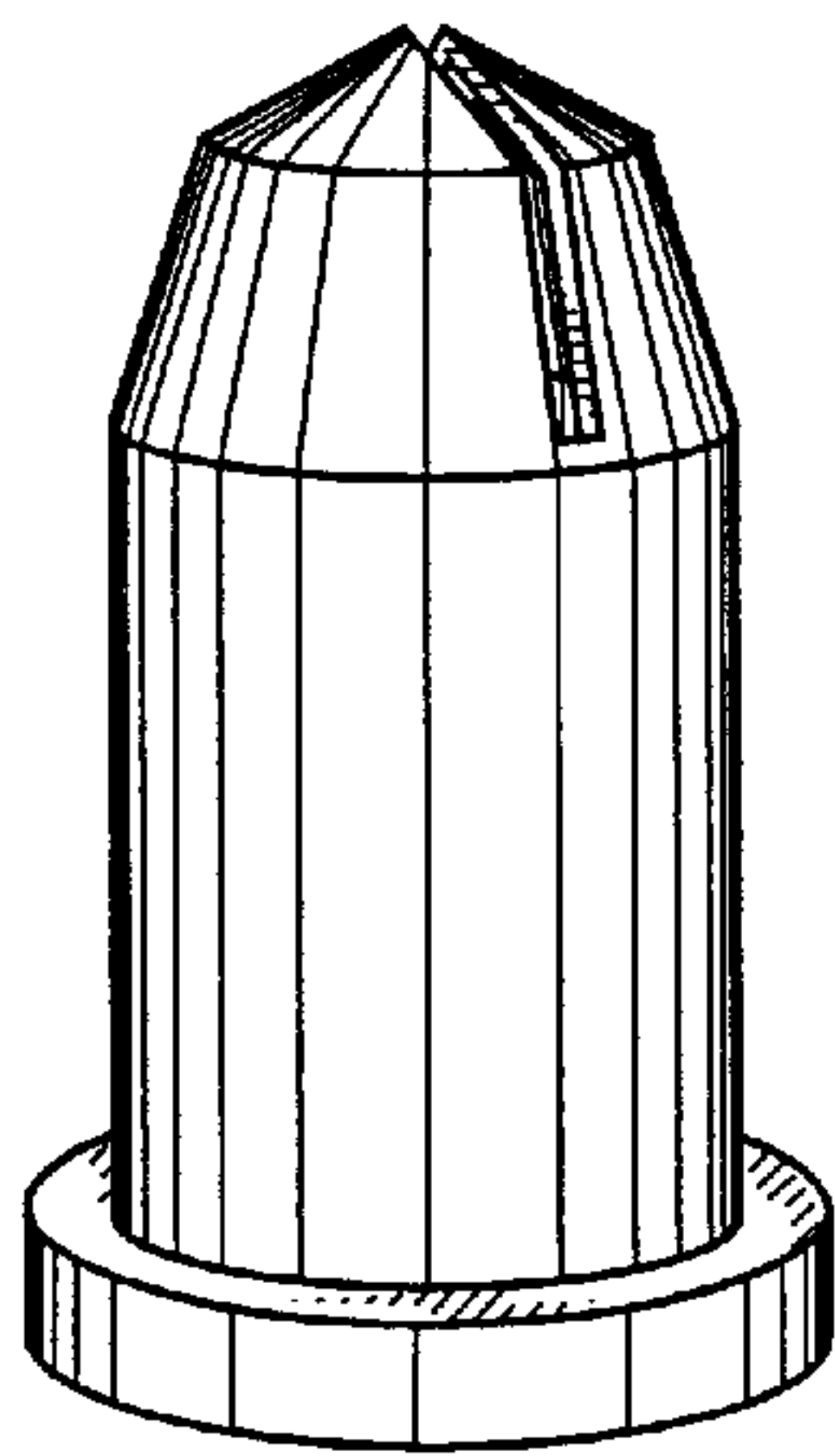

FIG. 16

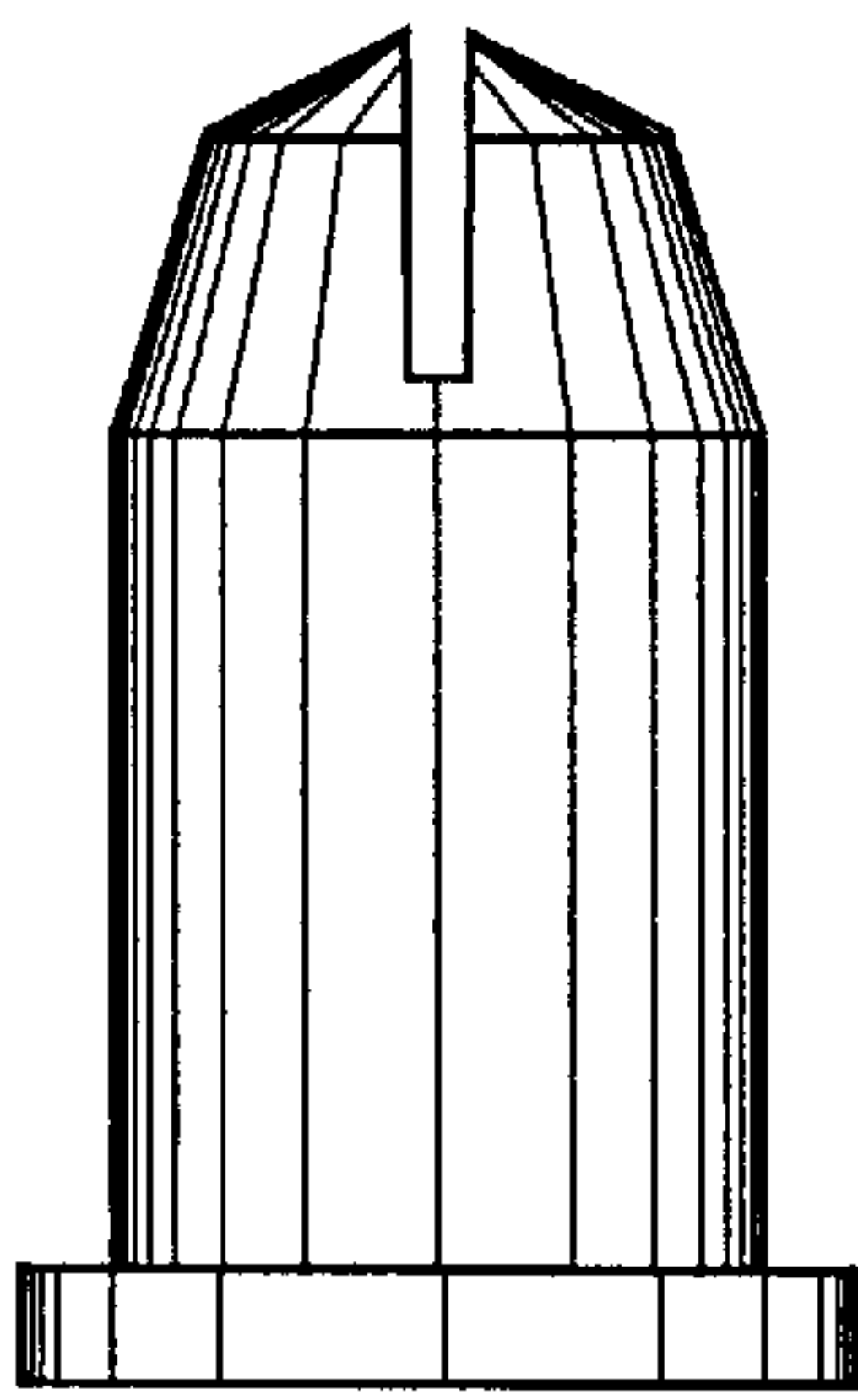

FIG. 17

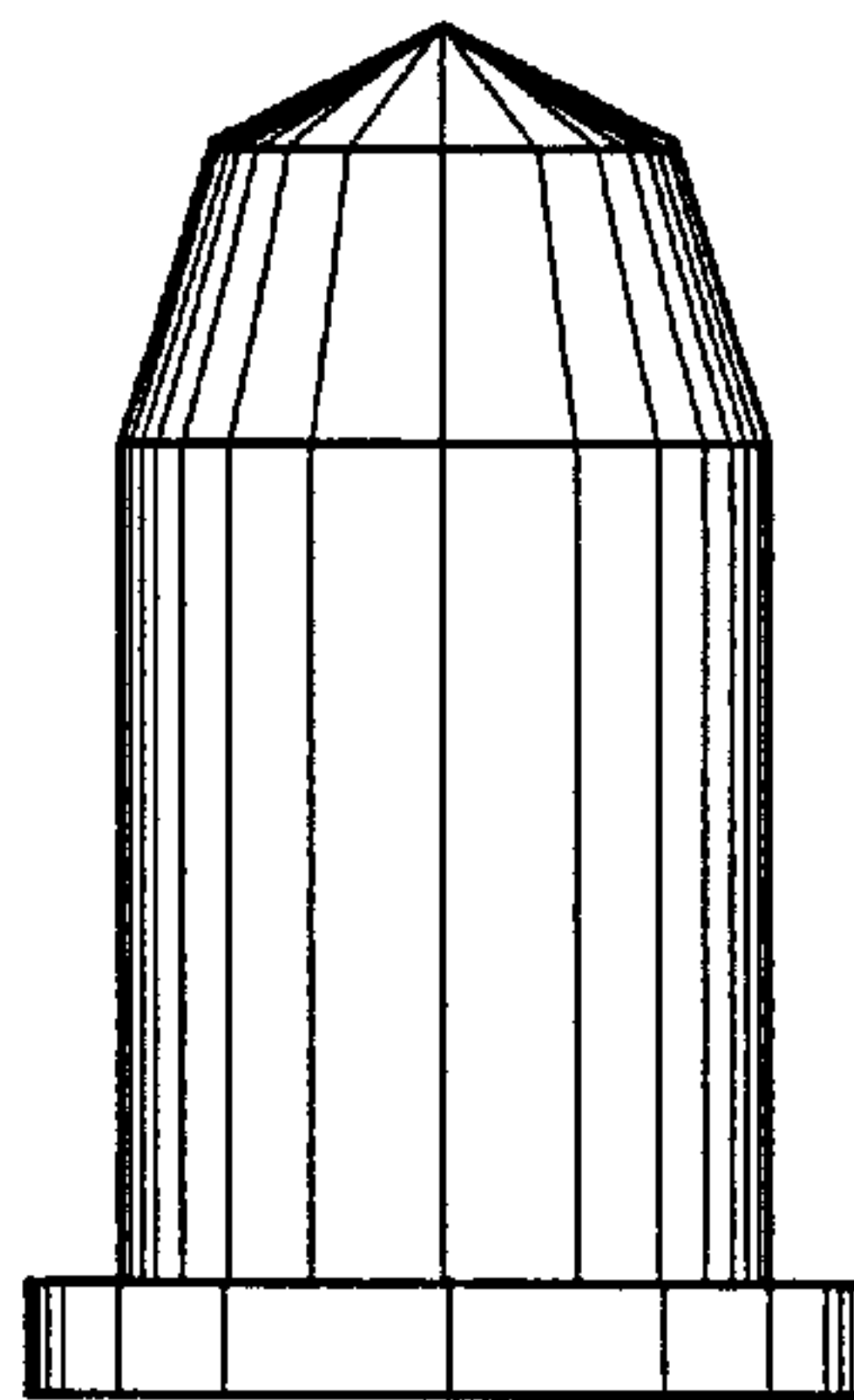

FIG. 18

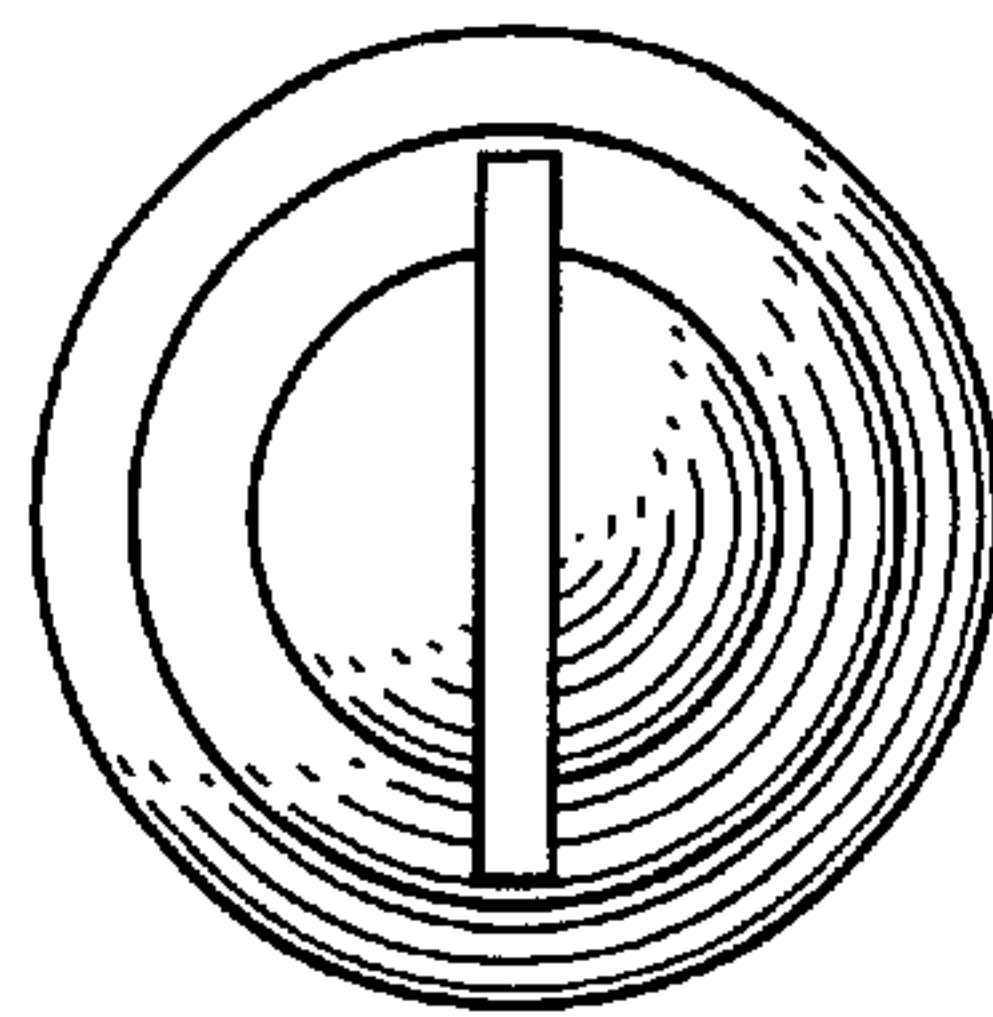

FIG. 19

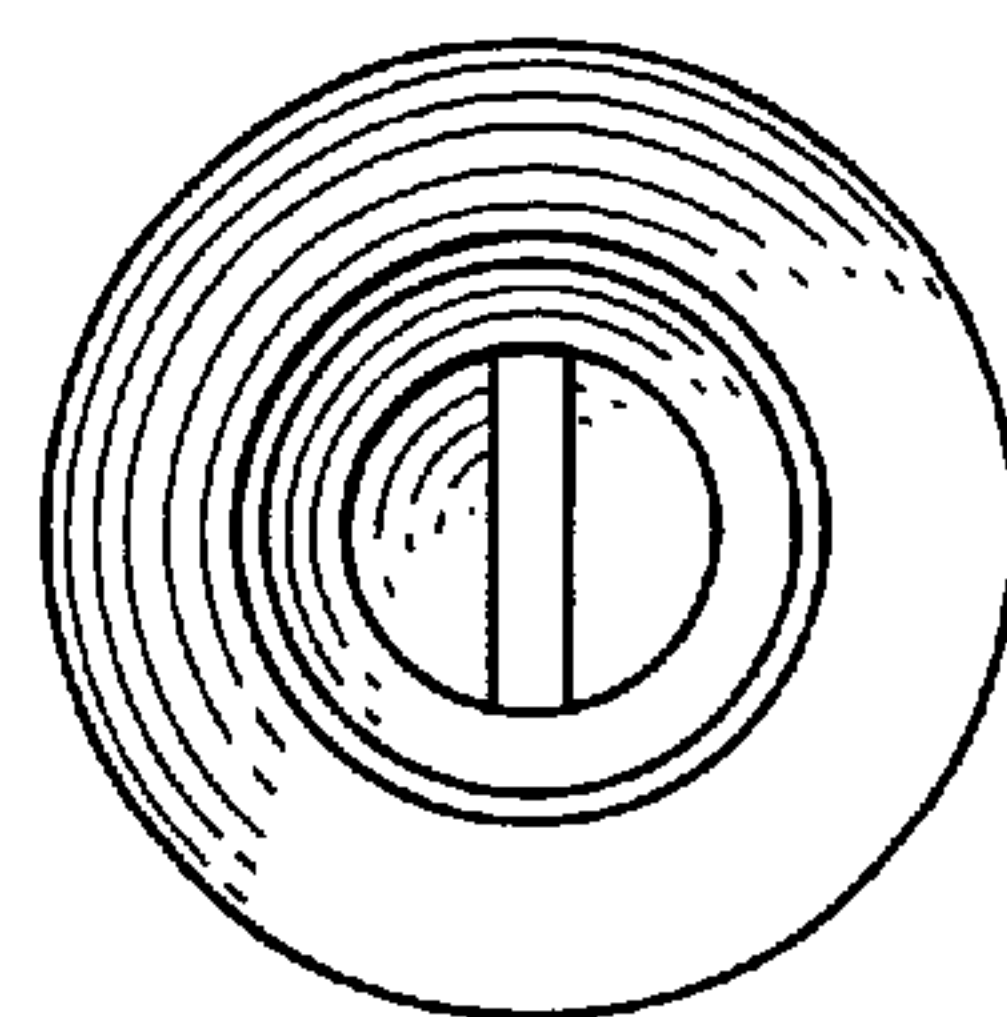

FIG. 20