



US00D462226S

(12) **United States Design Patent**
Williamson et al.

(10) **Patent No.:** **US D462,226 S**

(45) **Date of Patent:** **** Sep. 3, 2002**

(54) **COFFEE MAKER**

(75) Inventors: **Stephen C. Williamson**, Arvonian; **Mark K. Romandy**, Midlothian; **Joan M Gardiner**, Emporia; **Michael Garman**, Stafford; **Michael E. Smith**, Glen Allen, all of VA (US)

(73) Assignee: **Hamilton Beach/Proctor Silex, Inc.**, Glen Allen, VA (US)

(**) Term: **14 Years**

(21) Appl. No.: **29/143,019**

(22) Filed: **Jun. 7, 2001**

(51) **LOC (7) Cl.** **07-01**

(52) **U.S. Cl.** **D7/309; D7/310; D7/311**

(58) **Field of Search** **D7/305, 306, 309, D7/310, 311, 300; 99/282, 315, 310, 285, 299, 295; 200/83 F**

(56) **References Cited**

U.S. PATENT DOCUMENTS

3,759,161 A 9/1973 Anderson
D239,758 S 5/1976 Claxton

(List continued on next page.)

Primary Examiner—M. N. Pandozzi

(74) *Attorney, Agent, or Firm*—John H. Thomas, PC

(57) **CLAIM**

The ornamental design for coffee maker, as shown and described.

DESCRIPTION

FIG. 1 is a perspective view as seen from the top, front and left side of a coffee maker showing a preferred embodiment of the new design;

FIG. 2 is a left side elevational view thereof;

FIG. 3 is a front elevational view thereof;

FIG. 4 is a rear elevational view thereof;

FIG. 5 is a top plan view thereof;

FIG. 6 is a right side elevational view thereof;

FIG. 7 is a perspective view as seen from the top, front and left side of a coffee maker showing a second embodiment of the new design;

FIG. 8 is a left side elevational view of the coffee maker shown in FIG. 7;

FIG. 9 is a front elevational view of the coffee maker shown in FIG. 7;

FIG. 10 is a rear elevational view of the coffee maker shown in FIG. 7;

FIG. 11 is a top plan view of the coffee maker shown in FIG. 7;

FIG. 12 is a right side elevational view of the coffee maker shown in FIG. 7;

FIG. 13 is a perspective view as seen from the top, front and left side of a coffee maker showing a third embodiment of the new design;

FIG. 14 is a left side elevational view of the coffee maker shown in FIG. 13;

FIG. 15 is a front elevational view of the coffee maker shown in FIG. 13;

FIG. 16 is a rear elevational view of the coffee maker shown in FIG. 13;

FIG. 17 is a top plan view of the coffee maker shown in FIG. 13;

FIG. 18 is a right side elevational view of the coffee maker shown in FIG. 13;

FIG. 19 is a perspective view as seen from the top, front and left side of a coffee maker showing a fourth embodiment of the new design;

FIG. 20 is a left side elevational view of the coffee maker shown in FIG. 19;

FIG. 21 is a front elevational view of the coffee maker shown in FIG. 19;

FIG. 22 is a rear elevational view of the coffee maker shown in FIG. 19;

FIG. 23 is a top plan view of the coffee maker shown in FIG. 19; and,

FIG. 24 is a right side elevational view of the coffee maker shown in FIG. 19.

1 Claim, 20 Drawing Sheets

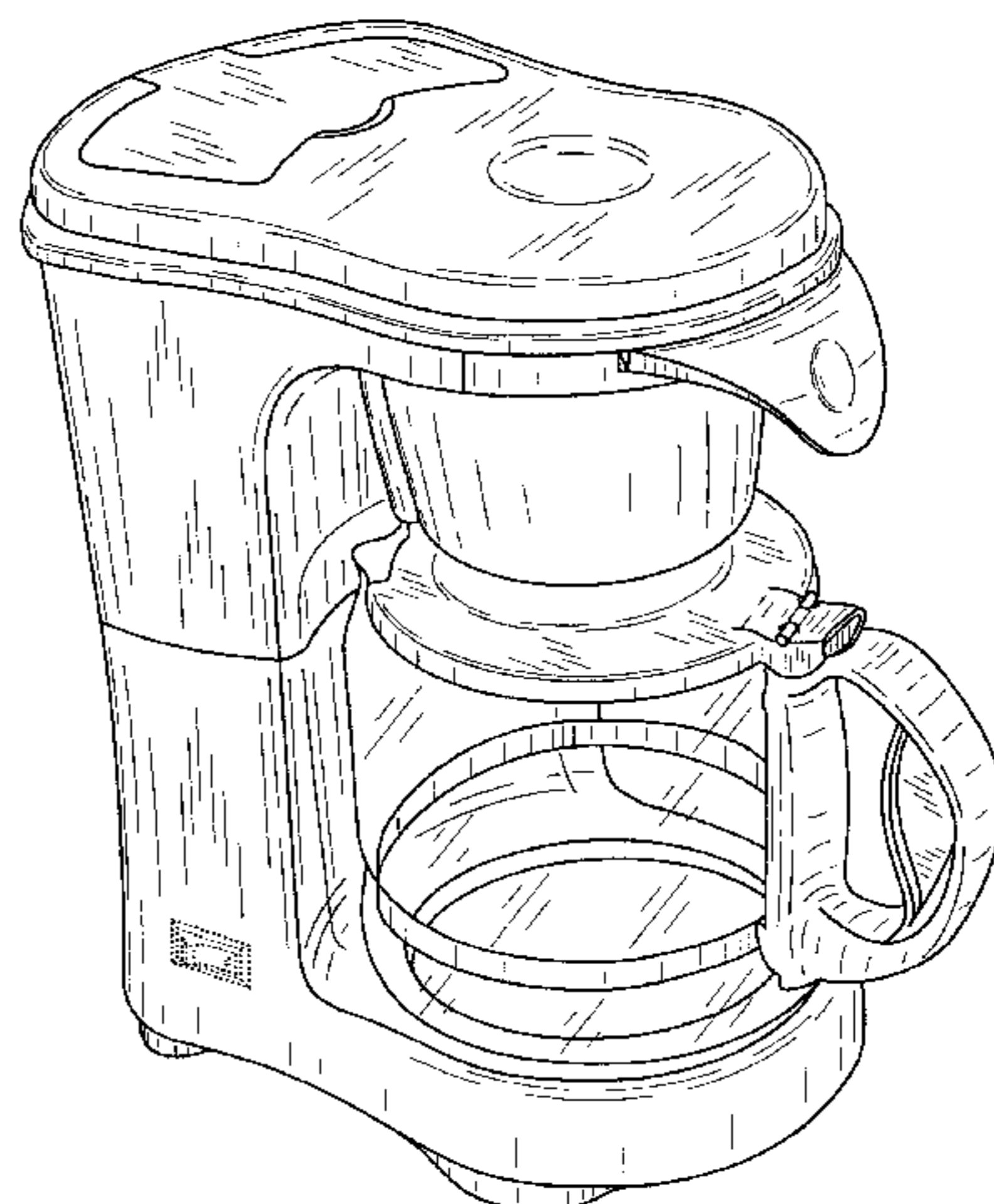
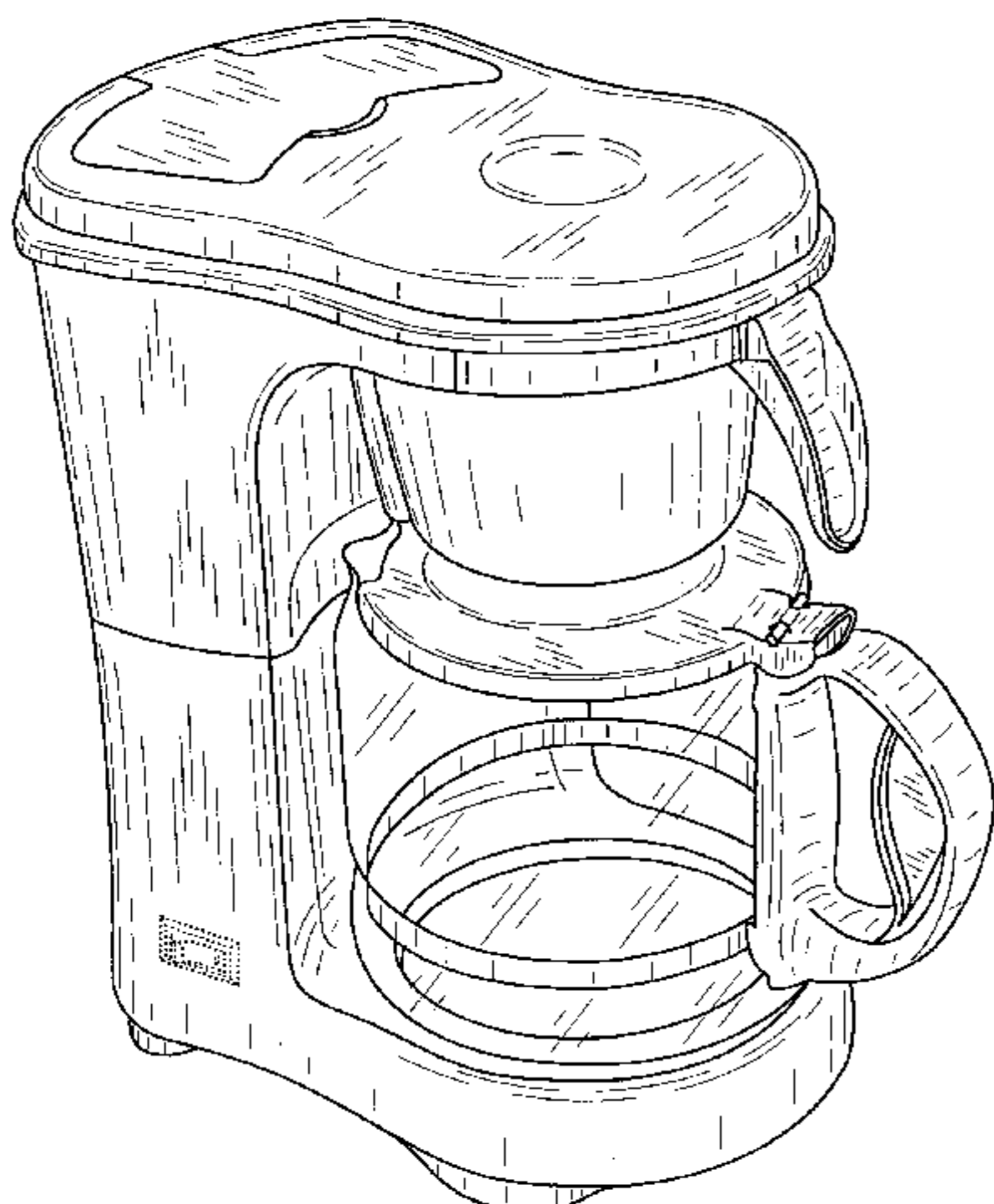

US D462,226 S

Page 2

U.S. PATENT DOCUMENTS

D241,219 S	8/1976	Martin		D386,039 S	11/1997	Dingelstad	
D248,720 S *	8/1978	Sato et al.	D7/309	D386,944 S	12/1997	Demore et al.	
D248,721 S *	8/1978	Sato et al.	D7/309	D387,946 S	12/1997	Hippen	
D255,120 S	5/1980	Bardeau		D401,108 S	11/1998	Pochopien et al.	
D257,475 S	11/1980	von der Luehe		D403,198 S	12/1998	DeMars	
D288,517 S	3/1987	Kahlcke		D403,199 S	12/1998	Micoley	
D290,216 S *	6/1987	Precht	D7/309	D404,604 S	1/1999	Pochopien et al.	
D291,525 S *	8/1987	Classen	D7/309	D404,961 S	2/1999	Carrere	
D296,971 S	8/1988	Stutzer		D407,262 S	3/1999	Dingelstad	
D299,608 S	1/1989	Knochner		D407,593 S	4/1999	Hu et al.	
D300,596 S *	4/1989	Eugster	D7/309	D407,596 S	4/1999	Hsu	
4,889,041 A	12/1989	Mahlich et al.		D408,208 S	4/1999	Hsu	
4,920,868 A *	5/1990	Gehrmann	99/279	D408,680 S	4/1999	Lin	
4,969,392 A	11/1990	Steele et al.		D411,705 S	6/1999	Littmann	
D314,881 S	2/1991	Wundergem et al.		D413,479 S	9/1999	Mork et al.	
D326,386 S *	5/1992	Rakocy et al.	D7/309	5,964,141 A	10/1999	Andrew et al.	
D329,160 S *	9/1992	Choi	D7/309	D418,357 S	1/2000	Lin	
D336,207 S	6/1993	Brookshire		D421,360 S	3/2000	Lin	
D339,954 S	10/1993	Bunn et al.		D424,360 S	5/2000	Schwarz et al.	
5,251,541 A	10/1993	Anson et al.		D439,103 S *	3/2001	Cruz	D7/309
D343,758 S	2/1994	Beeren		D446,989 S *	8/2001	Cruz	D7/309
D346,298 S	4/1994	Brady et al.		D453,656 S *	2/2002	Byler et al.	D7/309
D360,333 S *	7/1995	Wai	D7/309	D454,023 S *	3/2002	Wang	D7/309
5,503,060 A	4/1996	Morecroft et al.		D454,466 S *	3/2002	Hong	D7/309
D376,950 S	12/1996	Saltet					

* cited by examiner

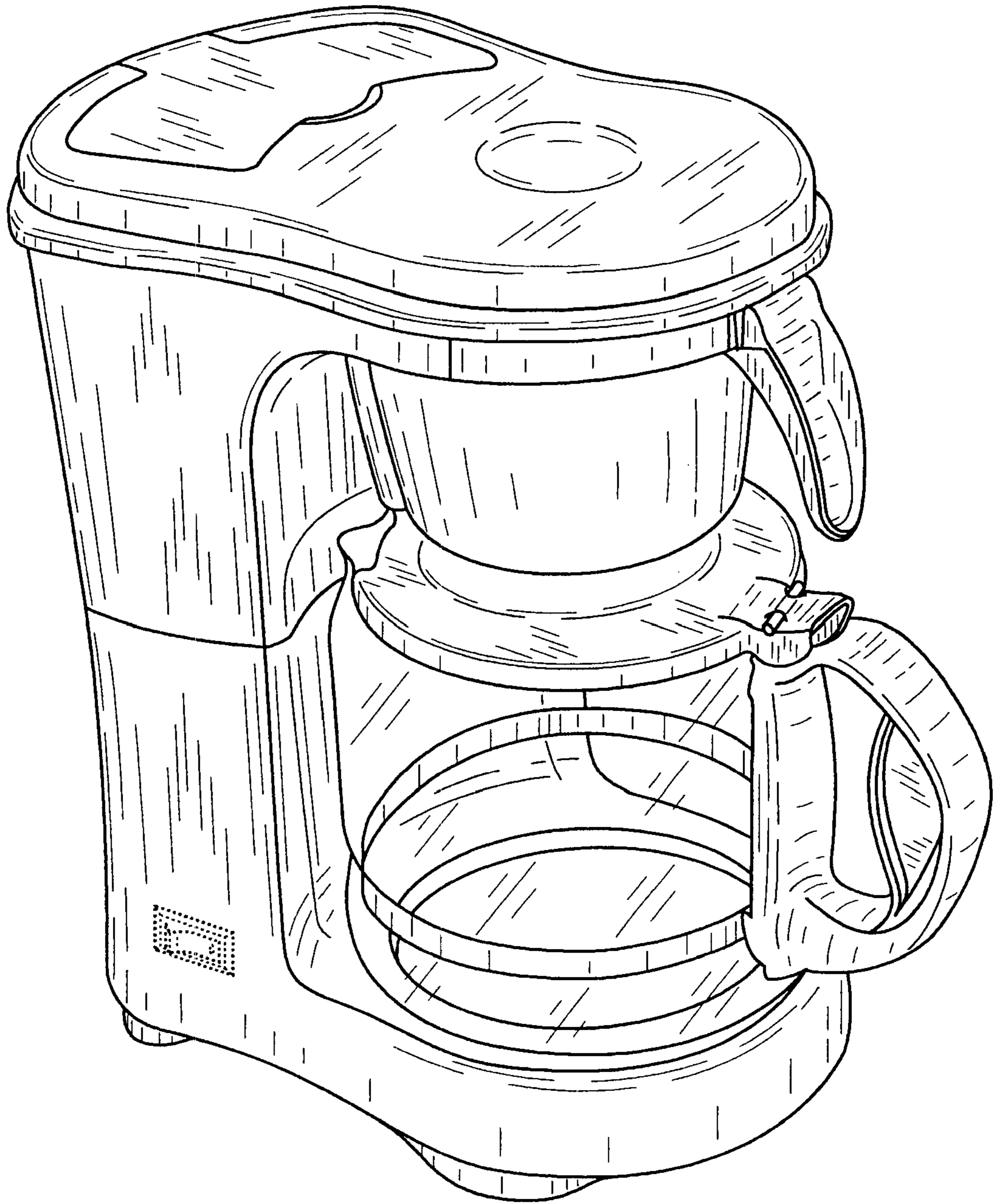

FIG. 1

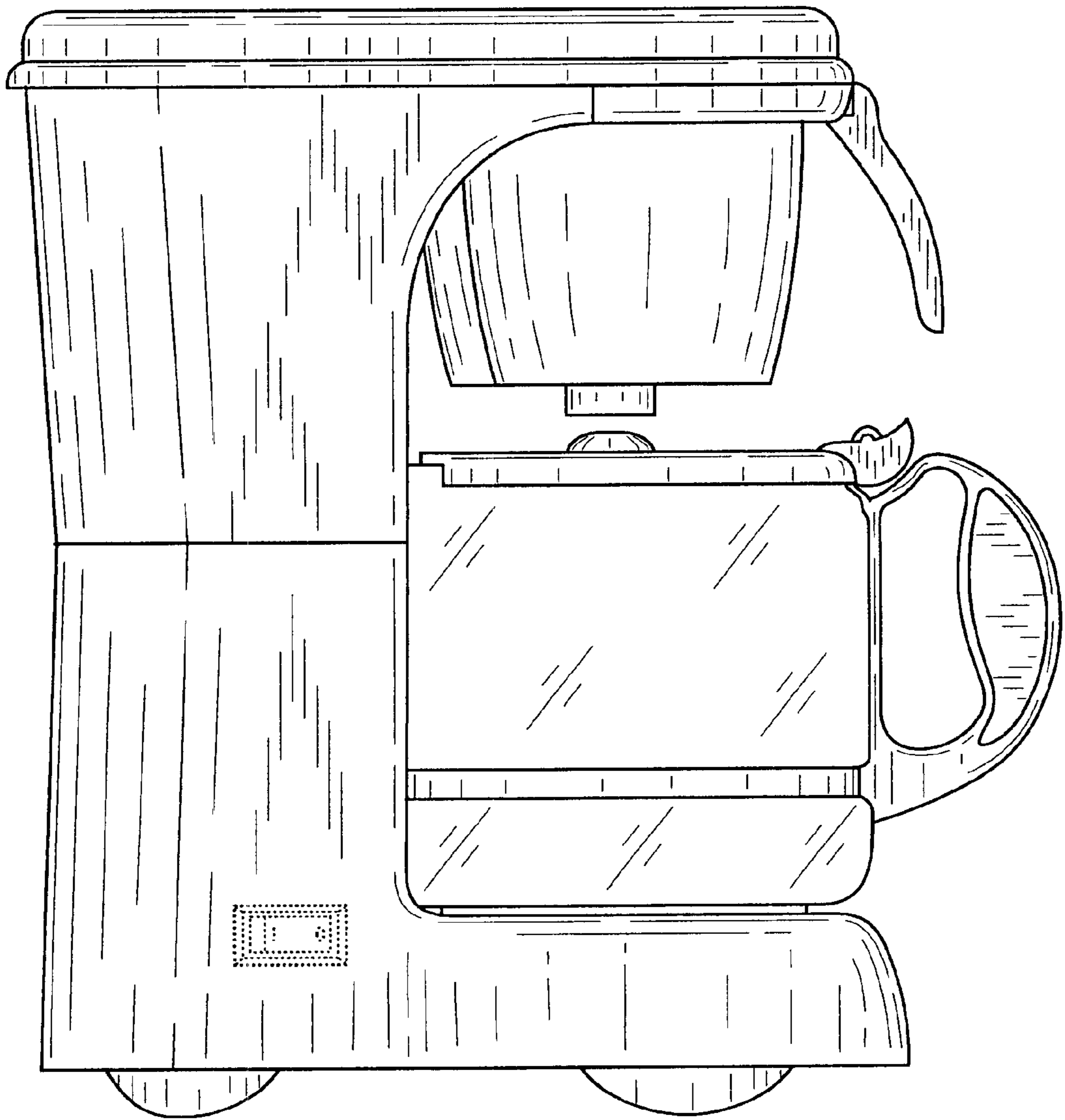

FIG. 2

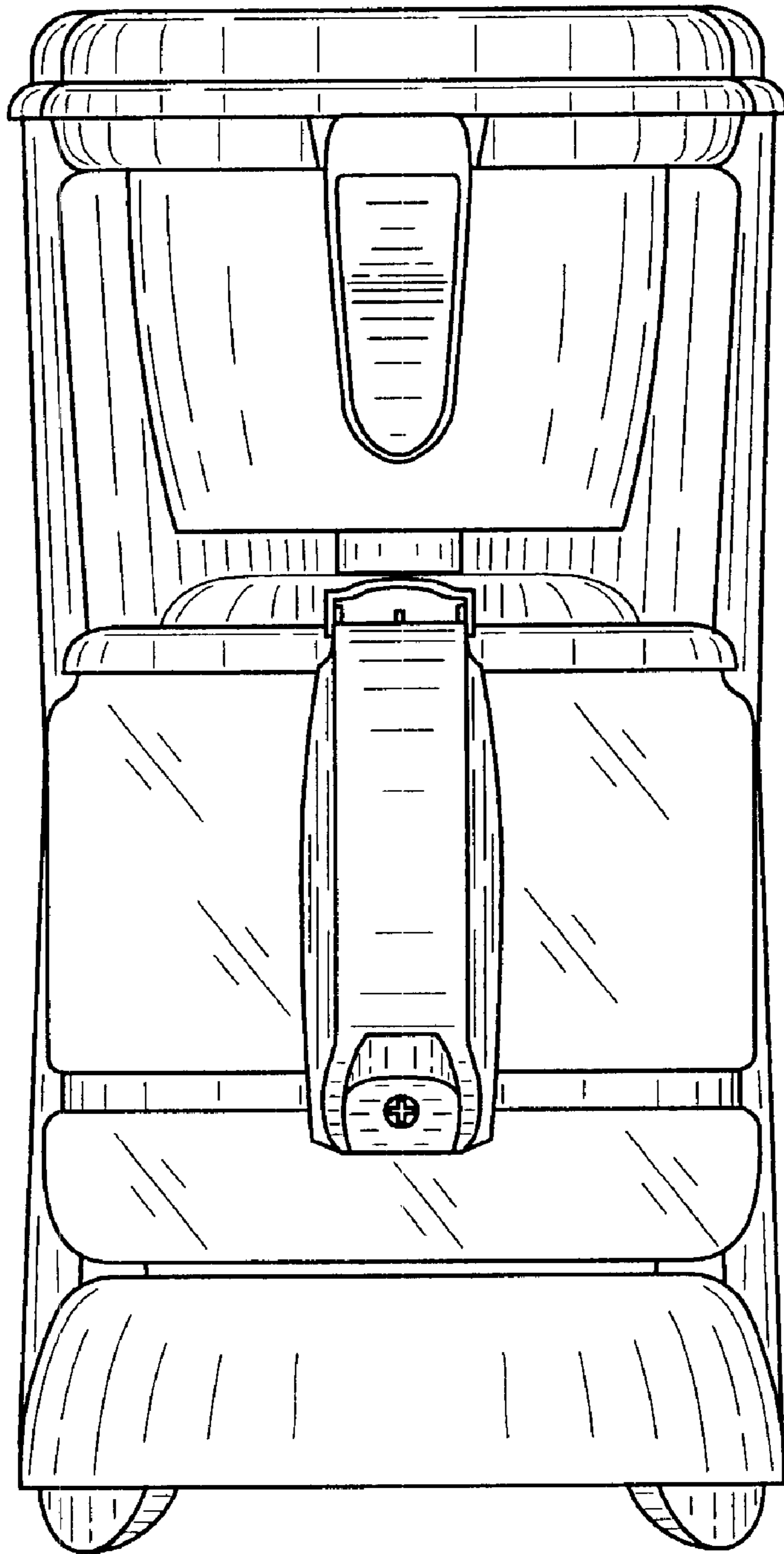

FIG. 3

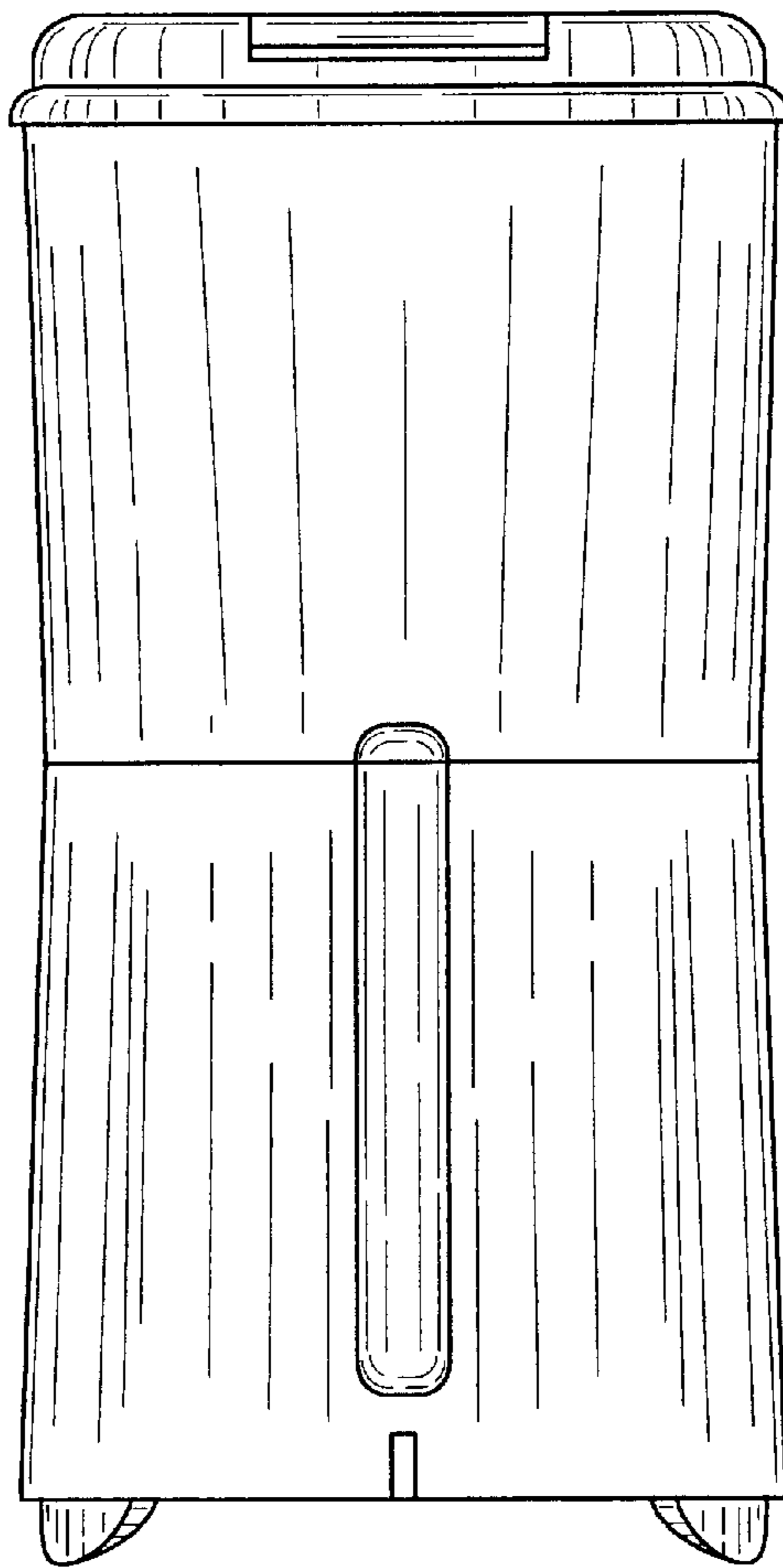

FIG. 4

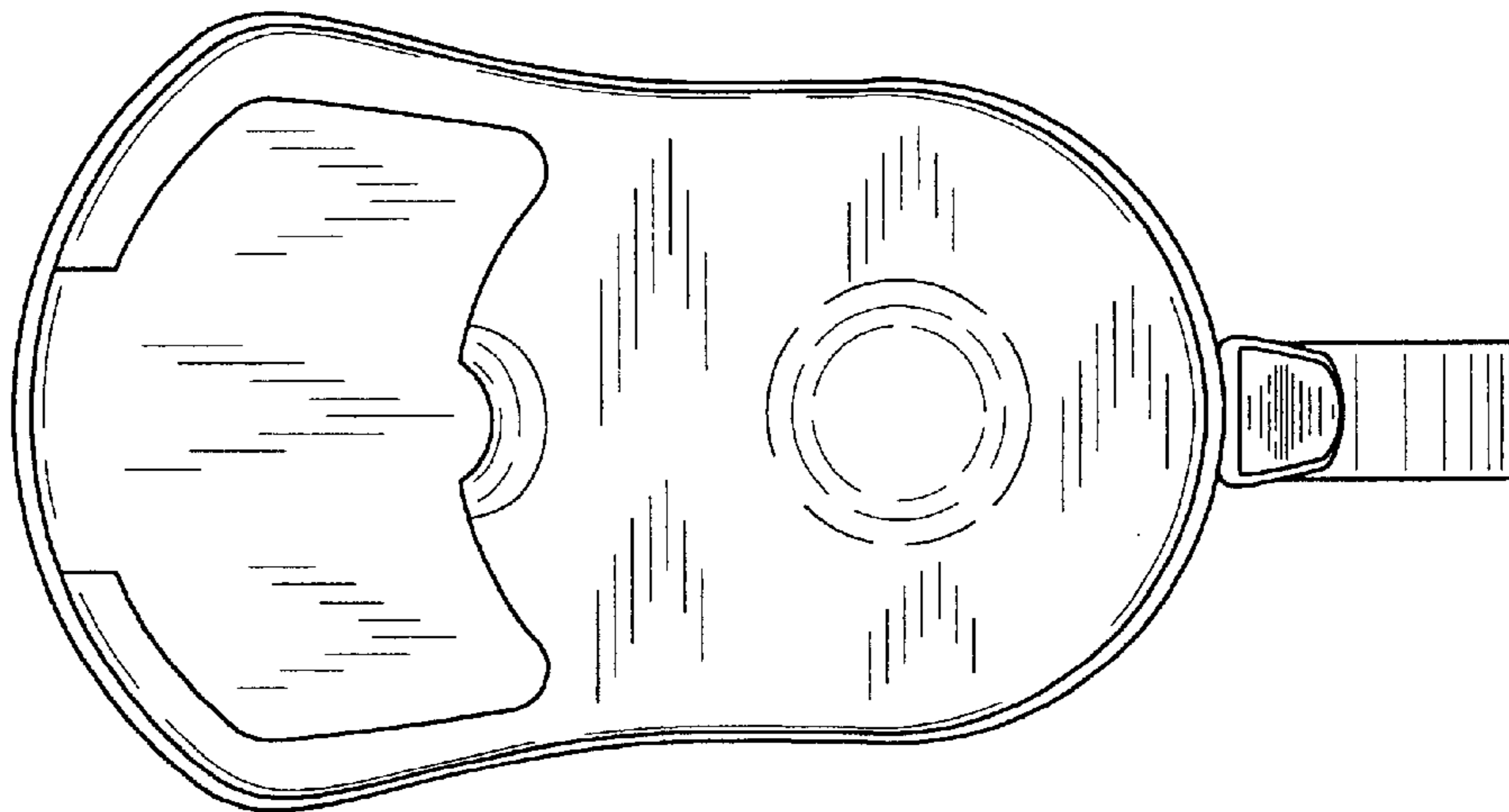

FIG. 5

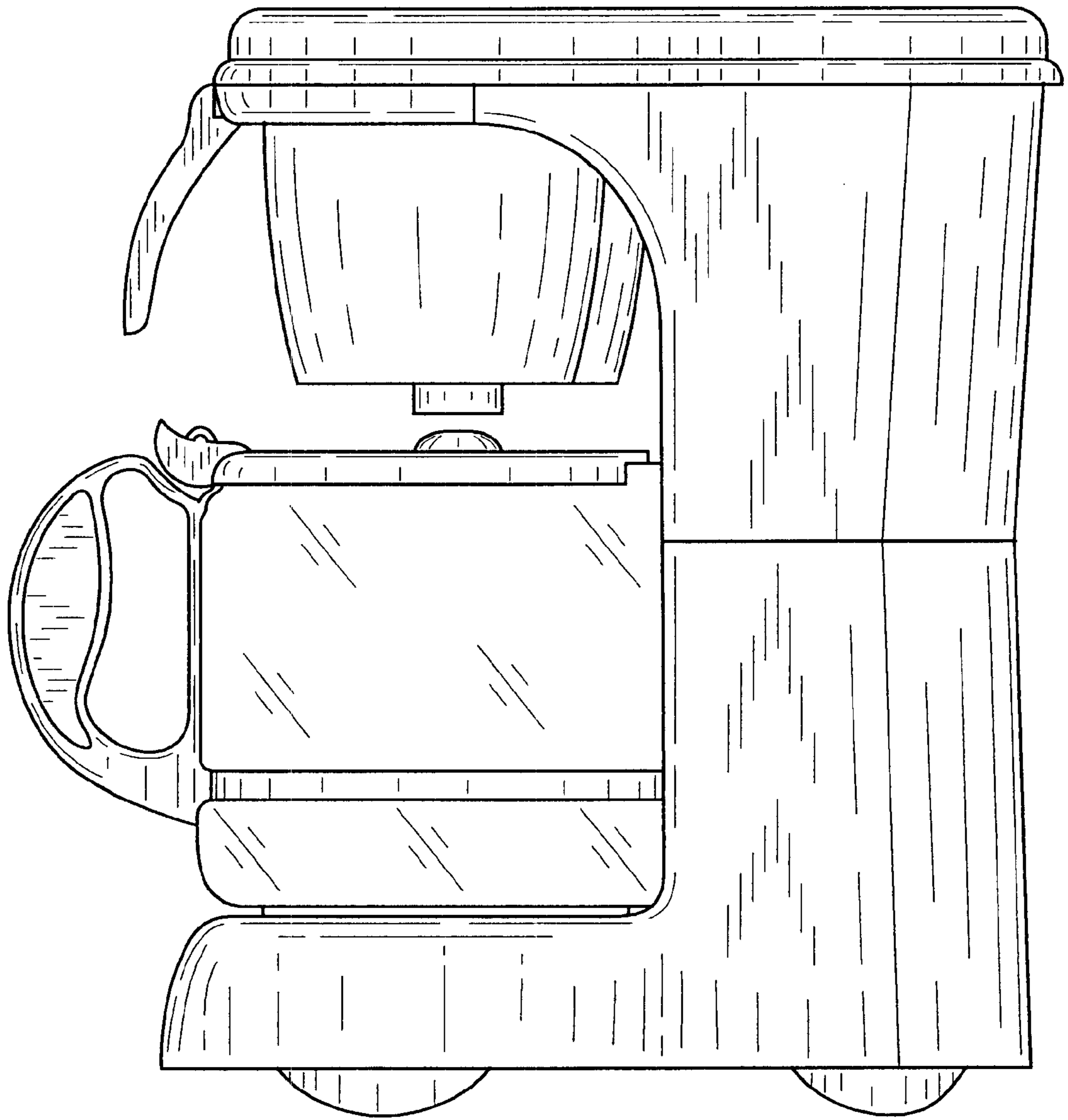

FIG. 6

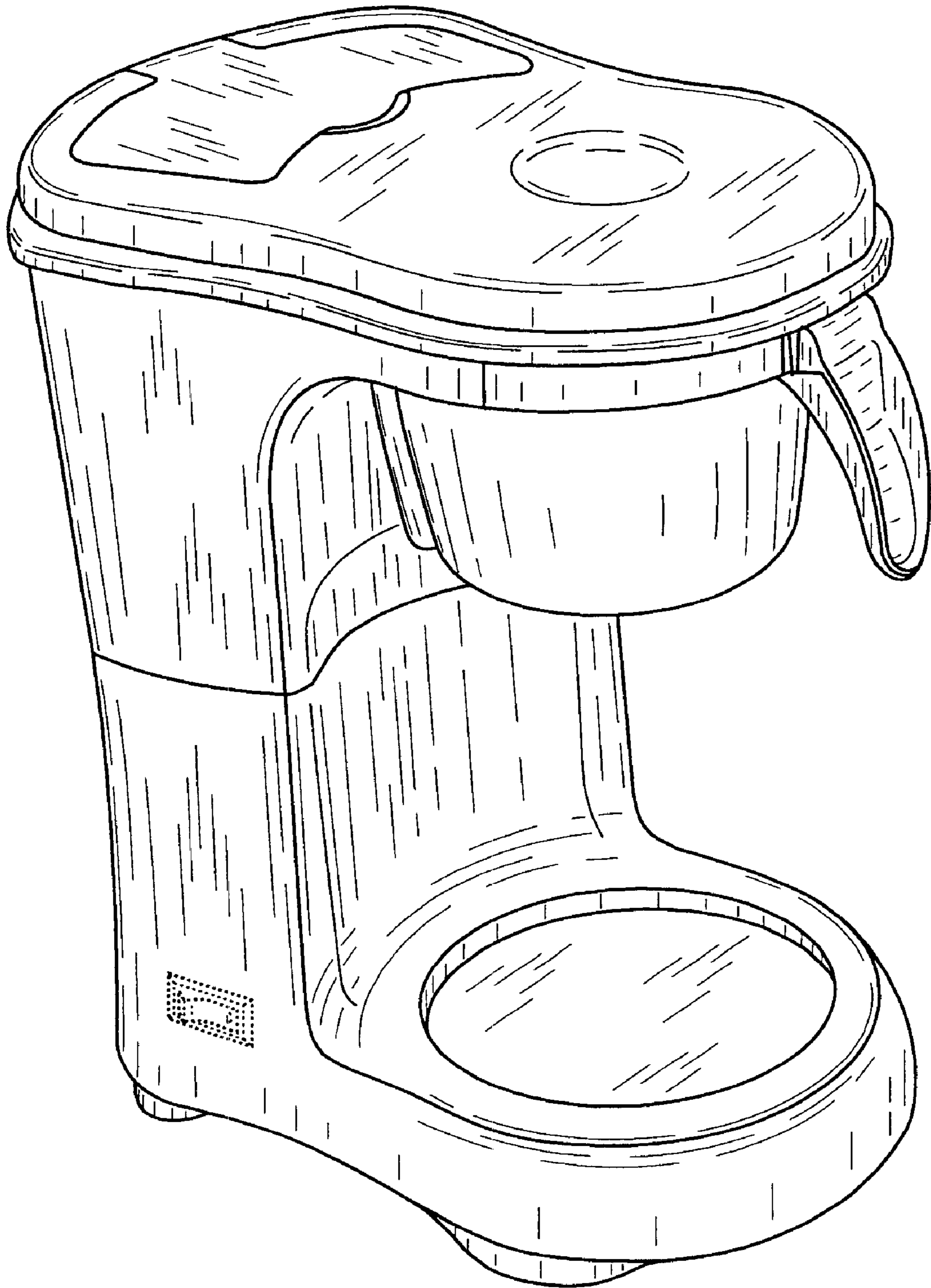

FIG. 7

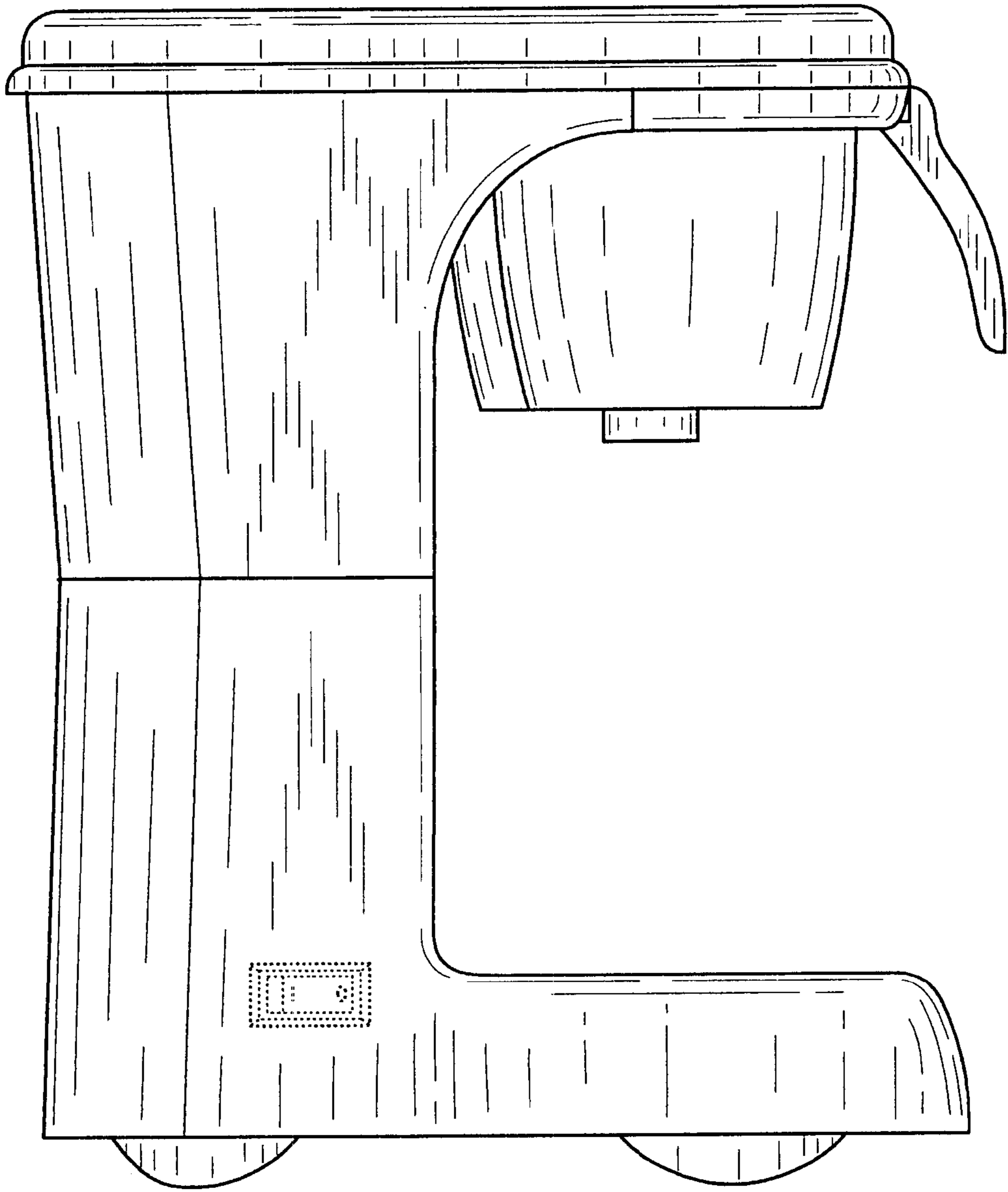

FIG. 8

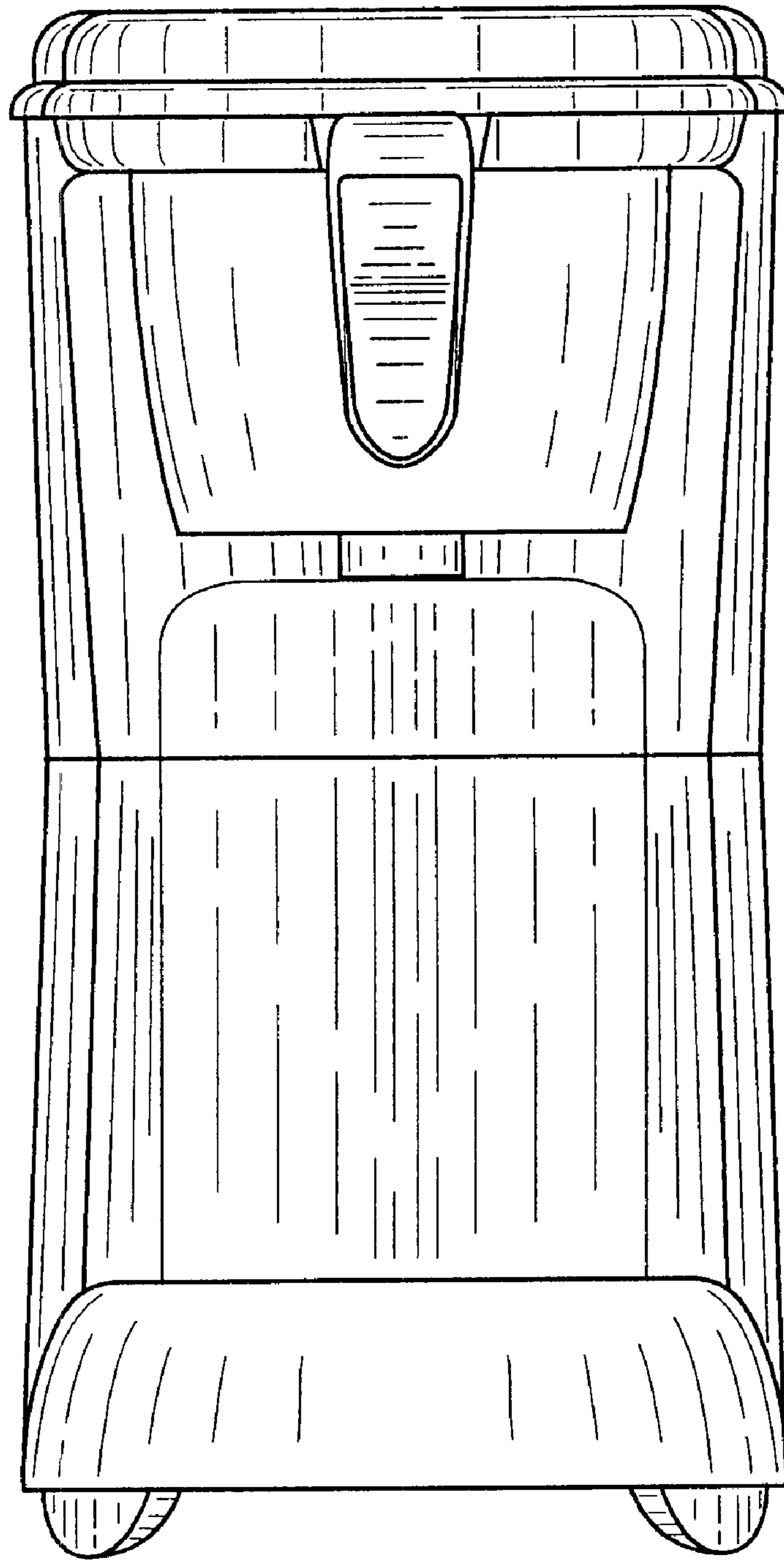

FIG. 9

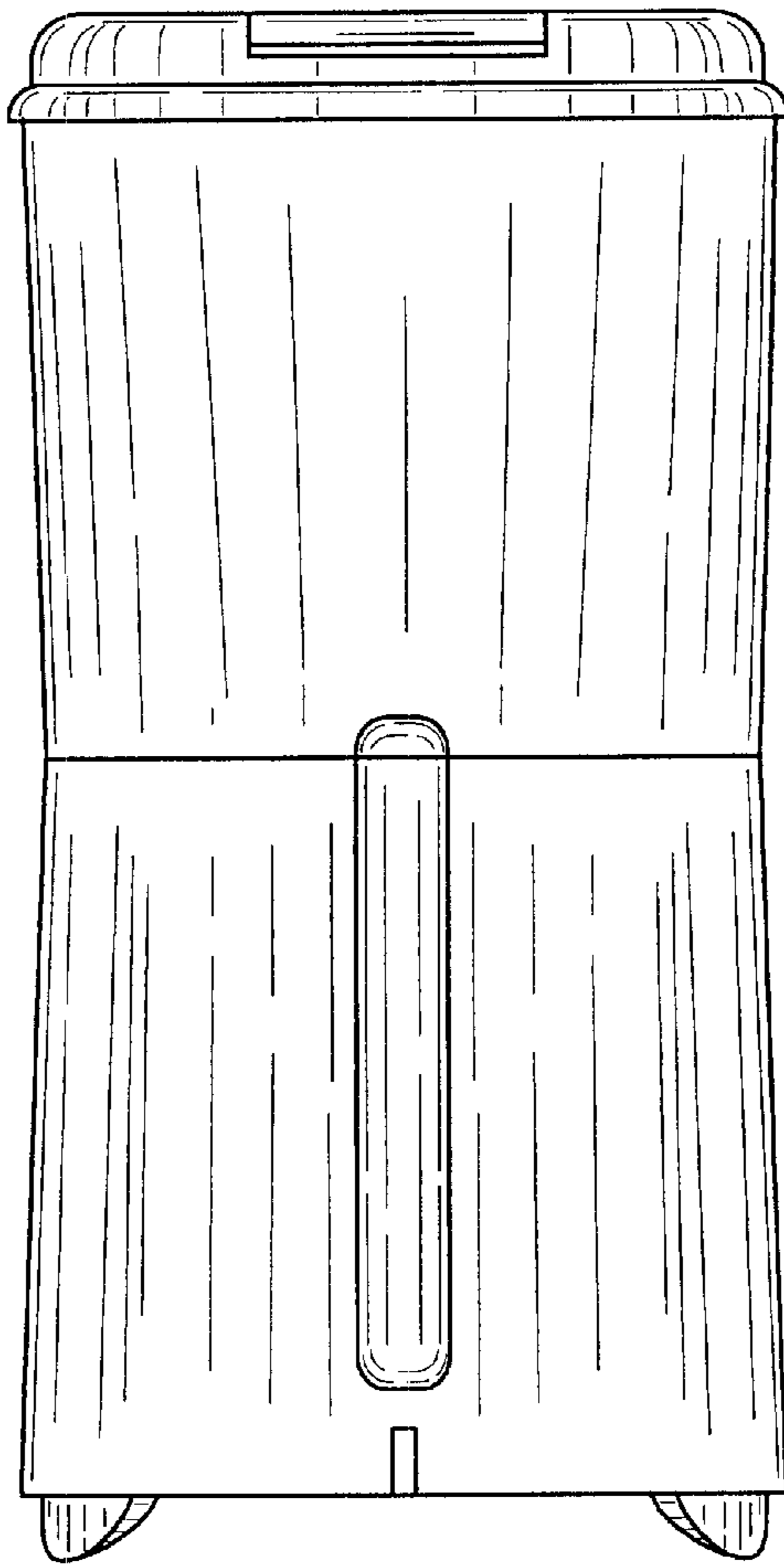

FIG. 10

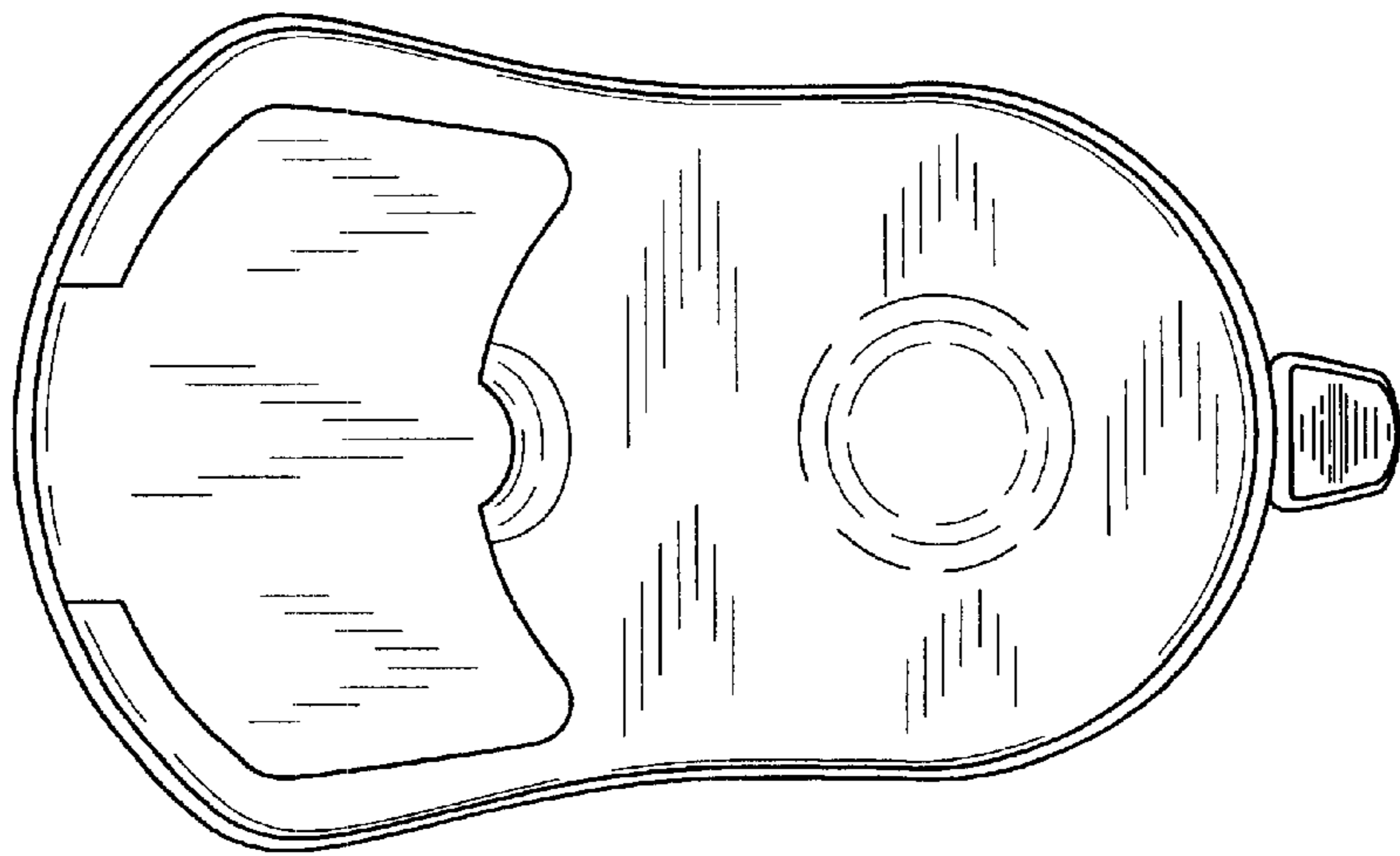

FIG. 11

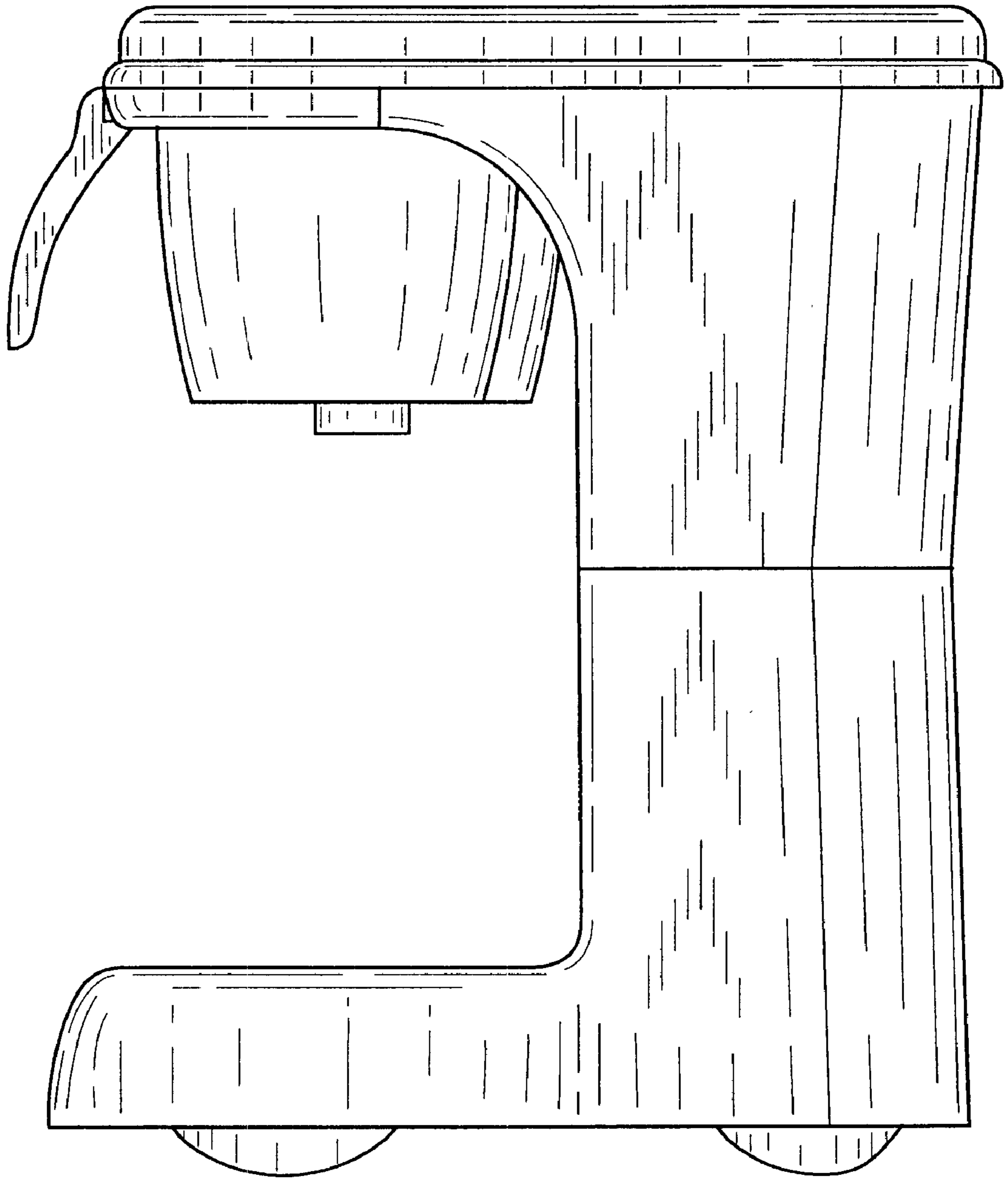

FIG. 12

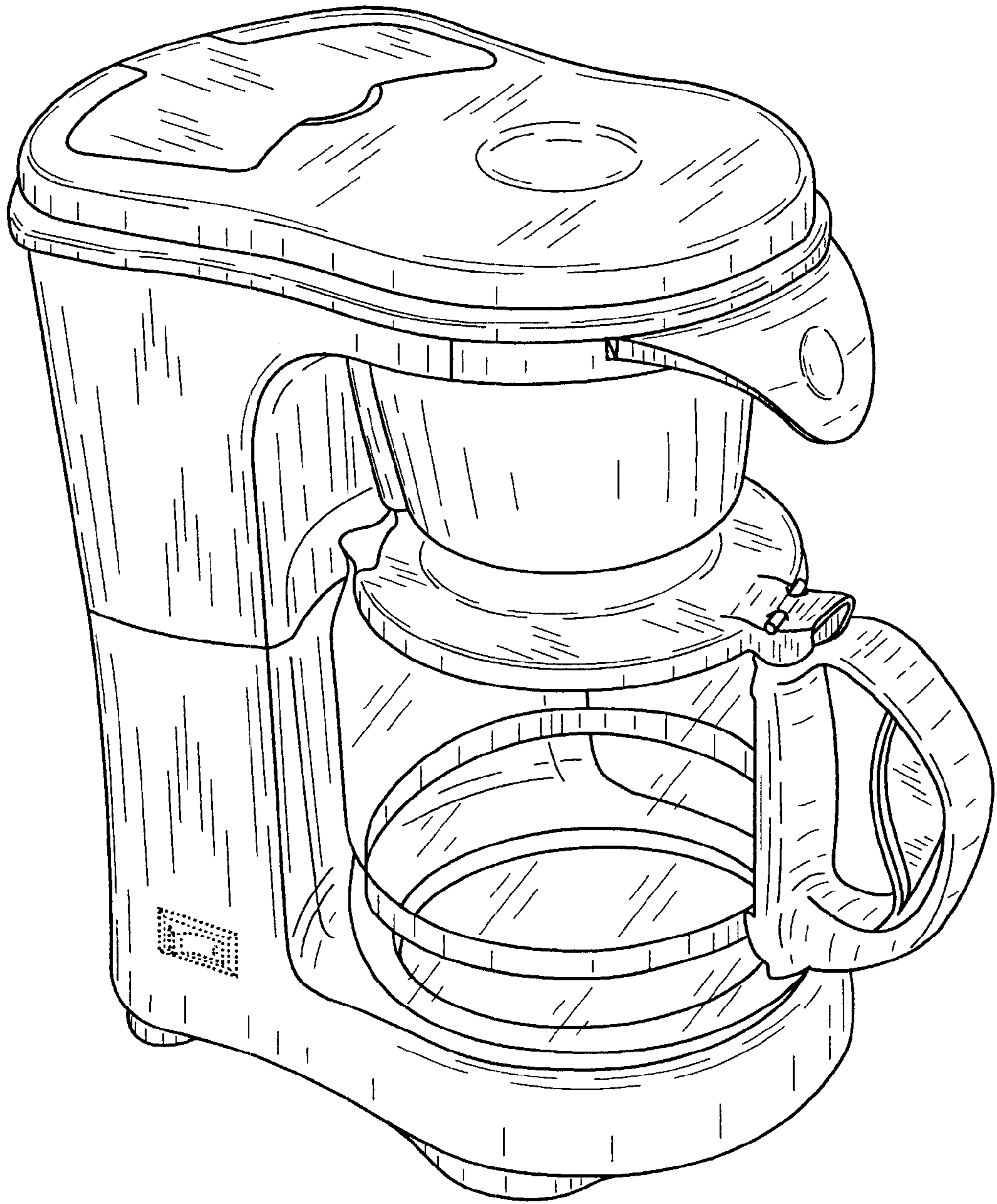

FIG. 13

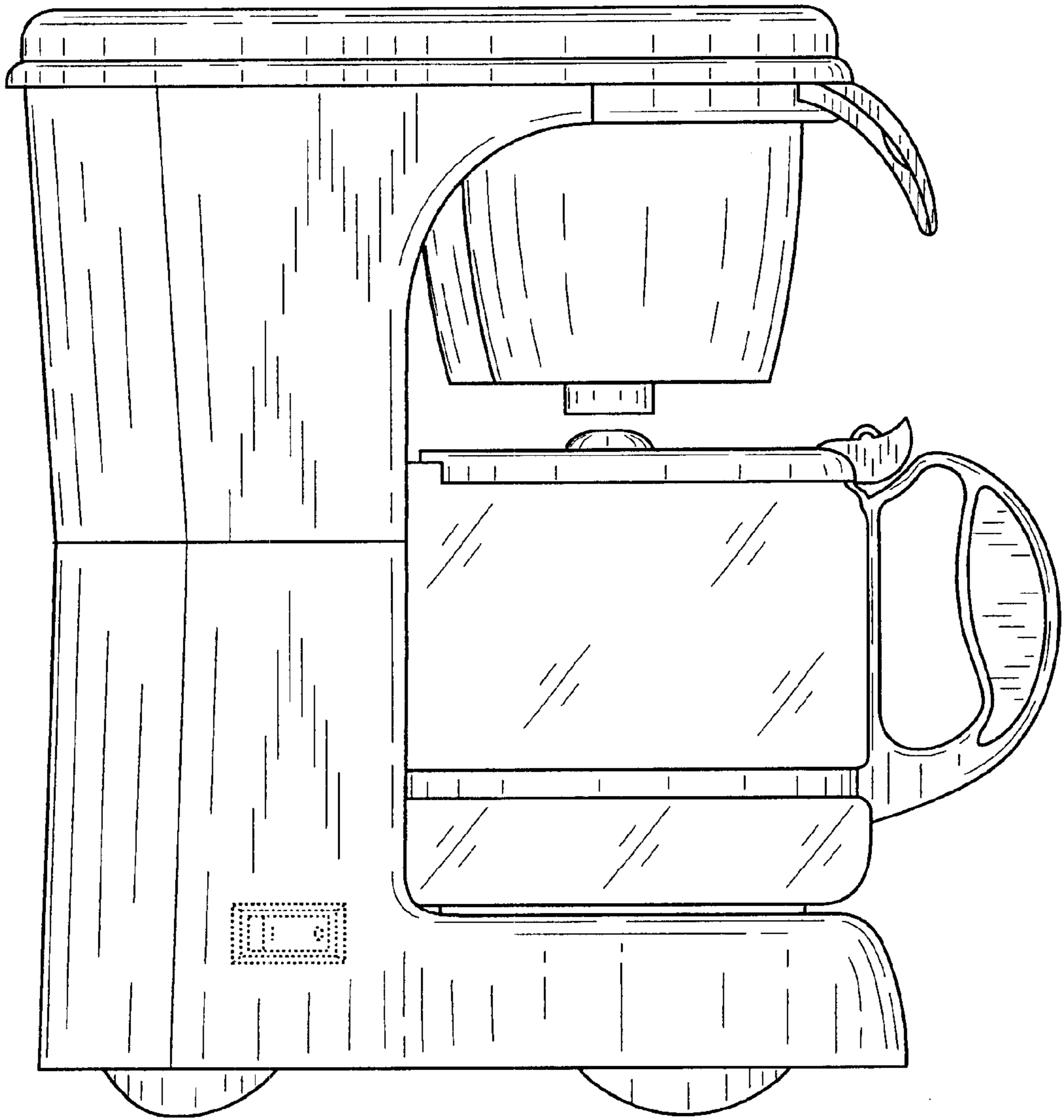

FIG. 14

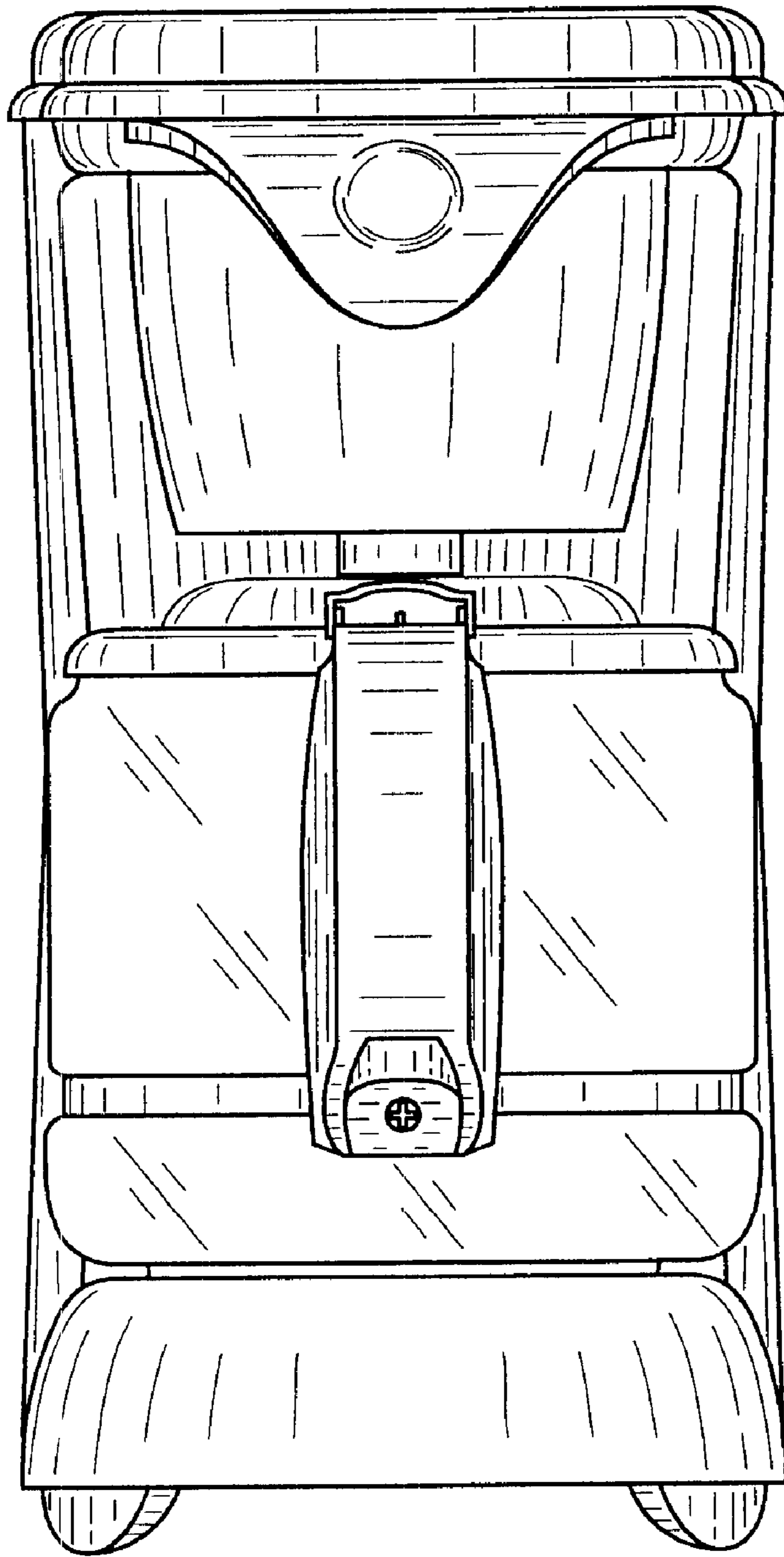

FIG. 15

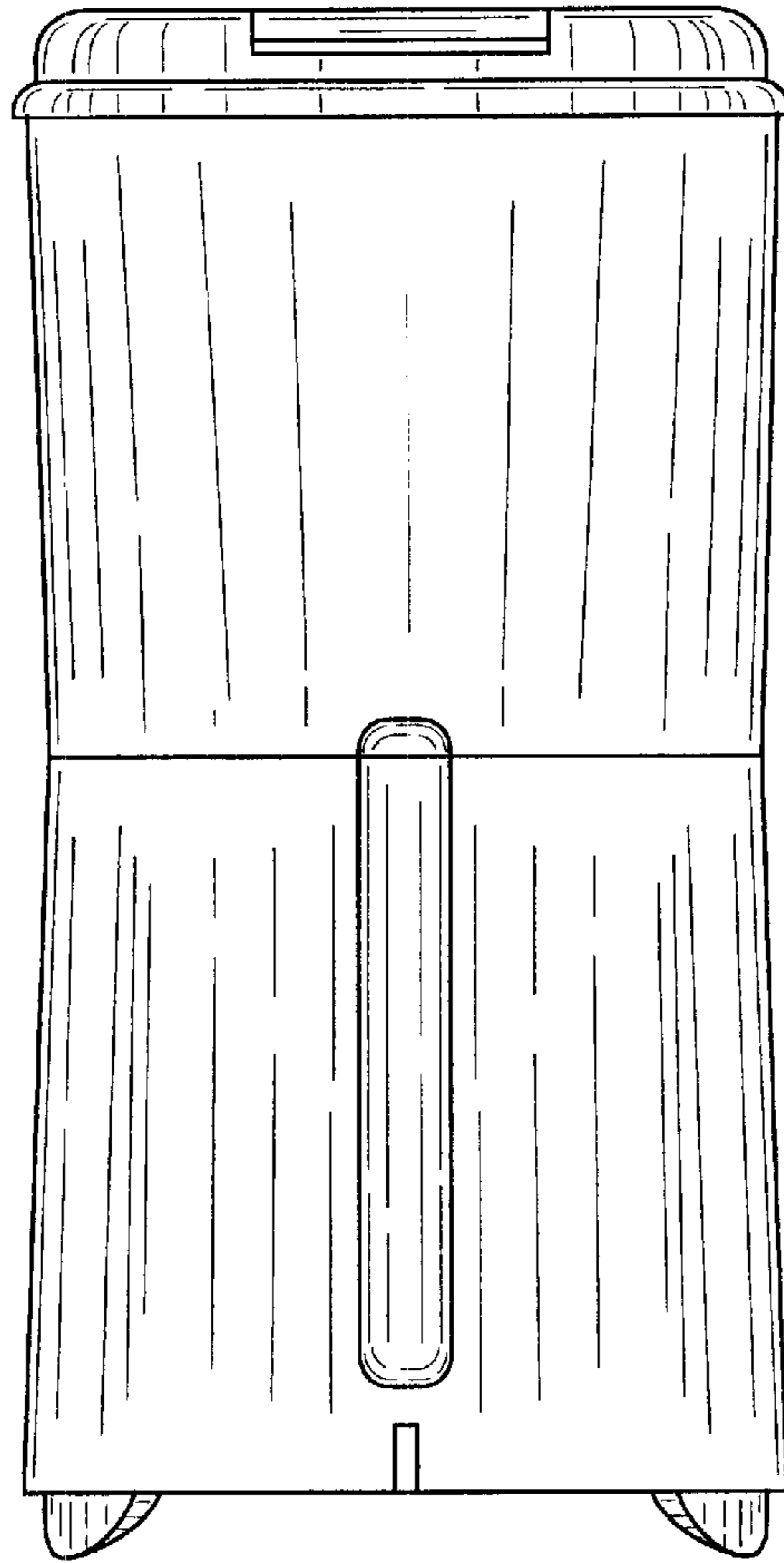

FIG. 16

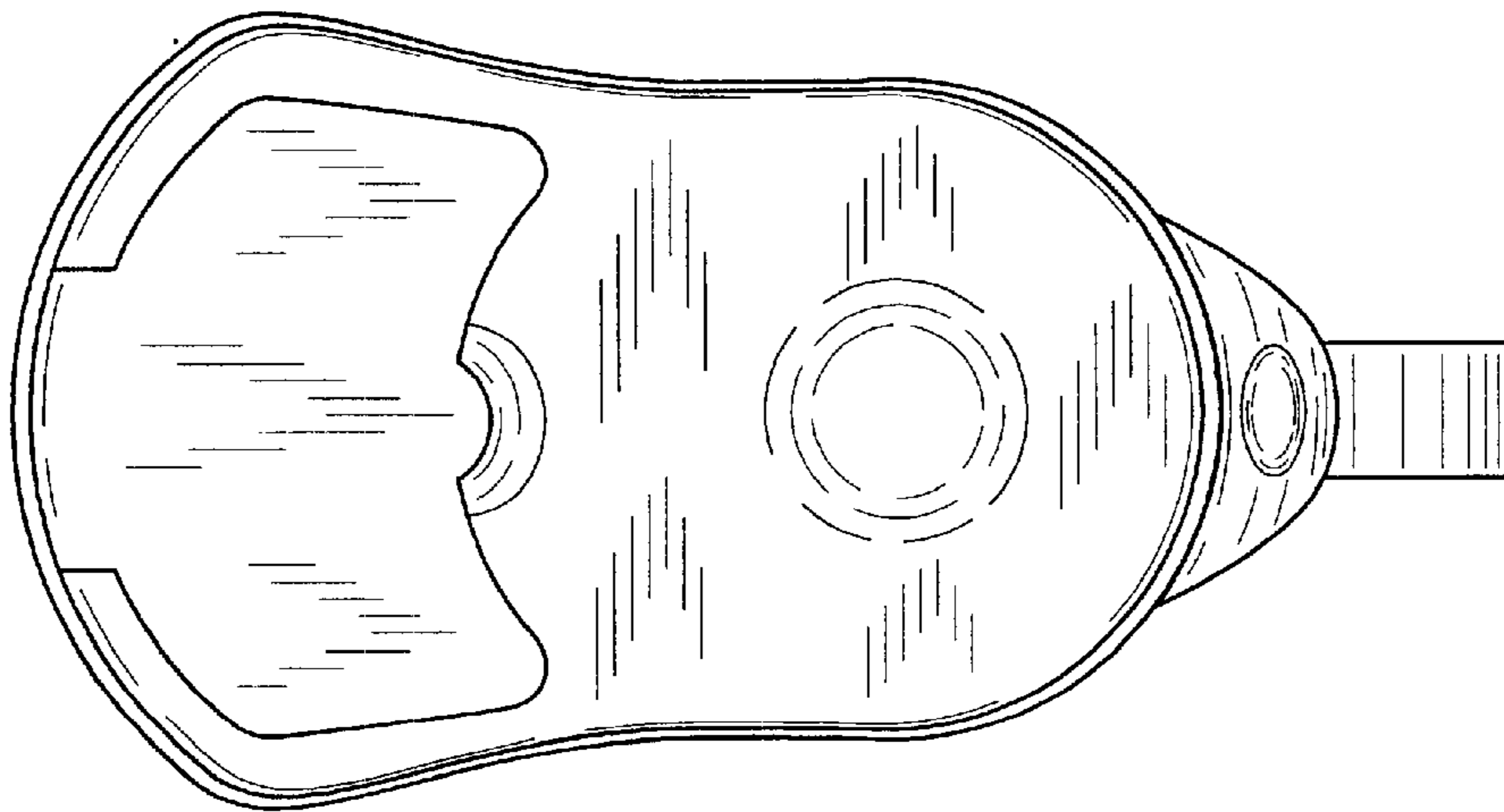

FIG. 17

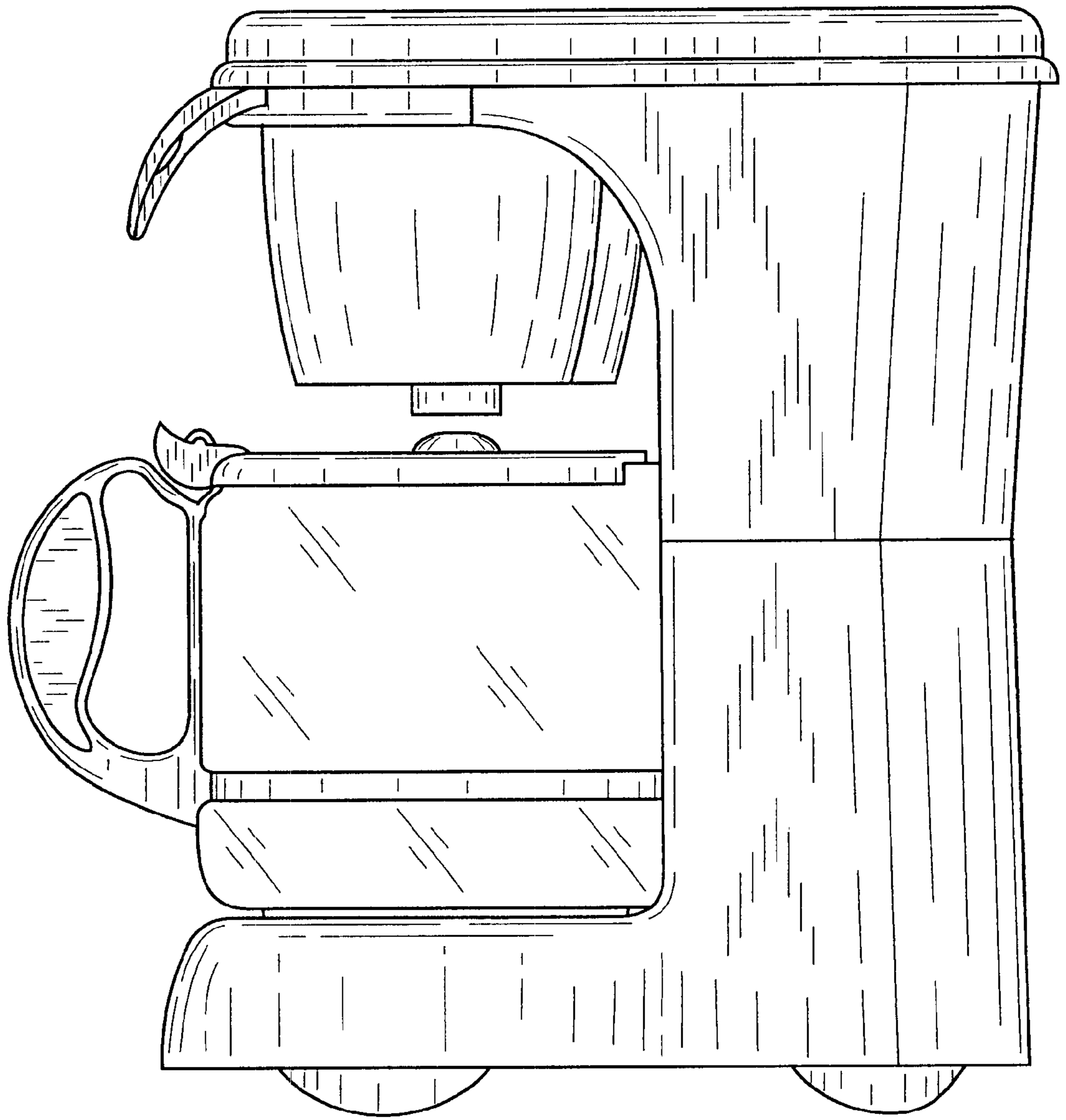

FIG. 18

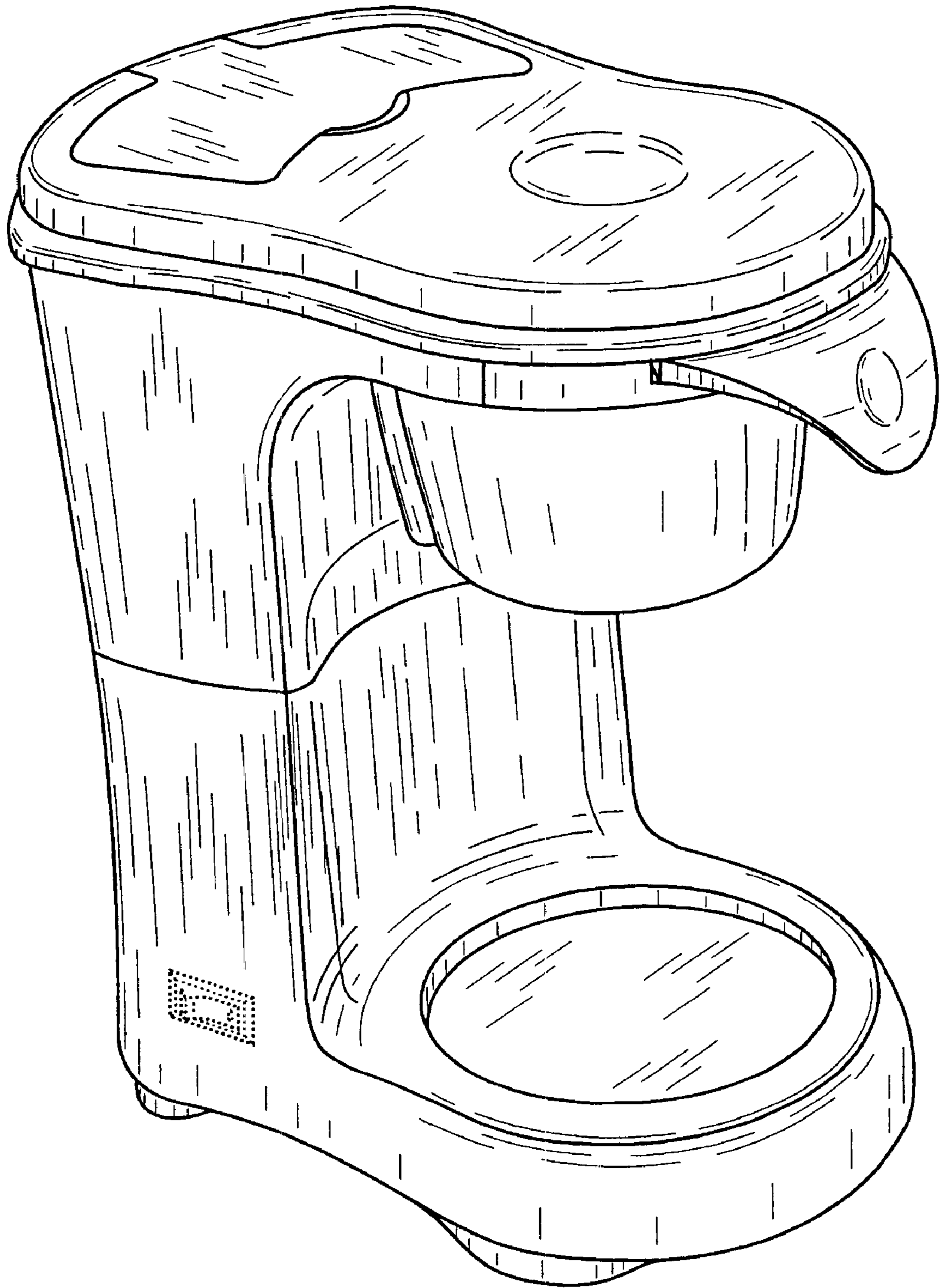

FIG. 19

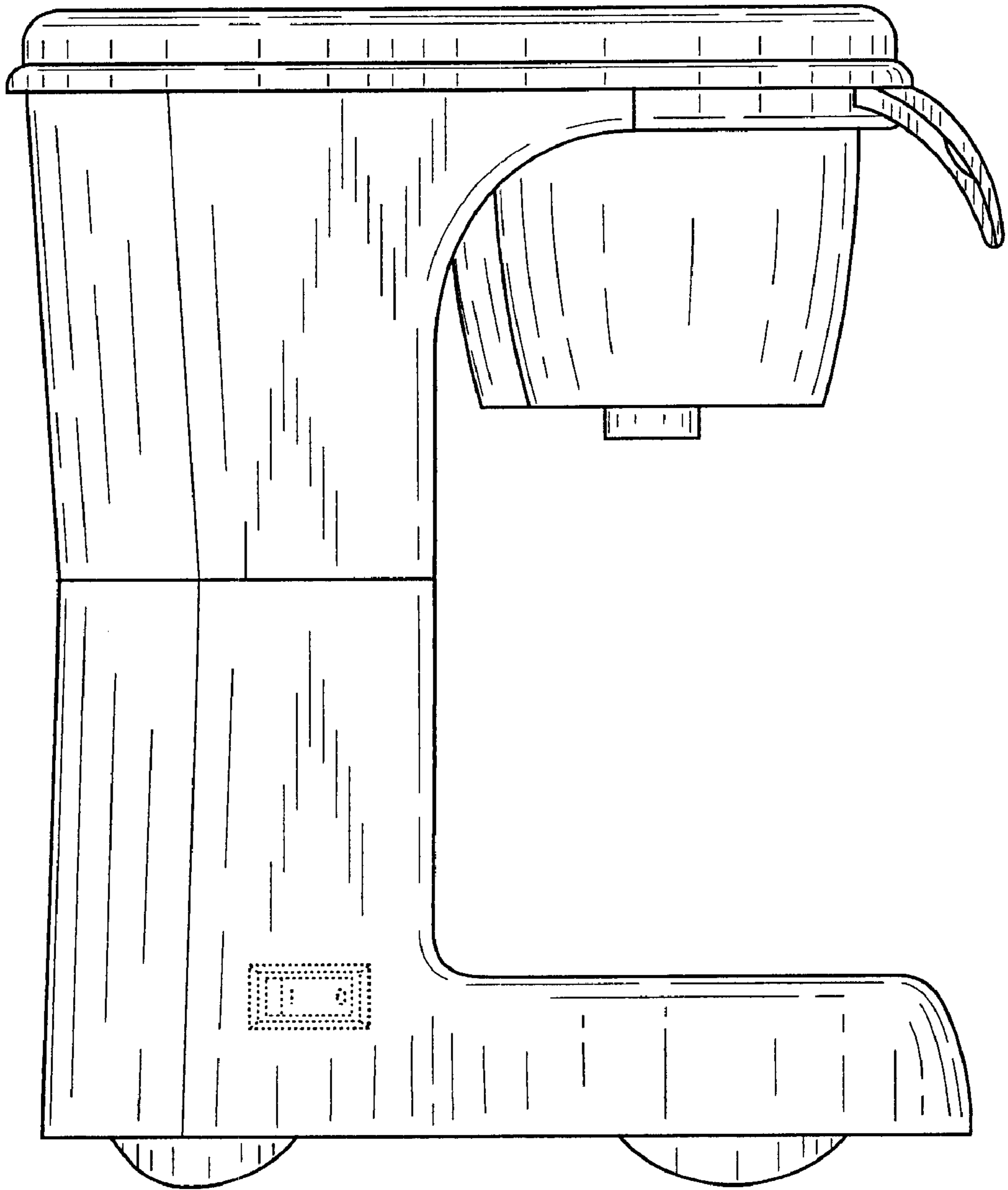

FIG. 20

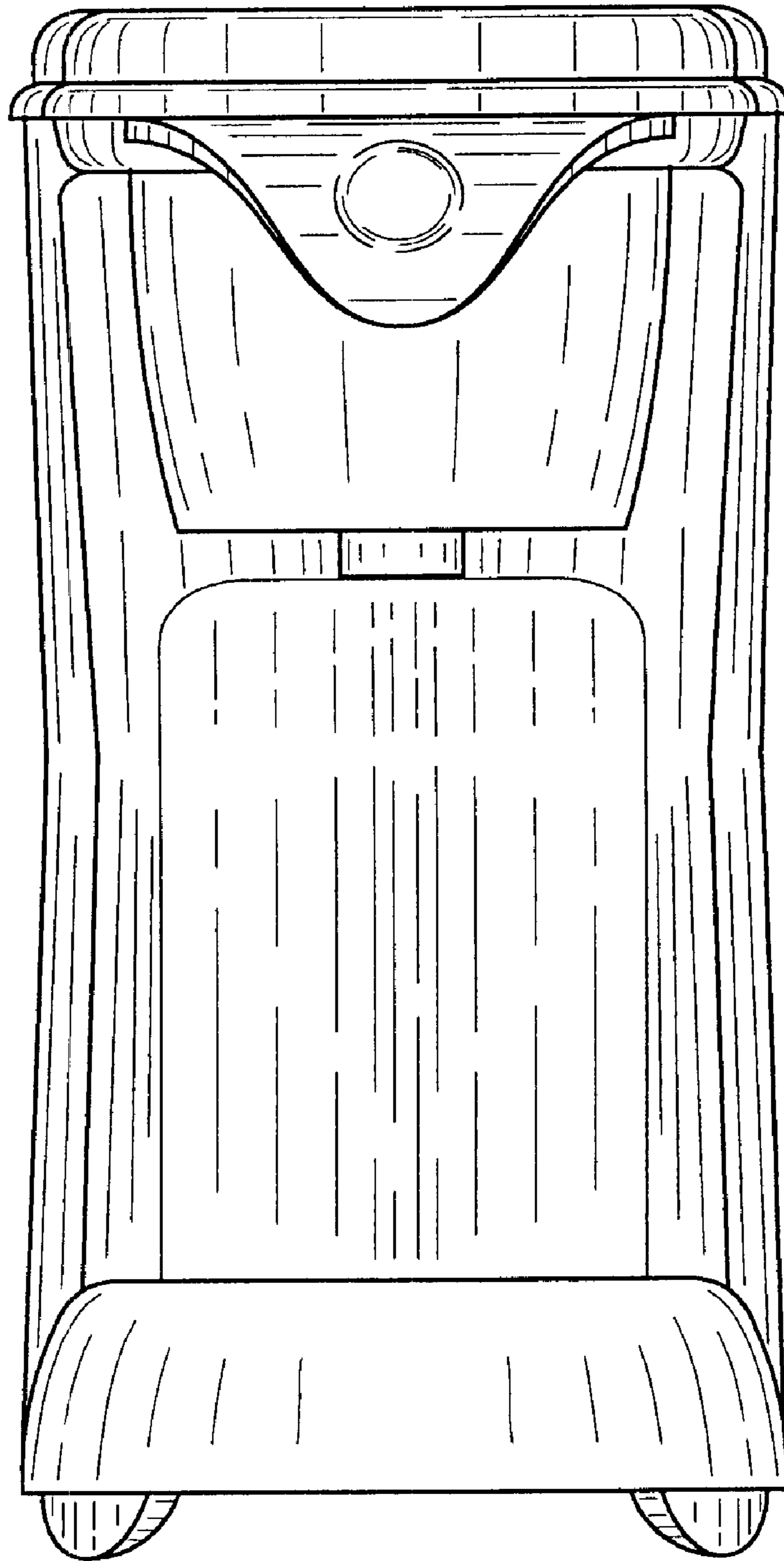

FIG. 21

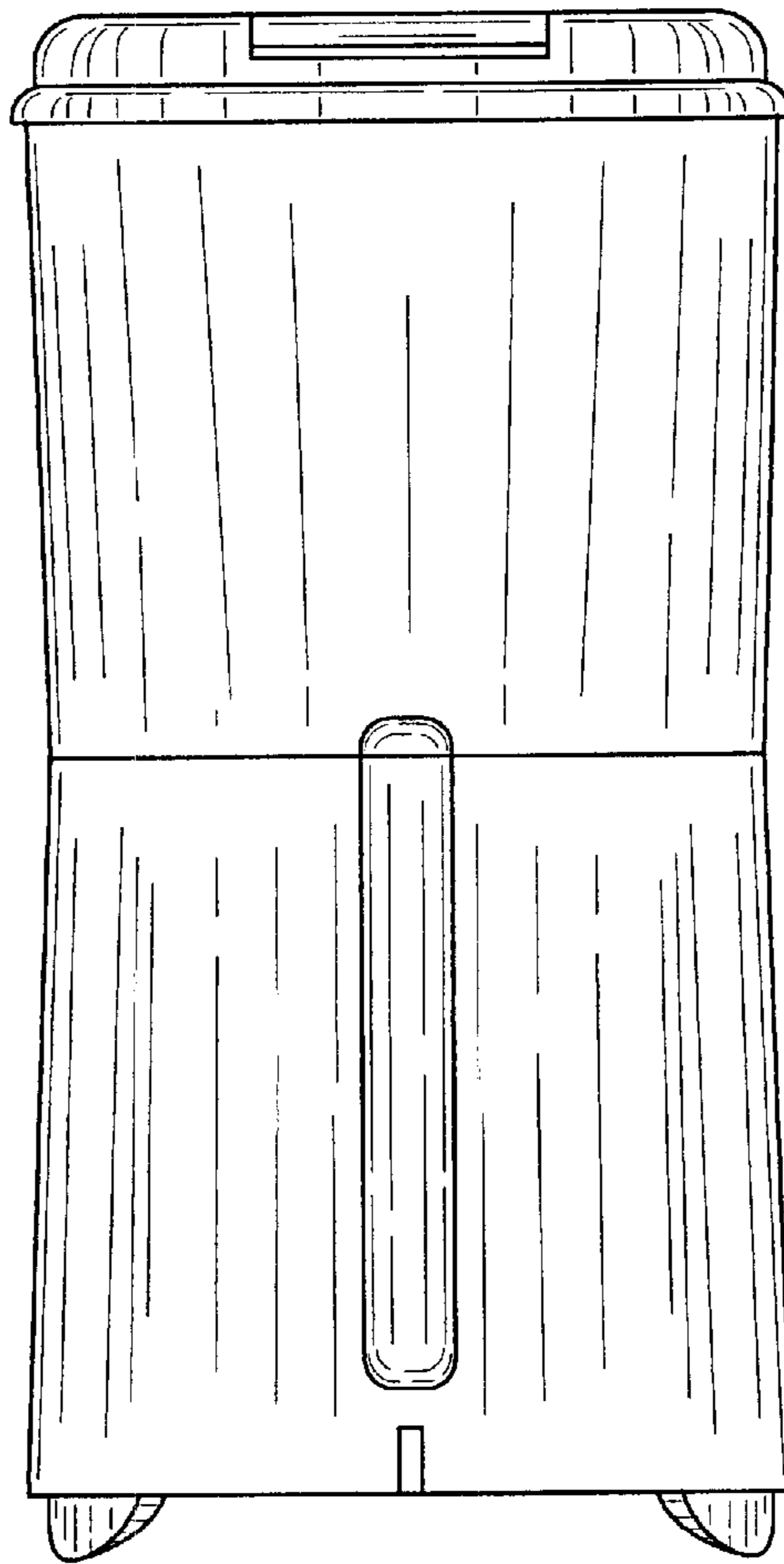

FIG. 22

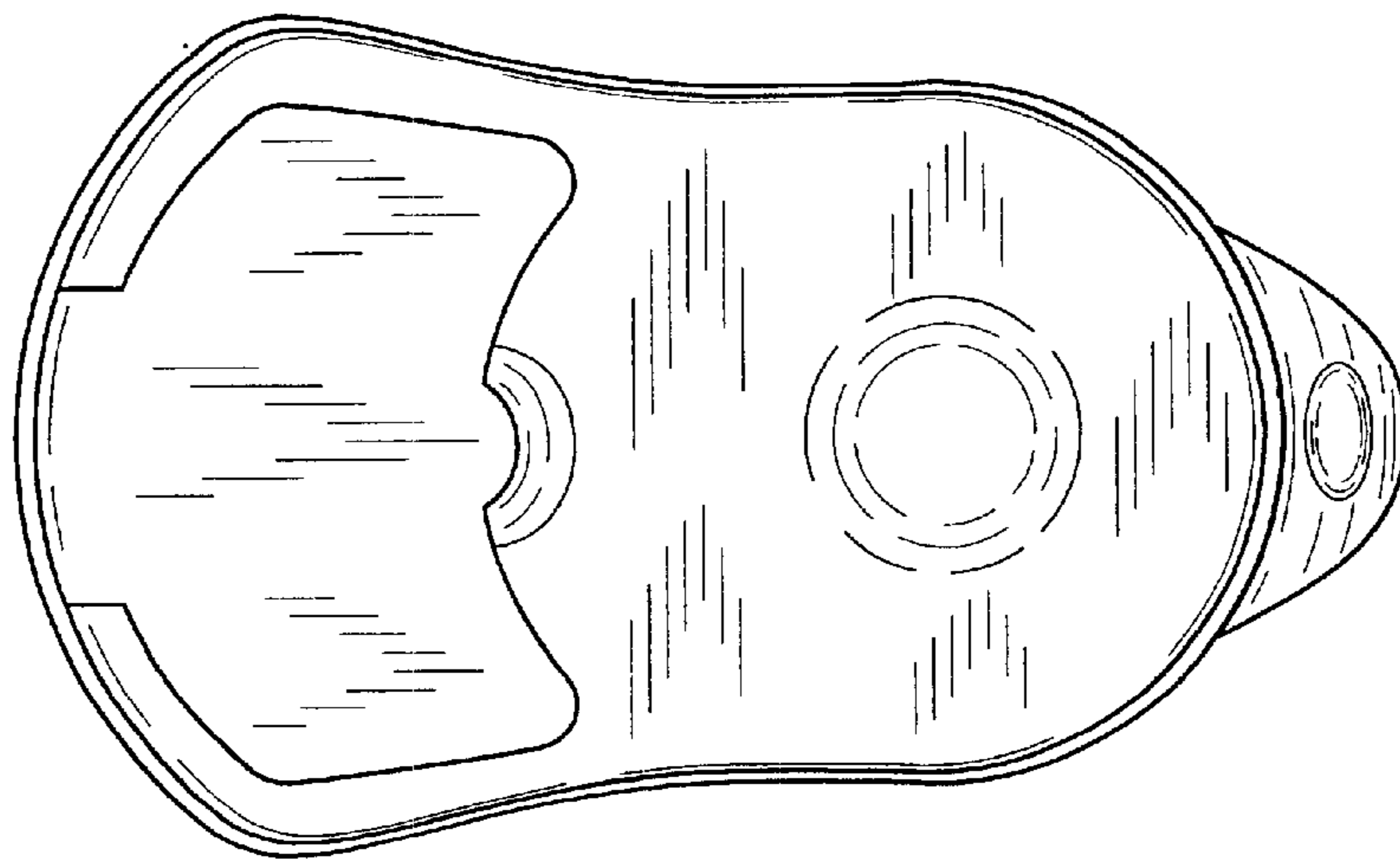

FIG. 23

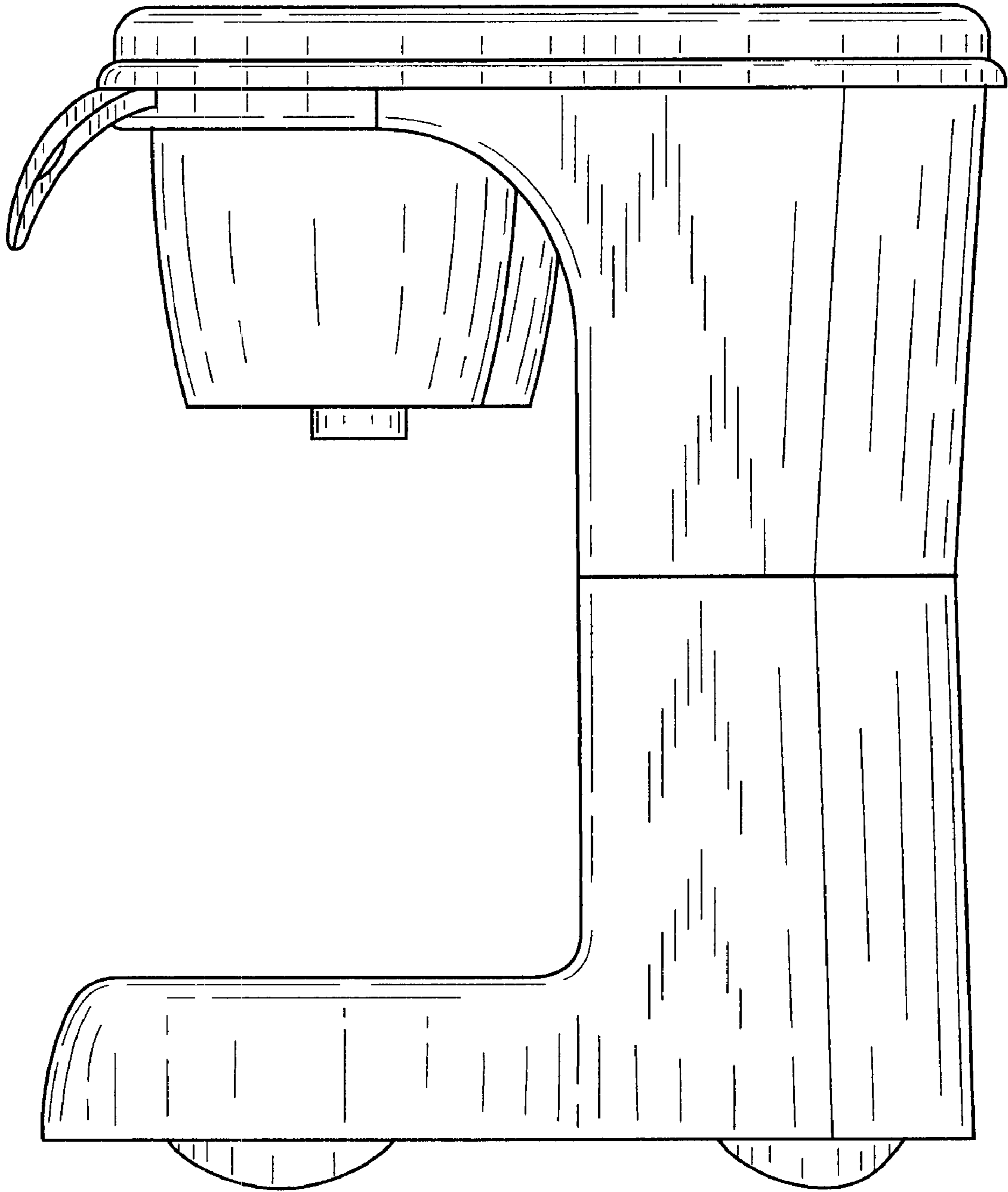

FIG. 24