



US00D462169S

(12) **United States Design Patent**
Giovanni

(10) **Patent No.:** **US D462,169 S**

(45) **Date of Patent:** **** Sep. 3, 2002**

(54) **LUGGAGE**

(75) Inventor: **Roncato Giovanni**, Campodarsego (IT)

(73) Assignee: **Valigeria Roncato SPA**, Campodarsego (IT)

(**) Term: **14 Years**

(21) Appl. No.: **29/146,928**

(22) Filed: **Aug. 24, 2001**

(30) **Foreign Application Priority Data**

Mar. 23, 2001 (IT) TV0100017

(51) **LOC (7) Cl.** **03-10**

(52) **U.S. Cl.** **D3/279**

(58) **Field of Search** D3/273, 276, 279,
D3/281, 282, 294; 190/18 A, 100, 109,
111, 112, 113, 114

(56) **References Cited**

U.S. PATENT DOCUMENTS

- D383,603 S * 9/1997 Pedlar D3/279
- D414,933 S * 10/1999 Yu D3/274
- D422,409 S * 4/2000 Klenner et al. D3/276
- D425,301 S * 5/2000 Sagol D3/279

- D427,434 S * 7/2000 King et al. D3/276
- D428,698 S * 8/2000 Cheng D3/276
- D434,224 S * 11/2000 Tiramani et al. D3/276
- D438,005 S * 2/2001 Tiramani et al. D3/273
- D444,946 S * 7/2001 Klamm D3/279

* cited by examiner

Primary Examiner—Philip S. Hyder

(74) *Attorney, Agent, or Firm*—Harrison & Egbert

(57) **CLAIM**

I claim the ornamental design for a luggage, as shown and described.

DESCRIPTION

FIG. 1 is an upper perspective view of the luggage showing my design.

FIG. 2 is a top view thereof;

FIG. 3 is a bottom view thereof;

FIG. 4 is a side view thereof;

FIG. 5 is an opposite side view thereof;

FIG. 6 is a front view thereof;

FIG. 7 is a back view thereof; and,

FIG. 8 is a side view thereof, showing extension of the handle.

1 Claim, 8 Drawing Sheets

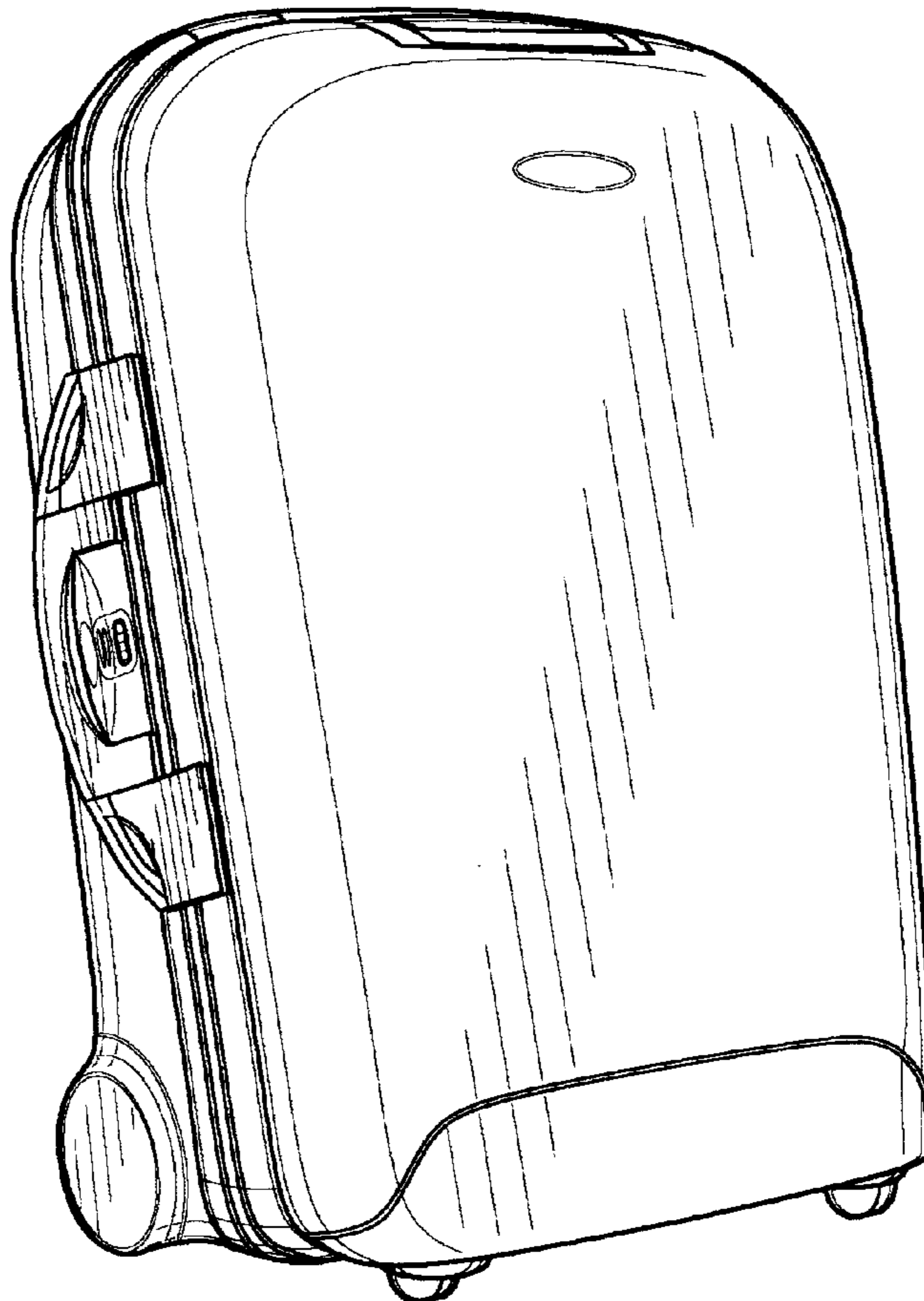

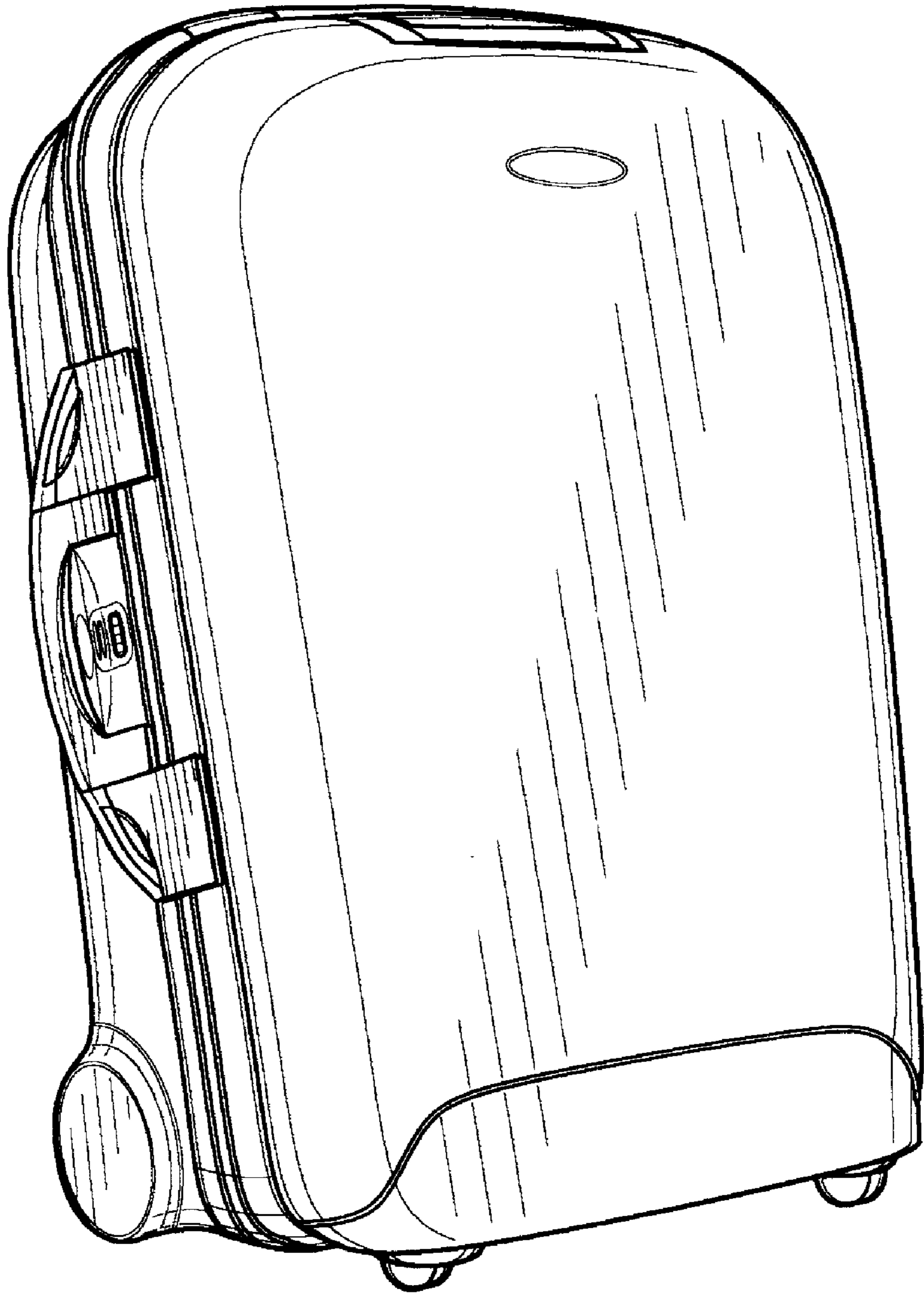

FIG. 1

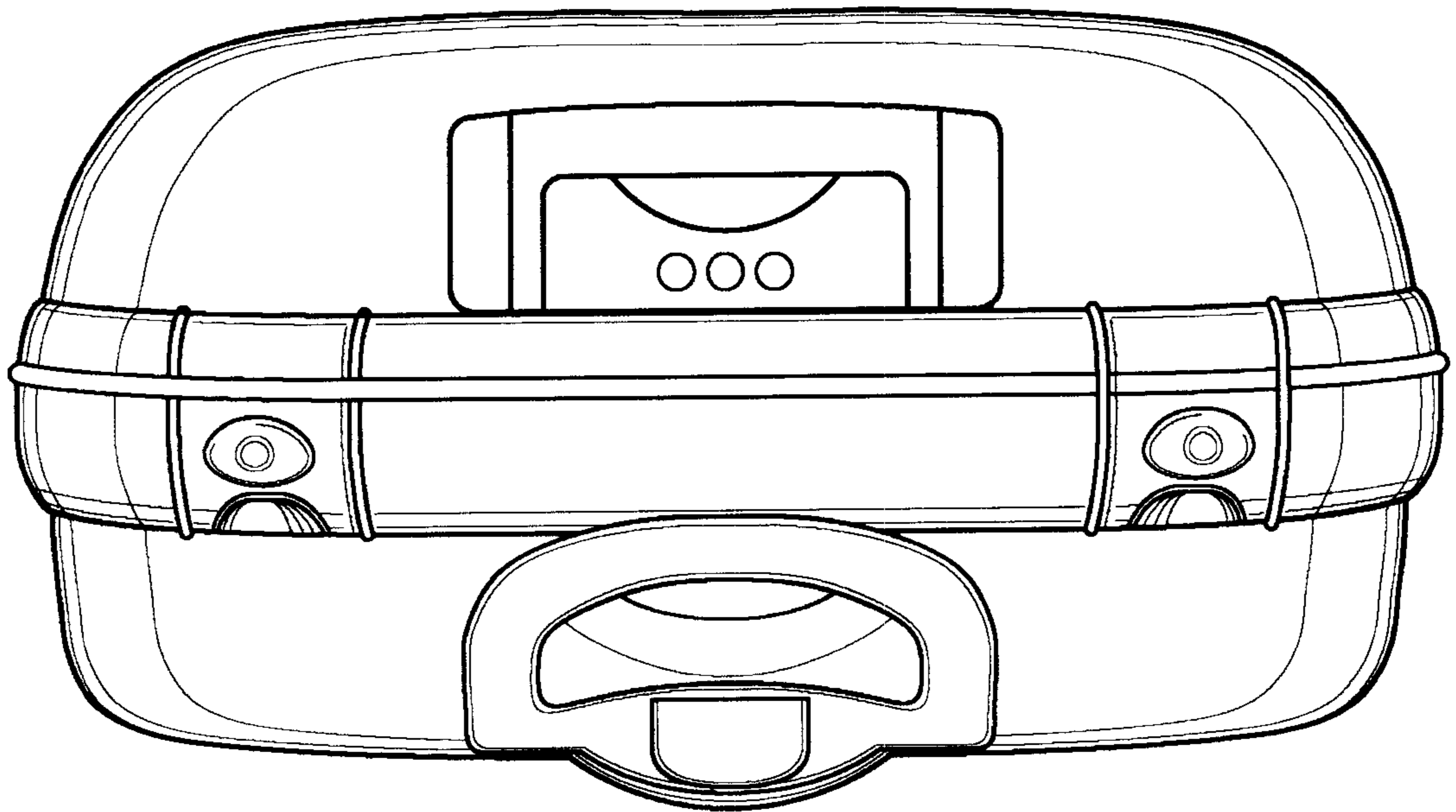

FIG. 2

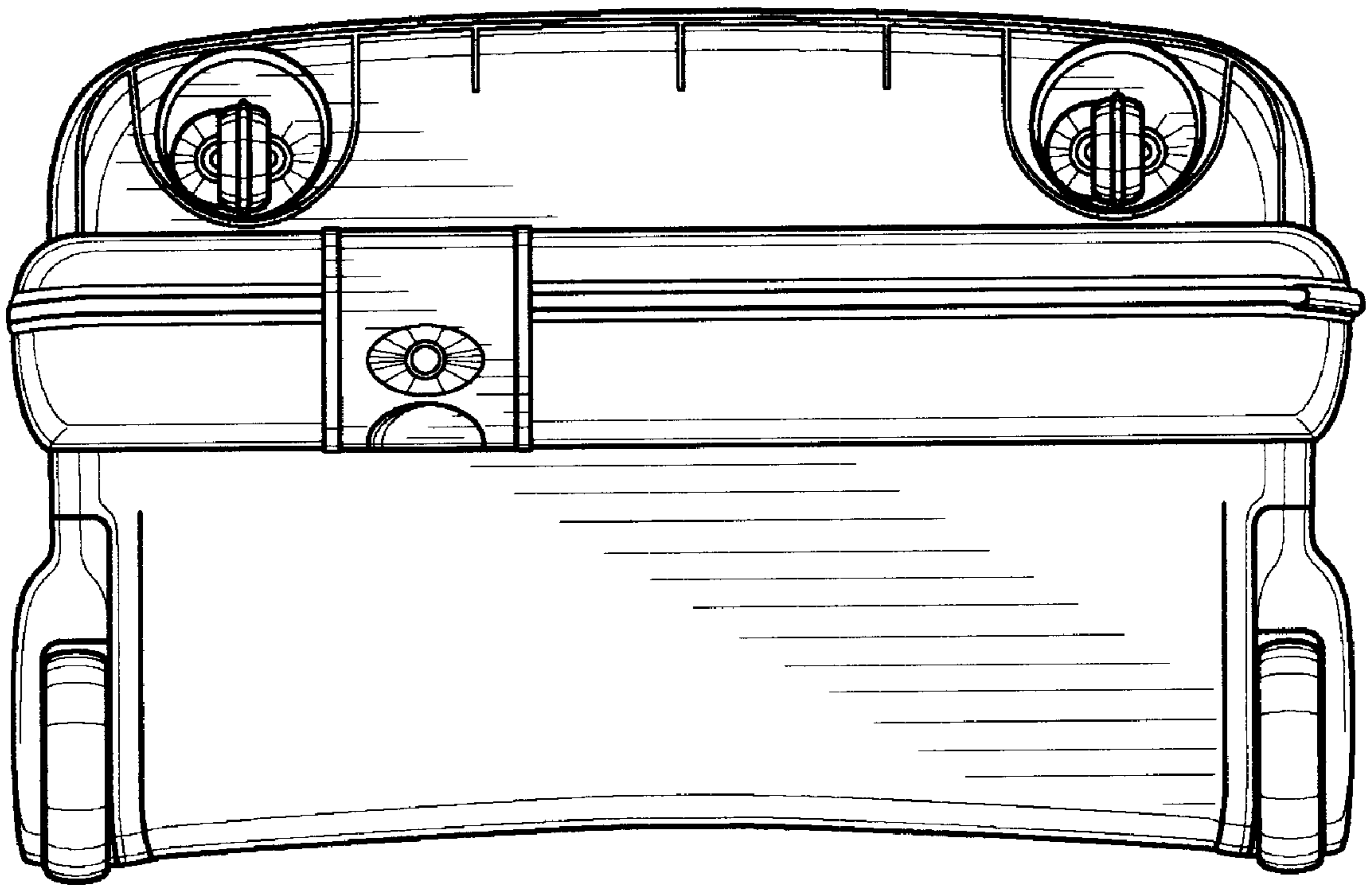

FIG. 3

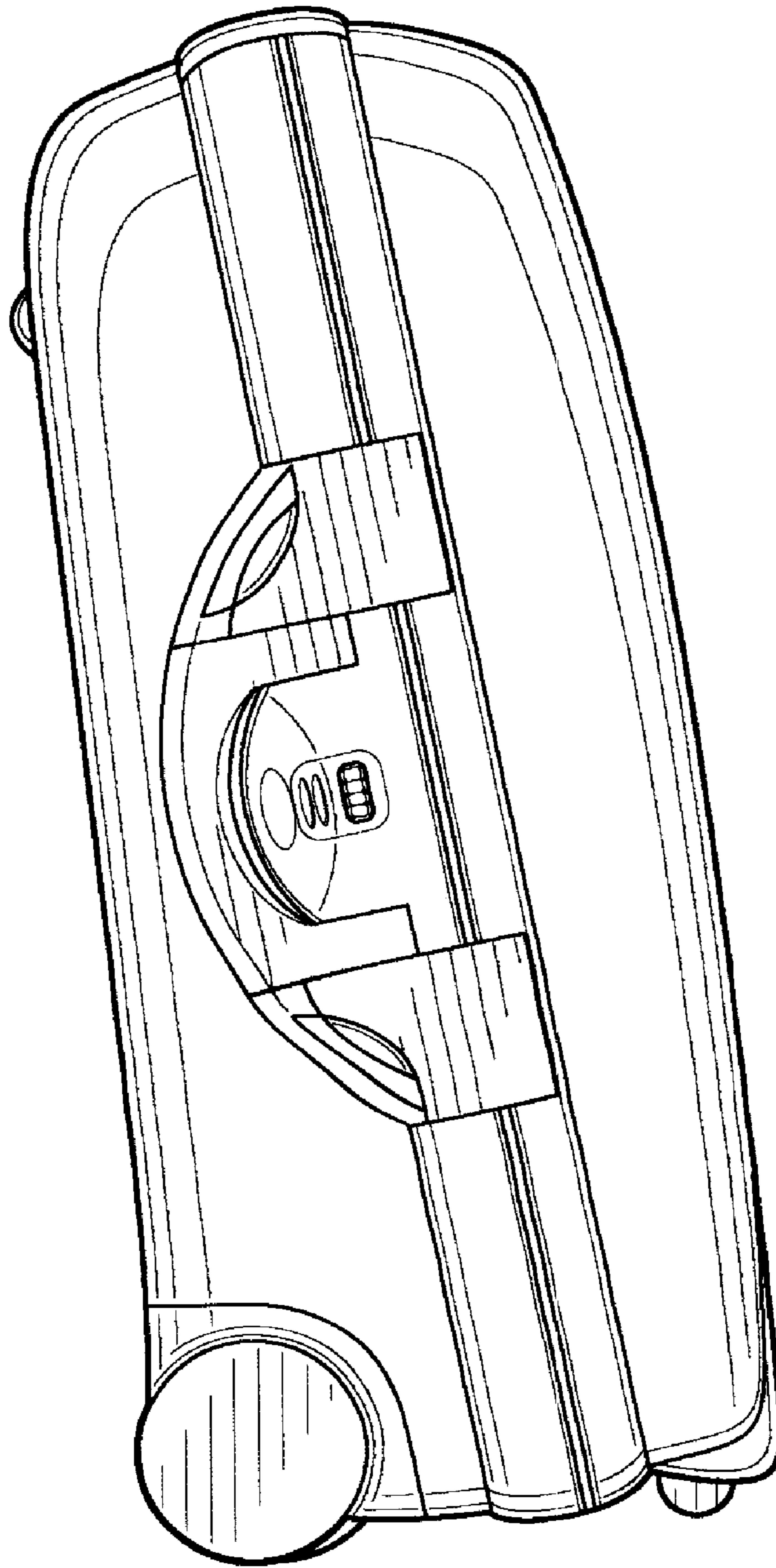

FIG. 4

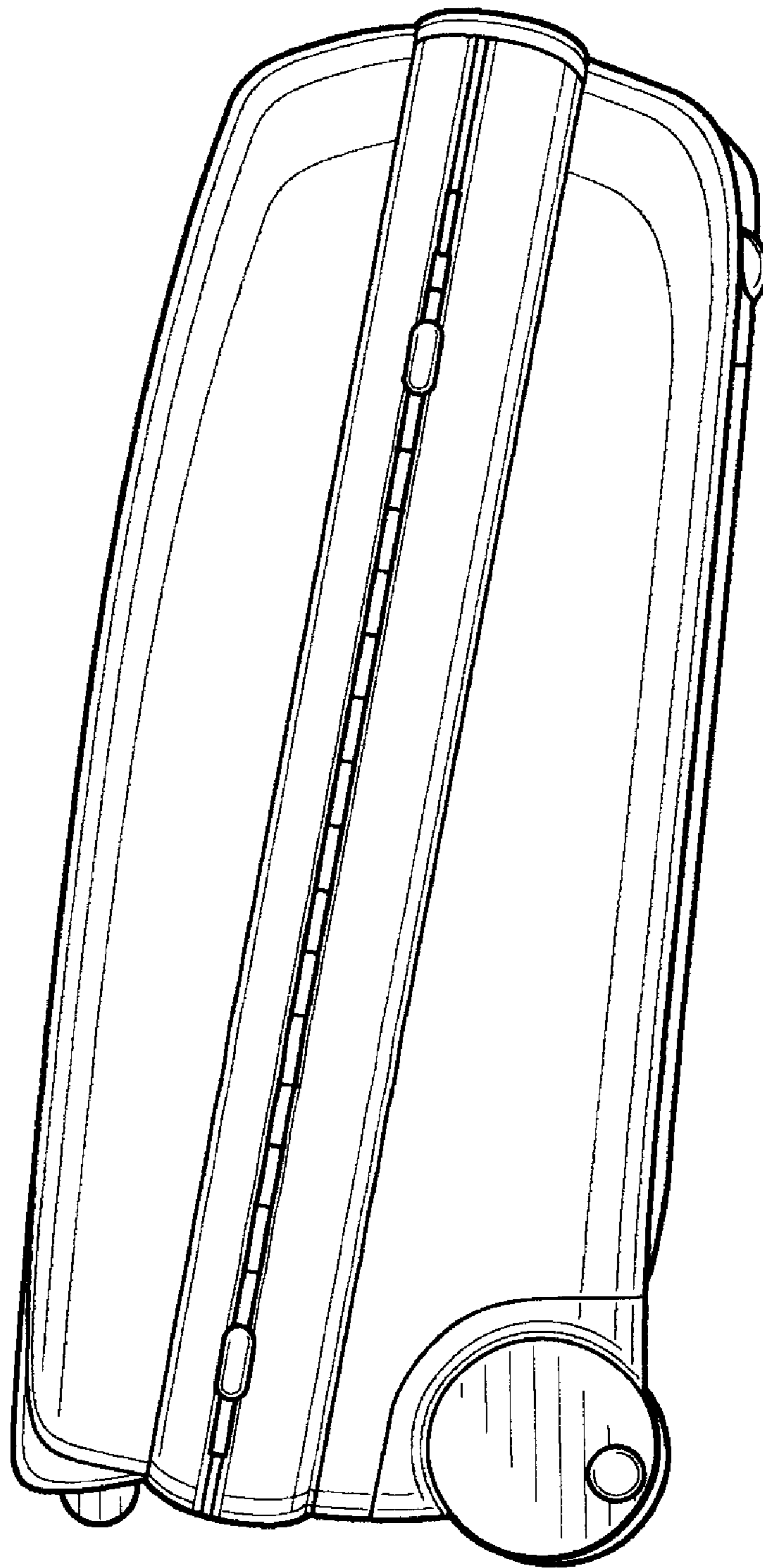

FIG. 5

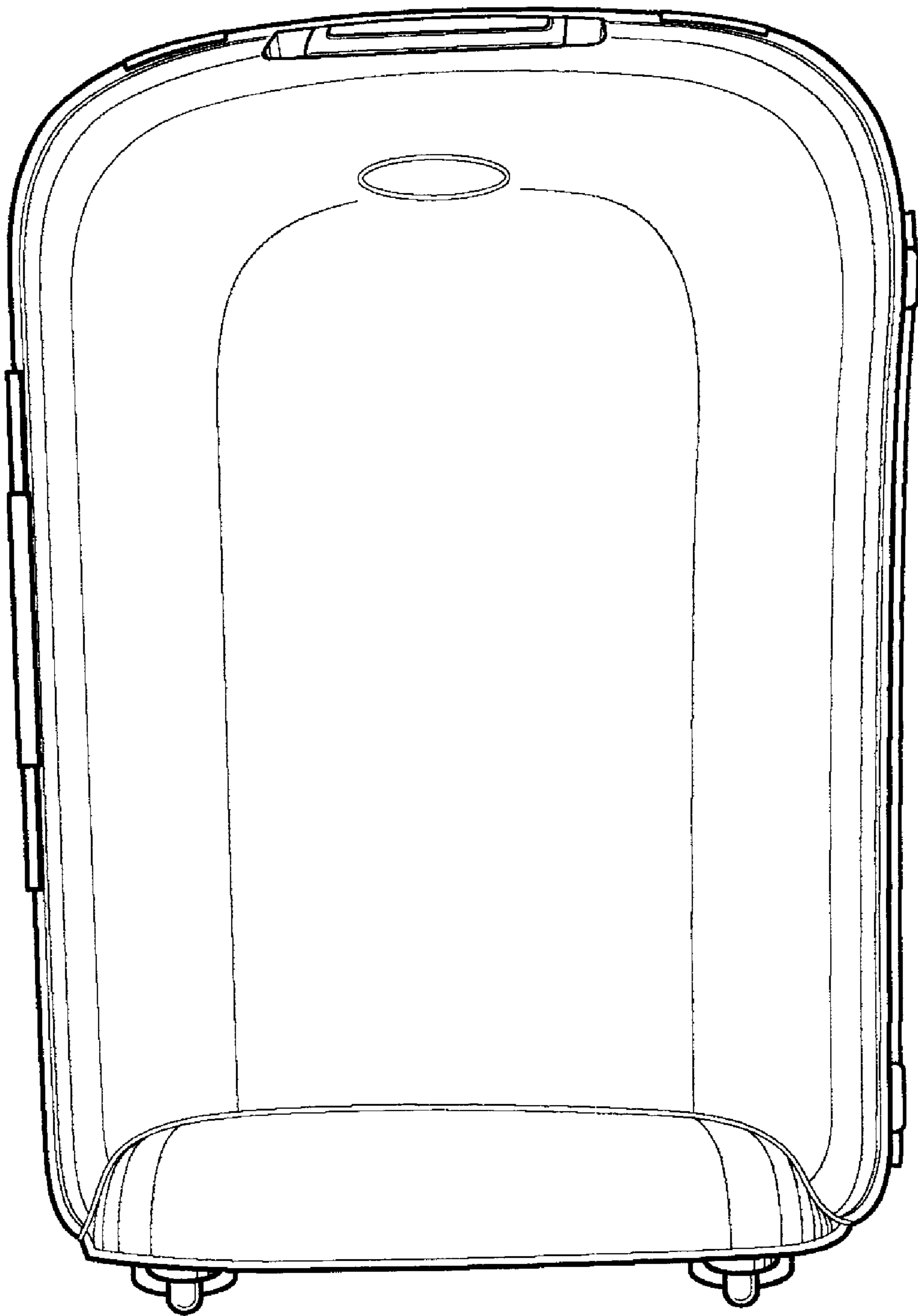

FIG. 6

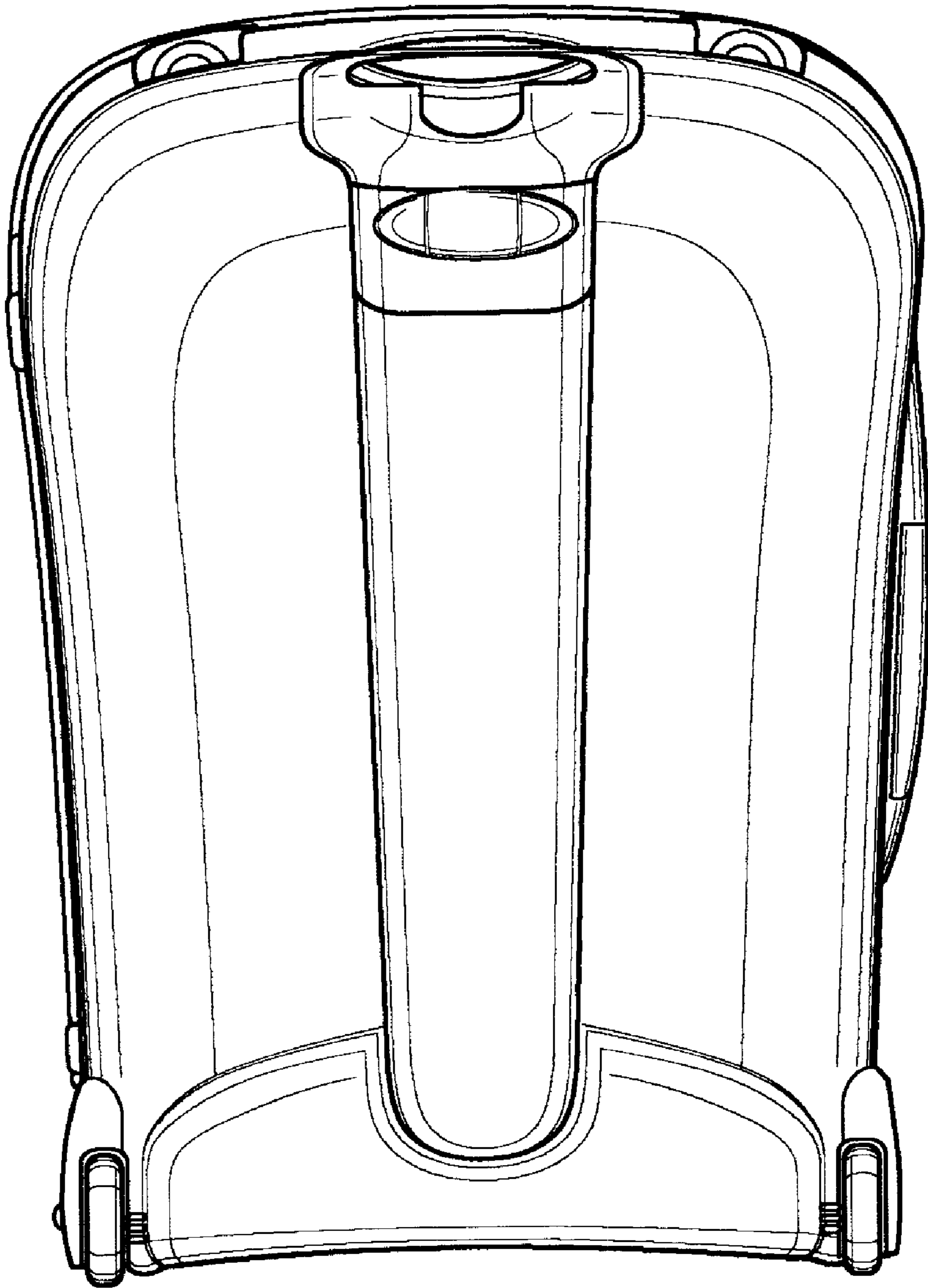

FIG. 7

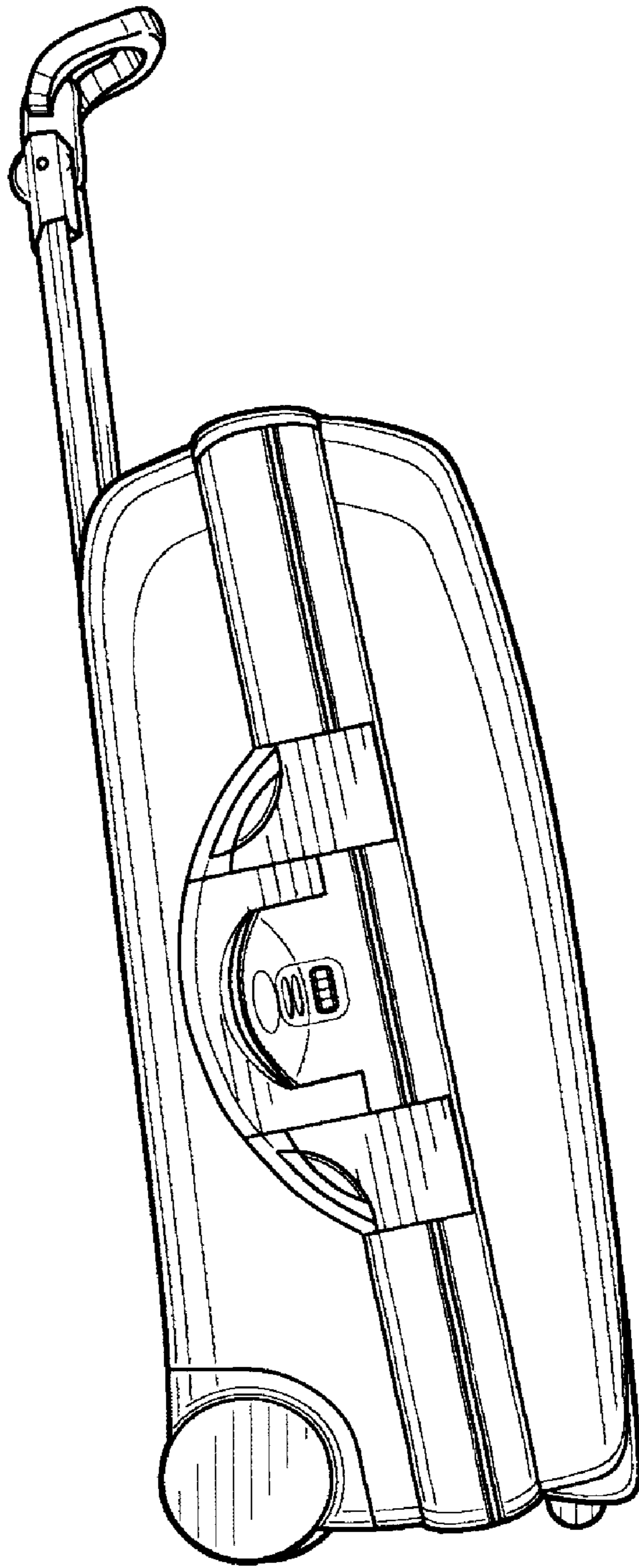

FIG. 8