



US00D462145S

(12) **United States Design Patent**
Abzakh

(10) **Patent No.:** **US D462,145 S**

(45) **Date of Patent:** **** Aug. 27, 2002**

(54) **INFLATABLE SUITE WITH ATTACHED LIFE-SAVING DEVICES**

(76) **Inventor:** **Marwan Abzakh**, 3462 Kanasa Ave.,
Riverside, CA (US) 92507

(**) **Term:** **14 Years**

(21) **Appl. No.:** **29/150,756**

(22) **Filed:** **Nov. 20, 2001**

(51) **LOC (7) Cl.** **29-02**

(52) **U.S. Cl.** **D29/100; D29/124; D21/804**

(58) **Field of Search** **D29/100, 101.1, D29/124; D21/801, 804, 805; D2/732; 2/456-458, 2.11, 2.15, 2.16, 2.17; 441/88, 89, 102, 103, 104, 105; 128/202.11, 201.27**

(56) **References Cited**

U.S. PATENT DOCUMENTS

1,220,625	A	*	3/1917	Grudzienski	441/89
3,675,244	A	*	7/1972	Mayo et al.	2/2.16
4,062,079	A		12/1977	Potter		
D271,915	S	*	12/1983	Bengtson	D2/732
4,638,791	A		1/1987	Krogh et al.		
4,881,539	A		11/1989	Pasternack		
5,072,727	A		12/1991	Aronne		
5,136,721	A	*	8/1992	Farnworth et al.	2/2.17
5,226,410	A		7/1993	Fournol		
5,314,402	A		5/1994	Foote et al.		

5,458,516	A	*	10/1995	Uglene et al.	441/102
5,647,059	A	*	7/1997	Uglene et al.	2/2.15
5,893,786	A	*	4/1999	Stevens	441/89
6,010,470	A		1/2000	Albery et al.		
6,209,144	B1	*	4/2001	Carter	2/458

* cited by examiner

Primary Examiner—Lucy Lieberman

(74) *Attorney, Agent, or Firm*—John D. Gugliotta

(57) **CLAIM**

The ornamental design for a inflatable suit with attached life-saving devices, as shown and described.

DESCRIPTION

FIG. 1 is a front view of an inflatable suit with attached life-saving devices showing my new design;
 FIG. 2 is a front view with the leg coverings in a different position;
 FIG. 3 is a rear view of FIG. 2;
 FIG. 4 is a top view of FIG. 2;
 FIG. 5 is a bottom view of FIG. 2;
 FIG. 6 is a side view as seen from the right of FIG. 2; and,
 FIG. 7 is a side view as seen from the left of FIG. 2.
 The hand coverings are shown in an alternate position in FIGS. 4, 5, 6 and 7. The flag is shown in alternate positions in FIGS. 4, 5, 6 and 7. FIGS. 2 and 3 in the drawings are shown on a reduced scale.

1 Claim, 4 Drawing Sheets

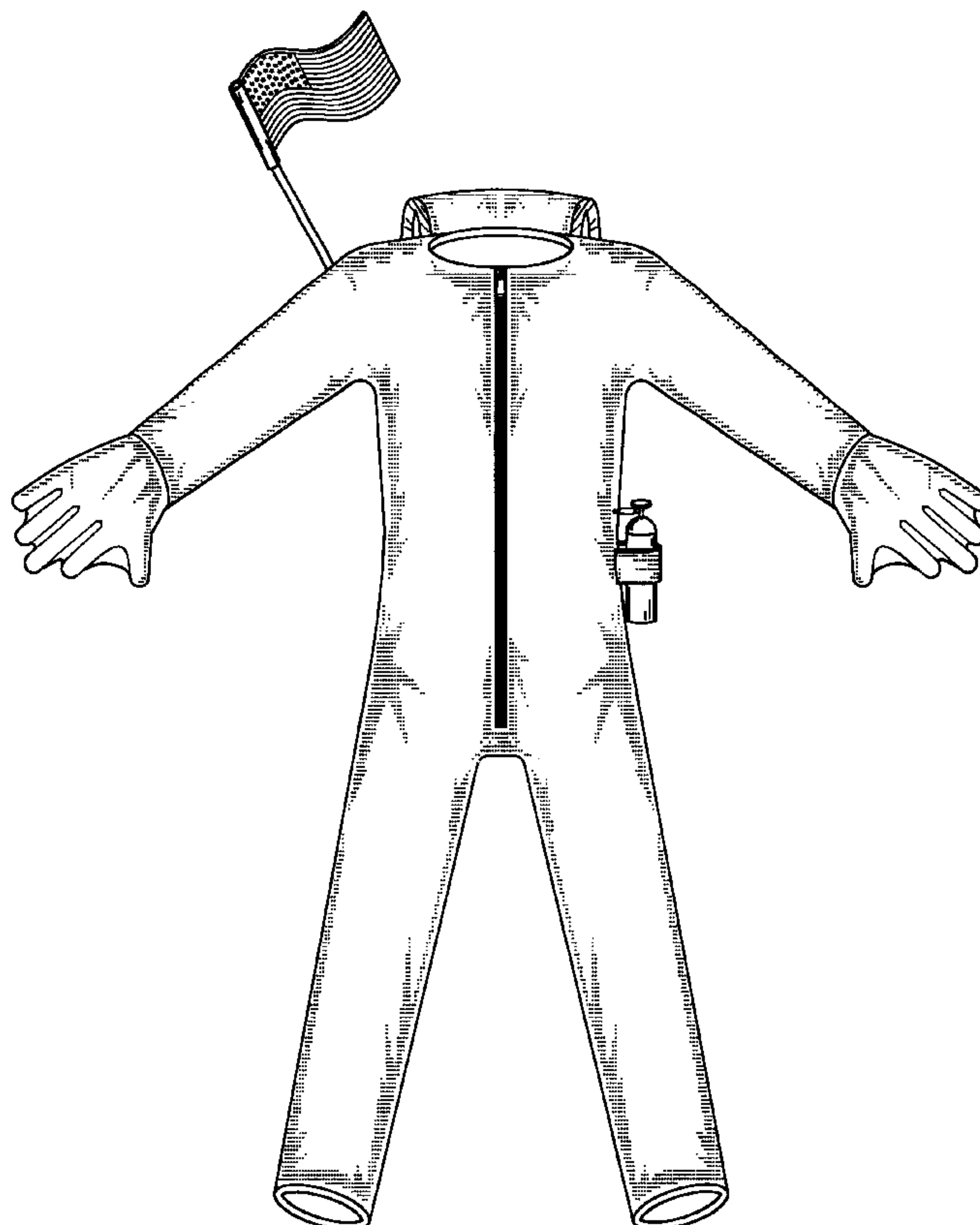

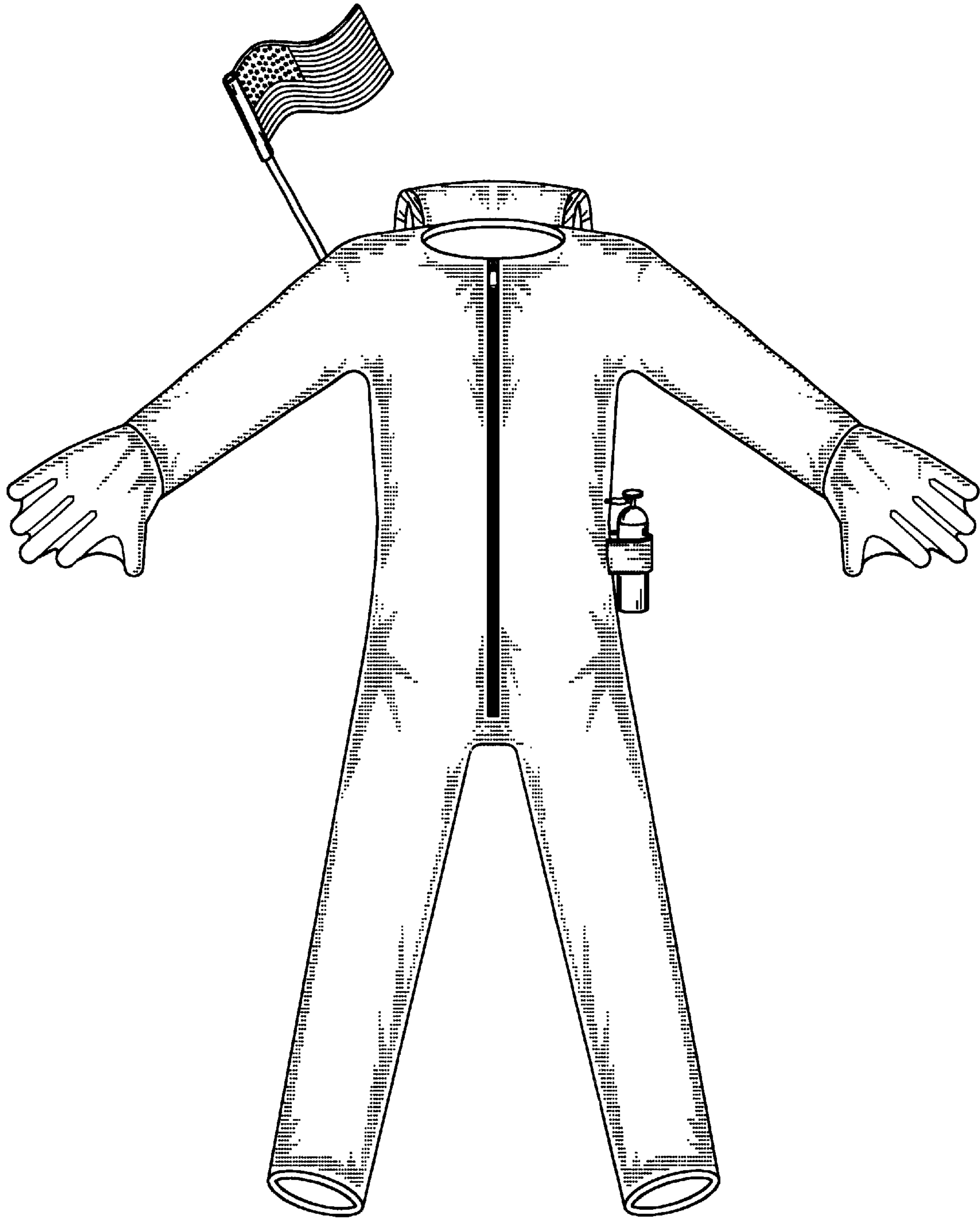

Figure 1

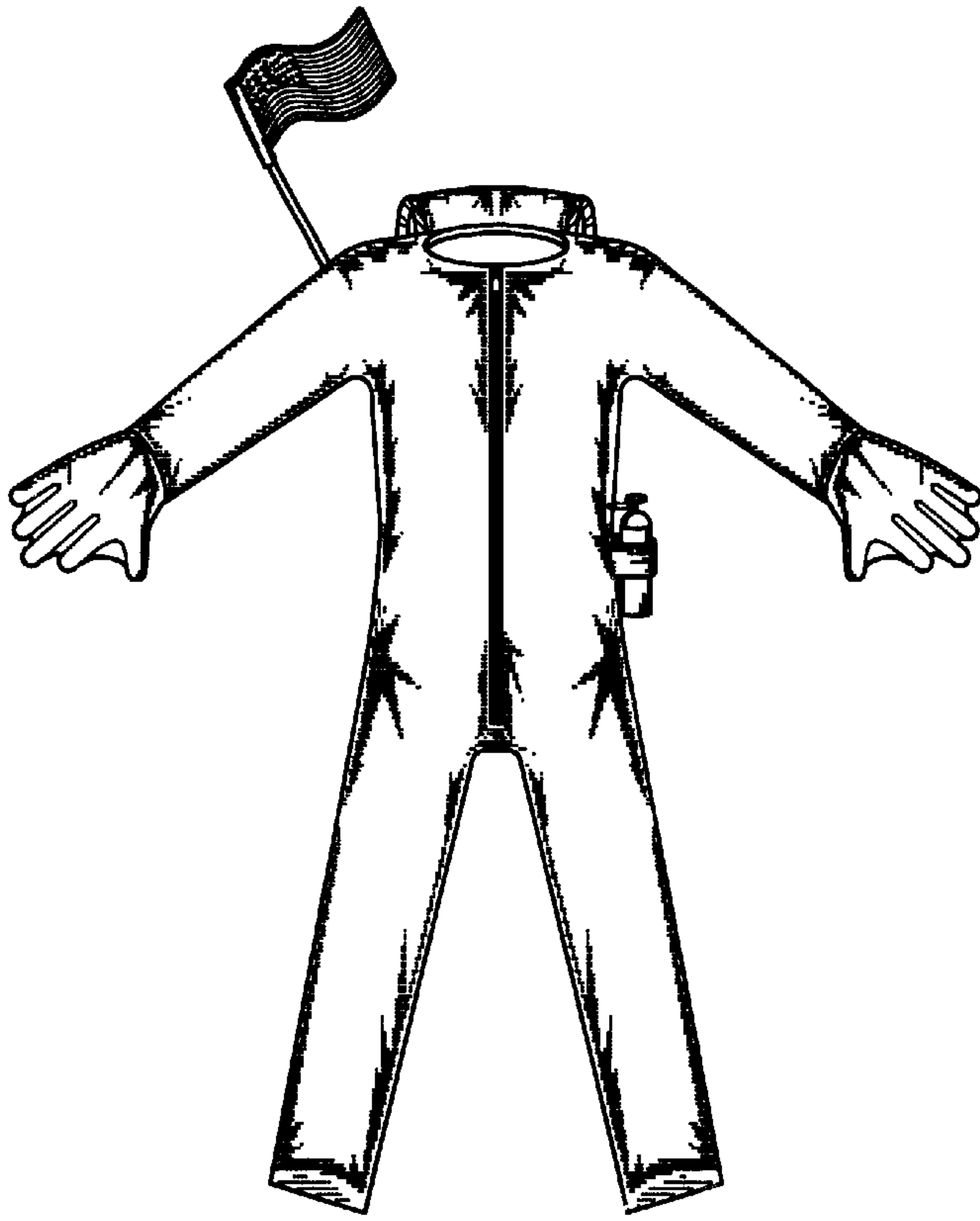

Figure 2

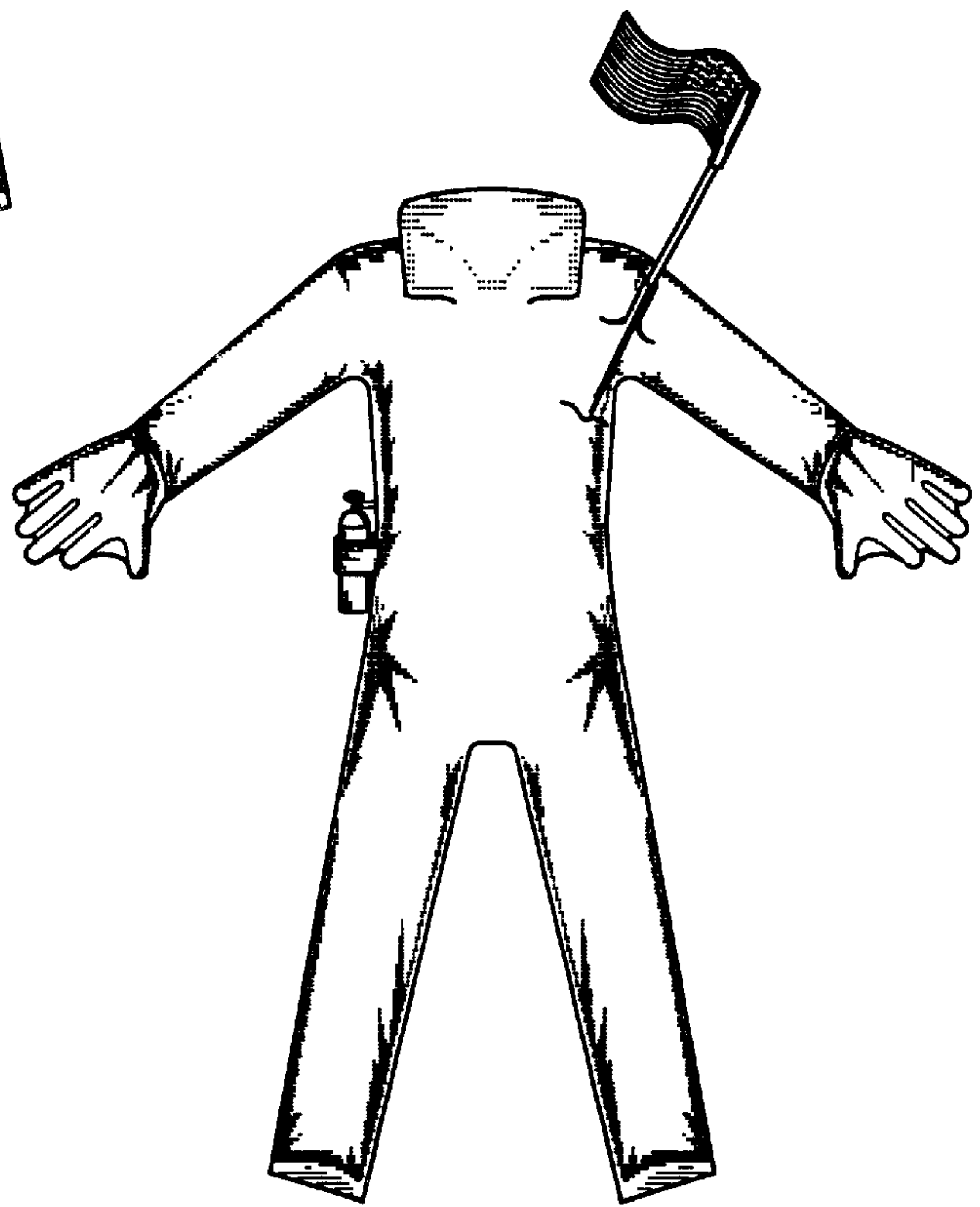

Figure 3

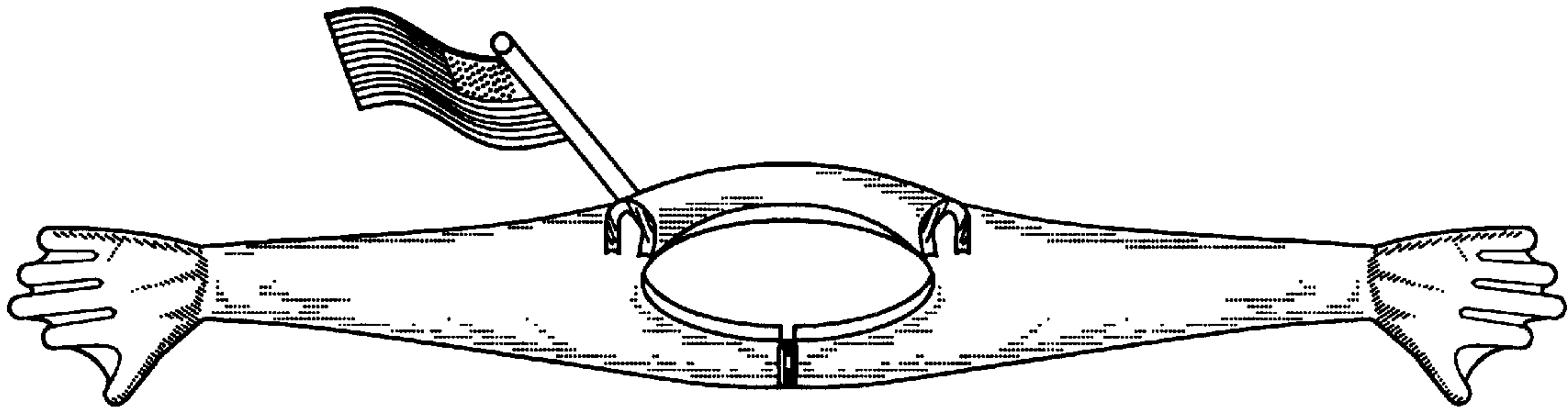

Figure 4

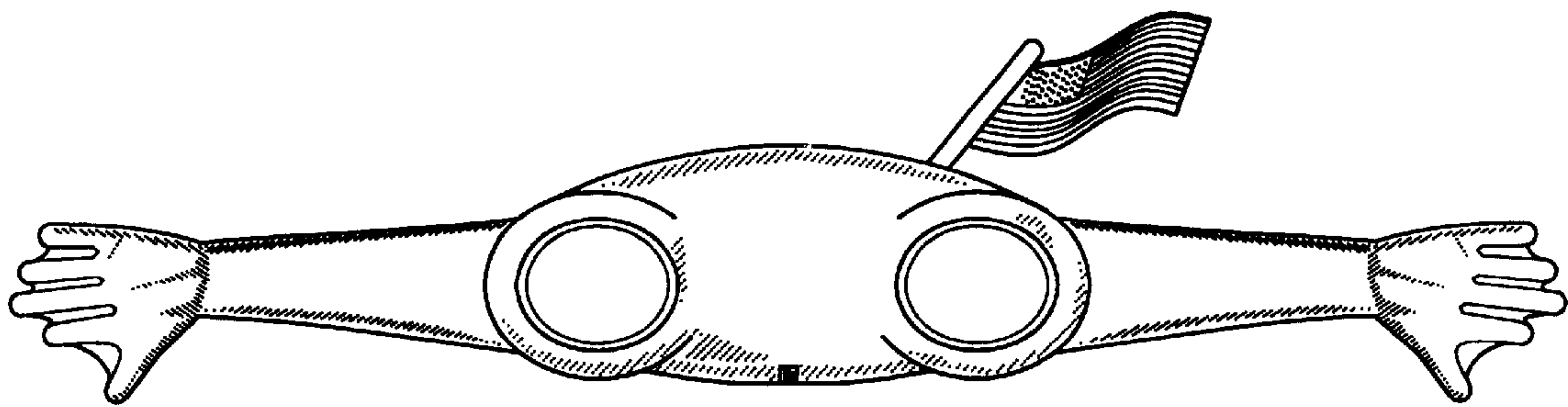

Figure 5

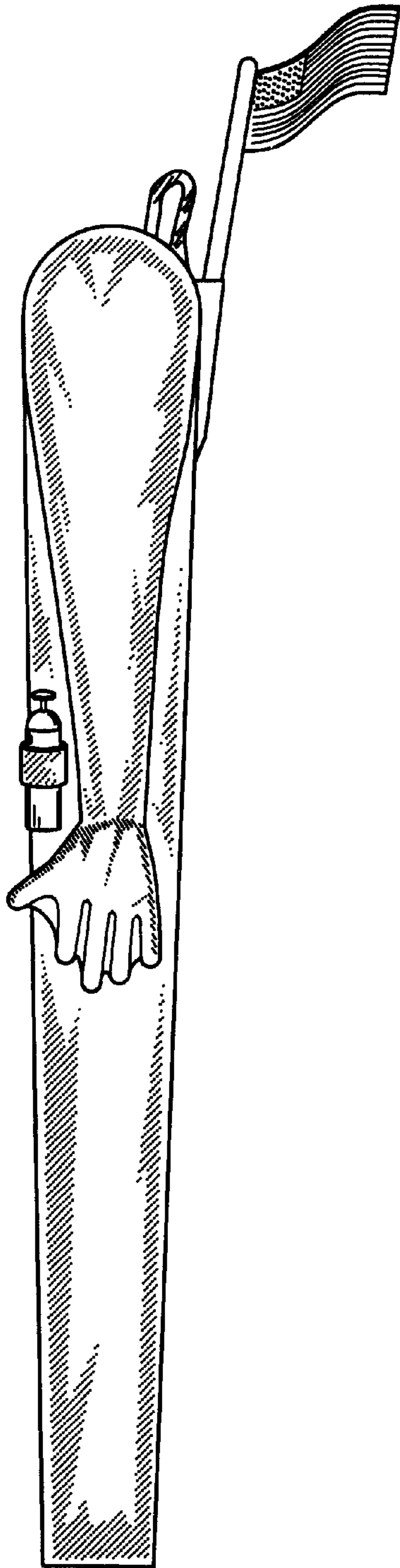

Figure 6

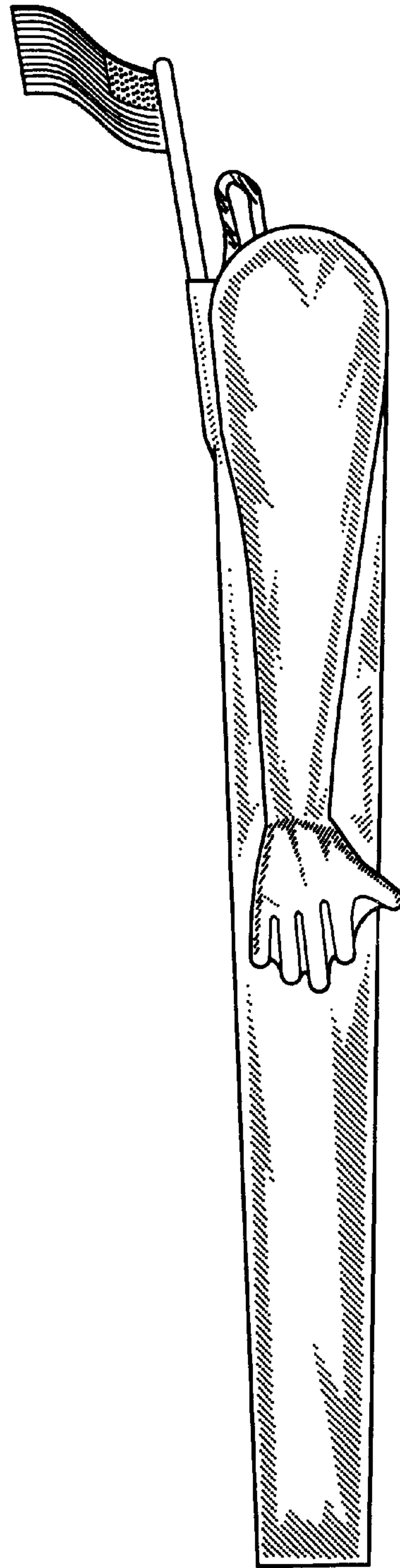

Figure 7