



US00D462100S

(12) **United States Design Patent**  
**Breier et al.**

(10) **Patent No.: US D462,100 S**

(45) **Date of Patent: \*\* \*Aug. 27, 2002**

(54) **MULTIPLE COMPONENT PUTTER HEAD**

(75) Inventors: **Joshua G. Breier**, San Marcos;  
**Augustin W. Rollinson**, San Diego;  
**Ronald K. Hettinger**, Oceanside, all of  
CA (US)

(73) Assignee: **Callaway Golf Company**, Carlsbad,  
CA (US)

(\* ) Notice: This patent is subject to a terminal dis-  
claimer.

(\*\* ) Term: **14 Years**

(21) Appl. No.: **29/146,143**

(22) Filed: **Aug. 3, 2001**

**Related U.S. Application Data**

(63) Continuation-in-part of application No. 29/131,010, filed on  
Oct. 11, 2000, now Pat. No. Des. 443,320.

(51) **LOC (7) Cl.** ..... **21-02**

(52) **U.S. Cl.** ..... **D21/743**

(58) **Field of Search** ..... D21/736-746;  
473/251-256, 327, 329-340, 341

(56) **References Cited**

**U.S. PATENT DOCUMENTS**

D207,227 S \* 3/1967 Solheim ..... D21/739

D207,228 S \* 3/1967 Solheim ..... D21/743  
D380,246 S \* 6/1997 Solheim et al. .... D21/736  
D389,207 S \* 1/1998 Cameron ..... D21/742  
D402,343 S \* 12/1998 Helstetter et al. .... D21/738  
D410,267 S \* 5/1999 Solheim et al. .... D21/736  
D411,271 S \* 6/1999 Nelson ..... D21/738  
D426,599 S \* 6/2000 Morgan et al. .... D21/736  
D428,086 S \* 7/2000 Solheim ..... D21/743  
D429,297 S \* 8/2000 Hettinger ..... D21/744  
D438,273 S \* 2/2001 Sizemore et al. .... D21/736

\* cited by examiner

*Primary Examiner*—Mitchell Siegel  
(74) *Attorney, Agent, or Firm*—Michael A. Catania

(57) **CLAIM**

The ornamental design for a multiple component putter  
head, as shown and described.

**DESCRIPTION**

FIG. 1 is a left perspective view of a multiple component  
putter head;  
FIG. 2 is a top plan view thereof;  
FIG. 3 is a front view thereof;  
FIG. 4 is a rear view thereof;  
FIG. 5 is a toe end view thereof;  
FIG. 6 is a heel end view thereof; and,  
FIG. 7 is a bottom plan view thereof.

**1 Claim, 2 Drawing Sheets**

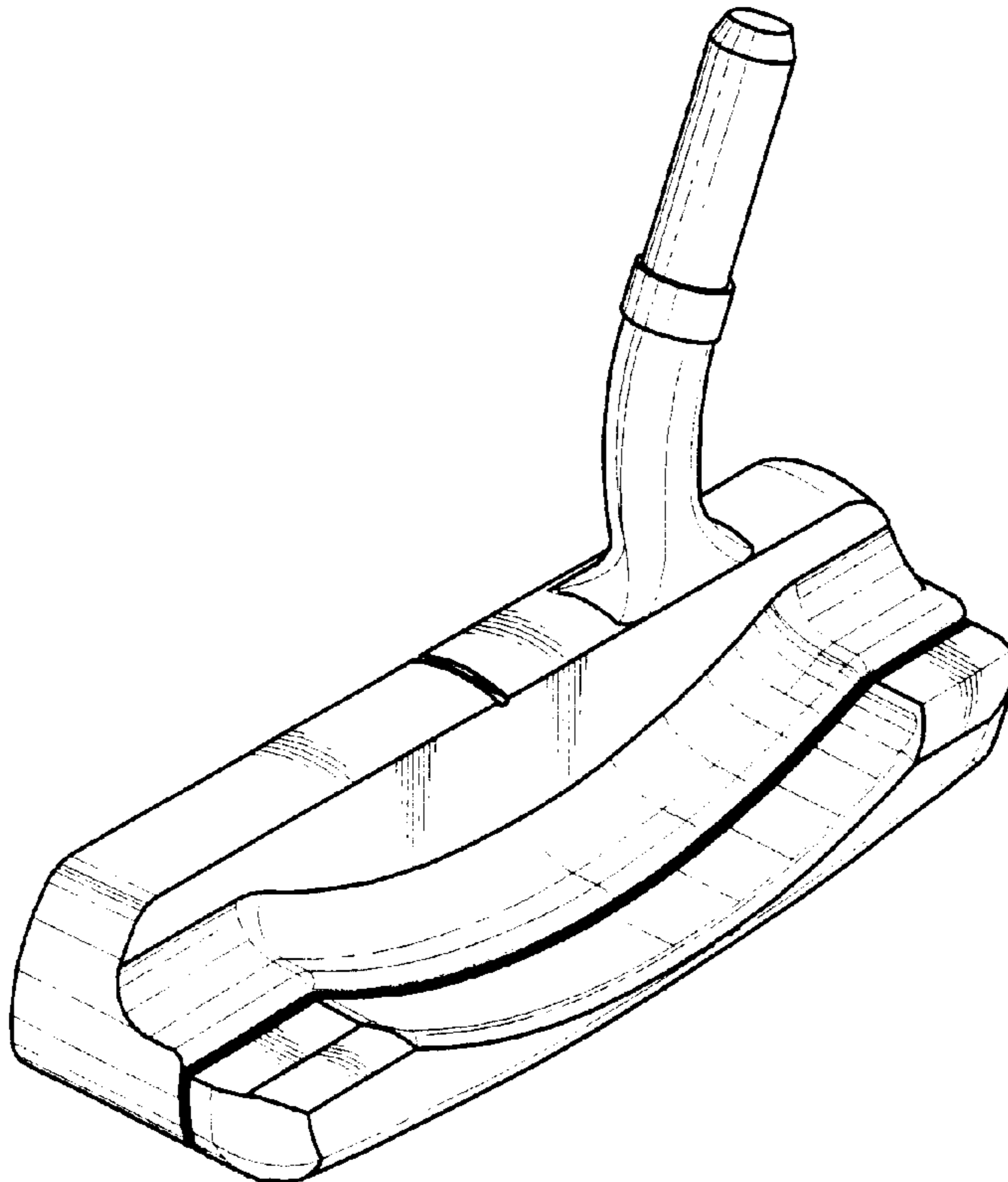

*FIG. 1*

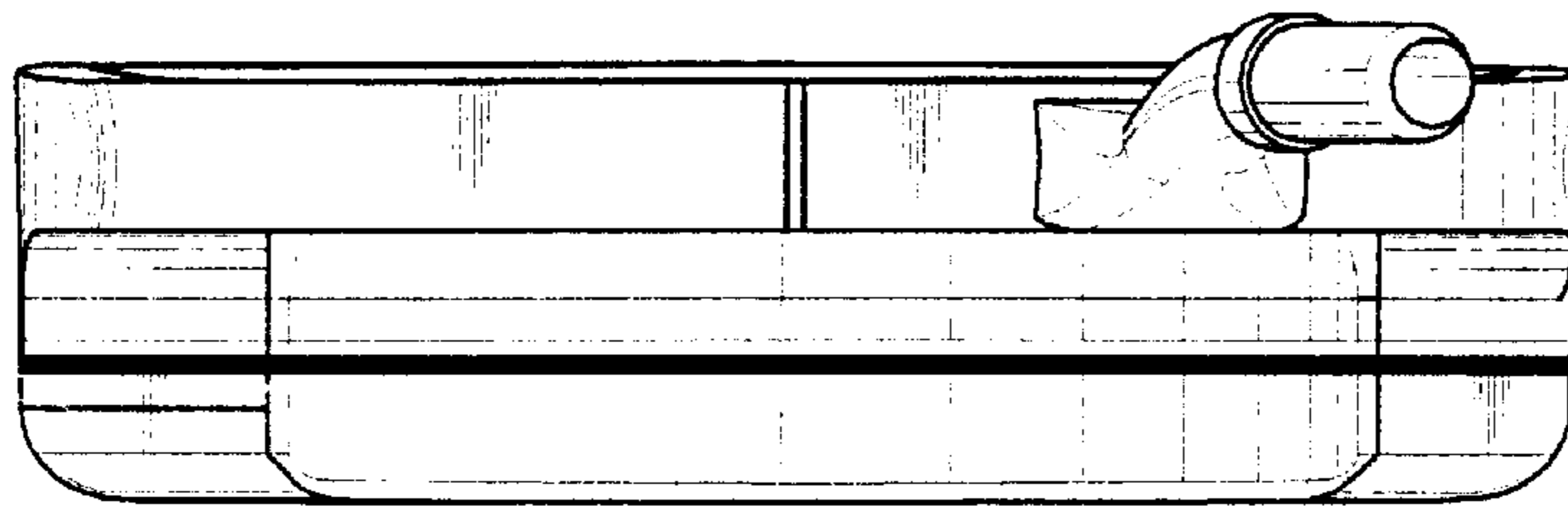
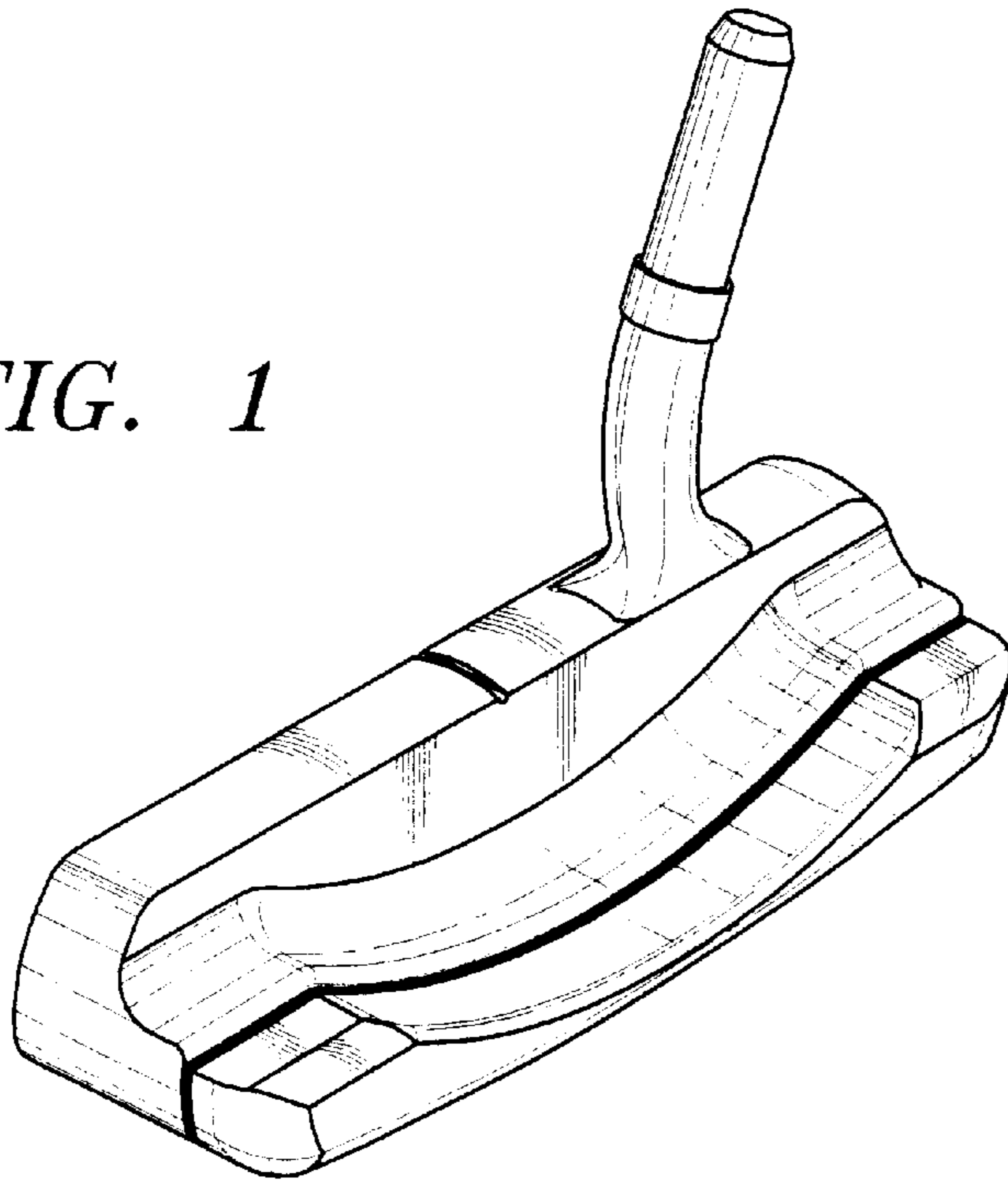

*FIG. 2*

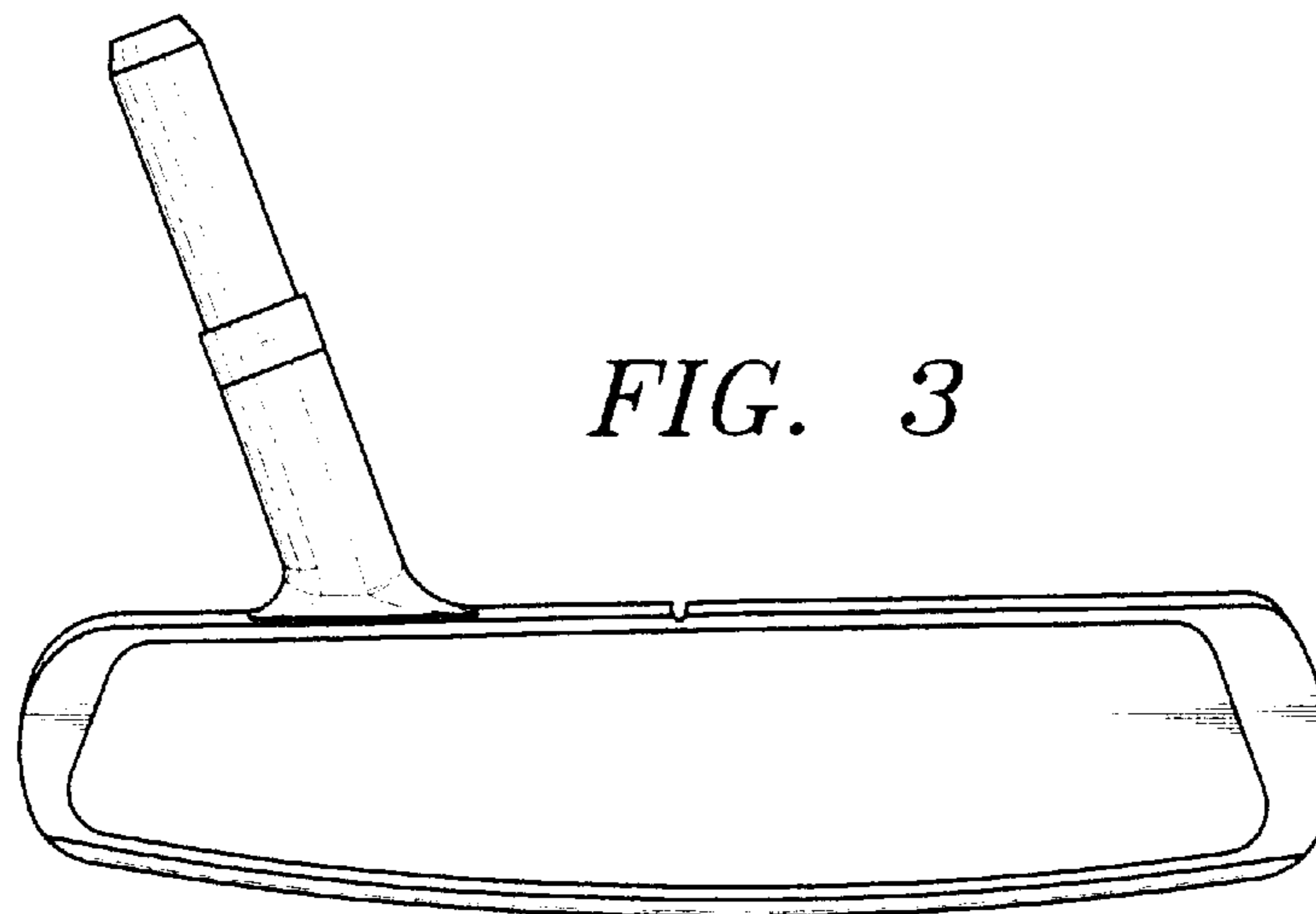

*FIG. 3*

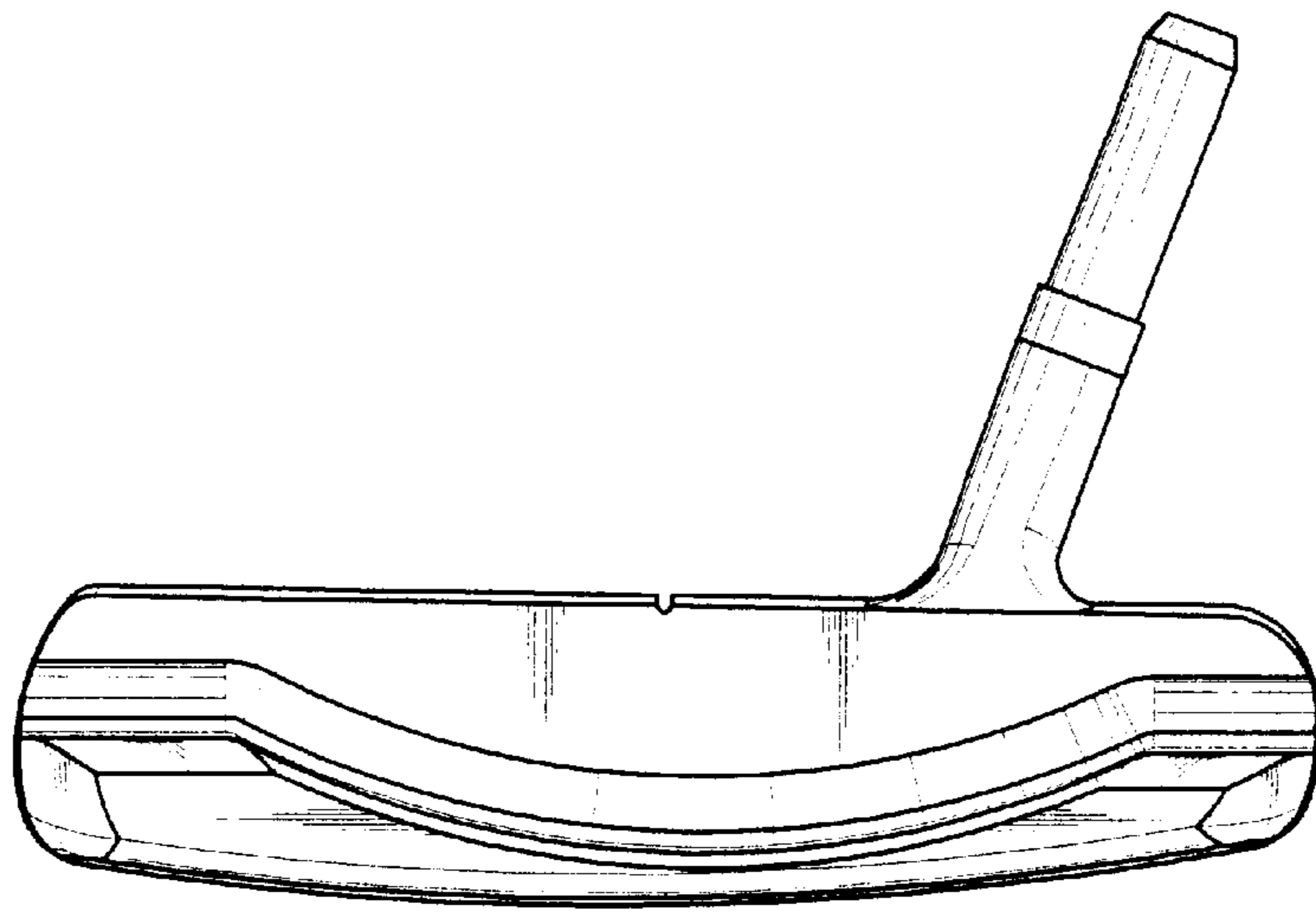

FIG. 4

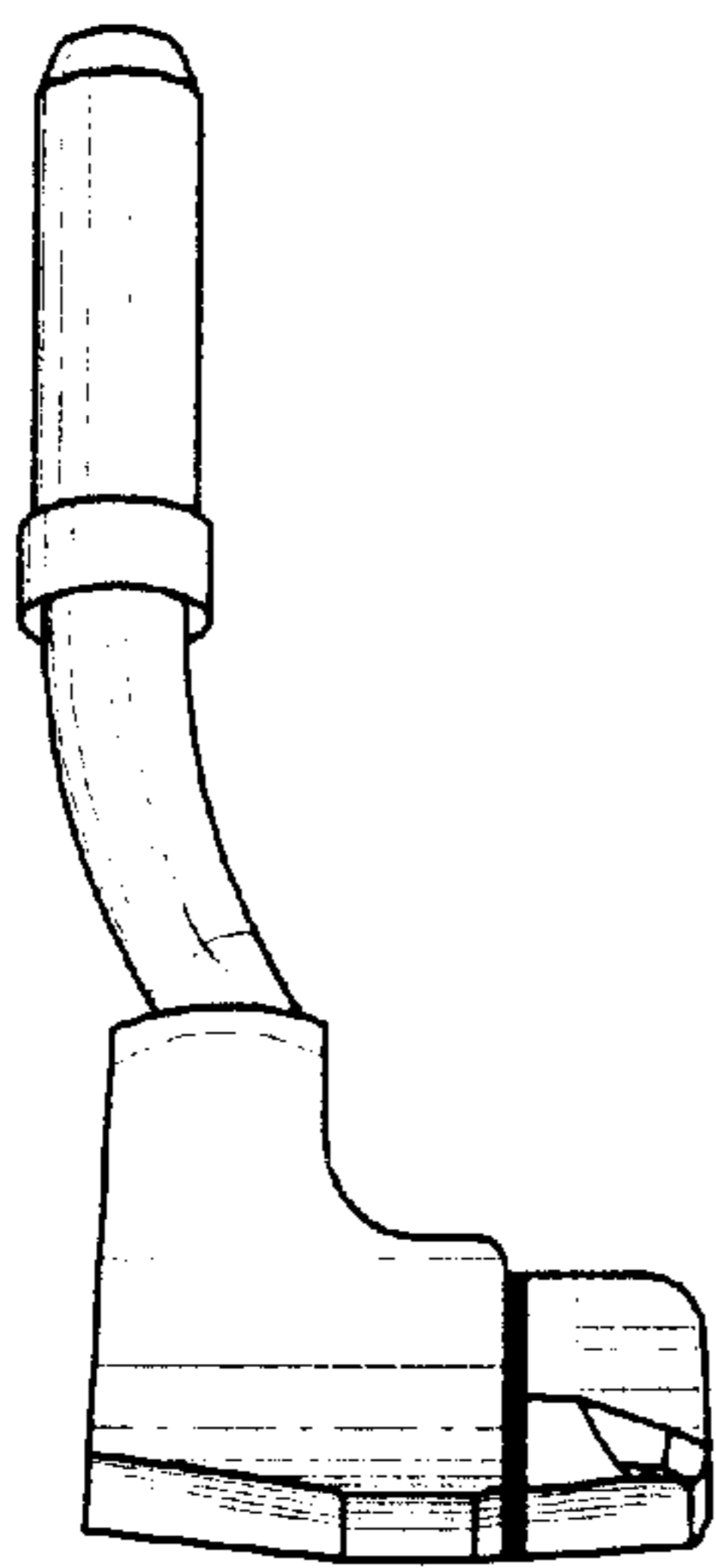

FIG. 5

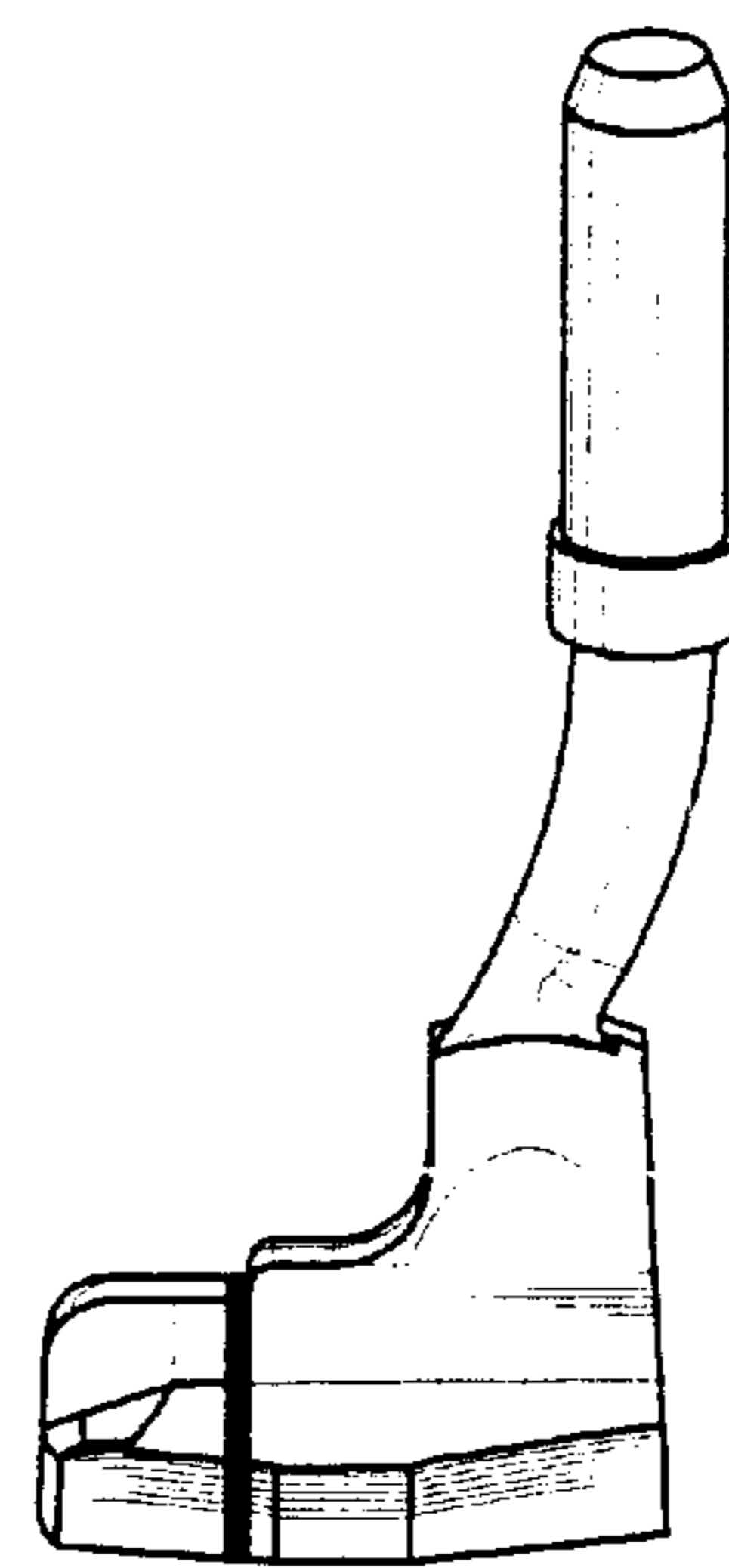

FIG. 6

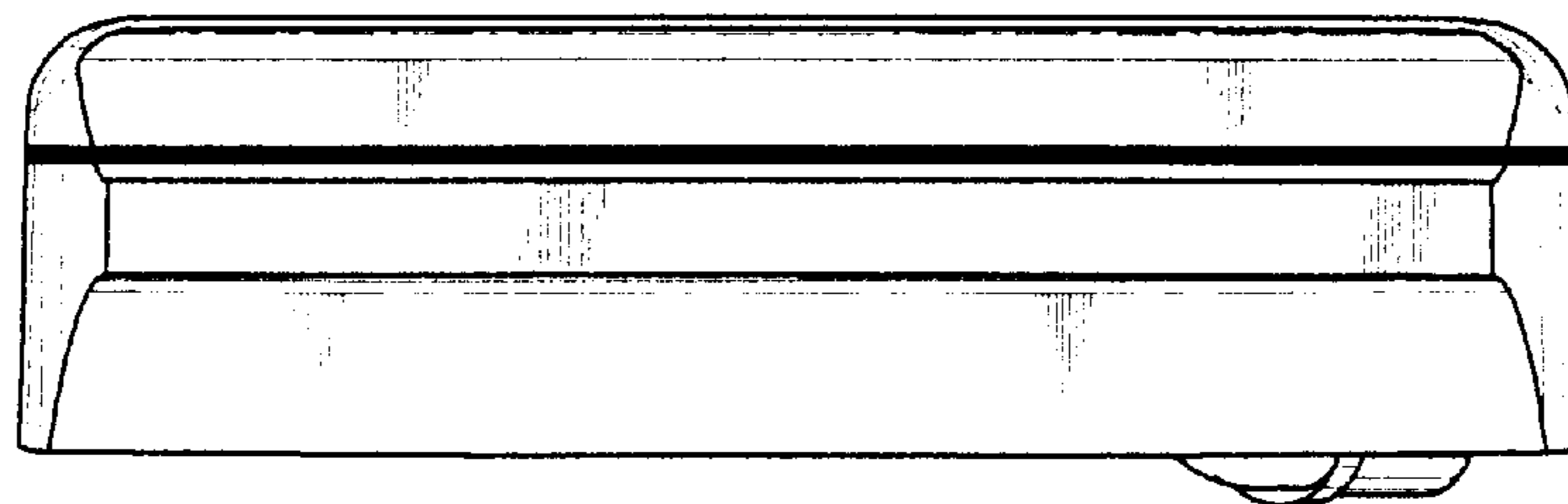

FIG. 7