



US00D461840S

(12) **United States Design Patent**
Perkitny et al.

(10) **Patent No.:** **US D461,840 S**

(45) **Date of Patent:** **** Aug. 20, 2002**

(54) **COIN SORTER DOOR**

(75) Inventors: **Jerzy Perkitny**, Lakewood; **William J. Knox, Jr.**, Painesville, both of OH (US)

(73) Assignee: **Mag-Nif Incorporated**, Mentor, OH (US)

(**) Term: **14 Years**

(21) Appl. No.: **29/154,364**

(22) Filed: **Nov. 13, 2001**

(51) **LOC (7) Cl.** **18-01**

(52) **U.S. Cl.** **D18/12.1; D99/43**

(58) **Field of Search** D99/34, 35, 36,
D99/37, 43; D18/12.1; 446/9, 10, 11, 12;
453/9

(56) **References Cited**

U.S. PATENT DOCUMENTS

D296,029	S	*	5/1988	Knox	D99/35
D347,929	S	*	6/1994	Perkitny	D99/34
5,474,496	A		12/1995	Perkitny		
D378,464	S	*	3/1997	Perkitny	D99/34
5,827,117	A		10/1998	Naas		
5,976,006	A		11/1999	Snyder		
6,099,401	A		8/2000	Perkitny		
D441,172	S	*	4/2001	Snyder	D99/37

OTHER PUBLICATIONS

Mag-Nif makes it in the U.S.A.! 1999 Brochure, front and back cover pages and pp. 1-18.

* cited by examiner

Primary Examiner—Paula A. Mortimer

(74) *Attorney, Agent, or Firm*—Fay, Sharpe, Fagan, Minnich & McKee, LLP

(57) **CLAIM**

The coin sorter door, as shown and described.

DESCRIPTION

FIG. 1 is a perspective view of a coin sorter employing a door showing our new design;

FIG. 2 is an enlarged perspective view thereof of the door and coin tubes which can be selectively mounted on the door;

FIG. 3 is a right side elevational view thereof;

FIG. 4 is a rear elevational view thereof;

FIG. 5 is a left side elevational view thereof;

FIG. 6 is a front elevational view thereof;

FIG. 7 is a top plan view thereof;

FIG. 8 is a bottom plan view thereof; and,

FIG. 9 is a perspective view thereof without the coin tubes.

The components shown in broken lines in FIGS. 1 and 2 are shown for illustrative purposes only and form no part of the claimed design.

1 Claim, 6 Drawing Sheets

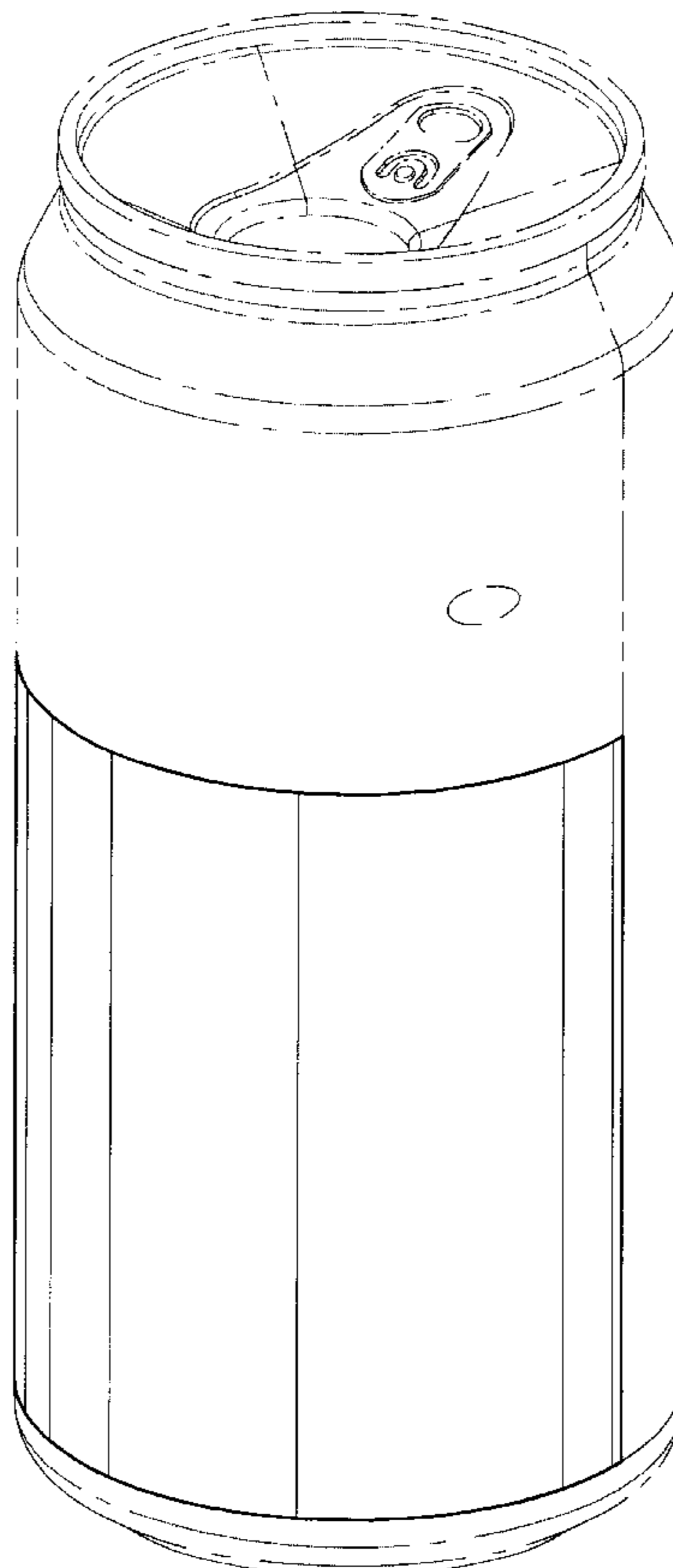

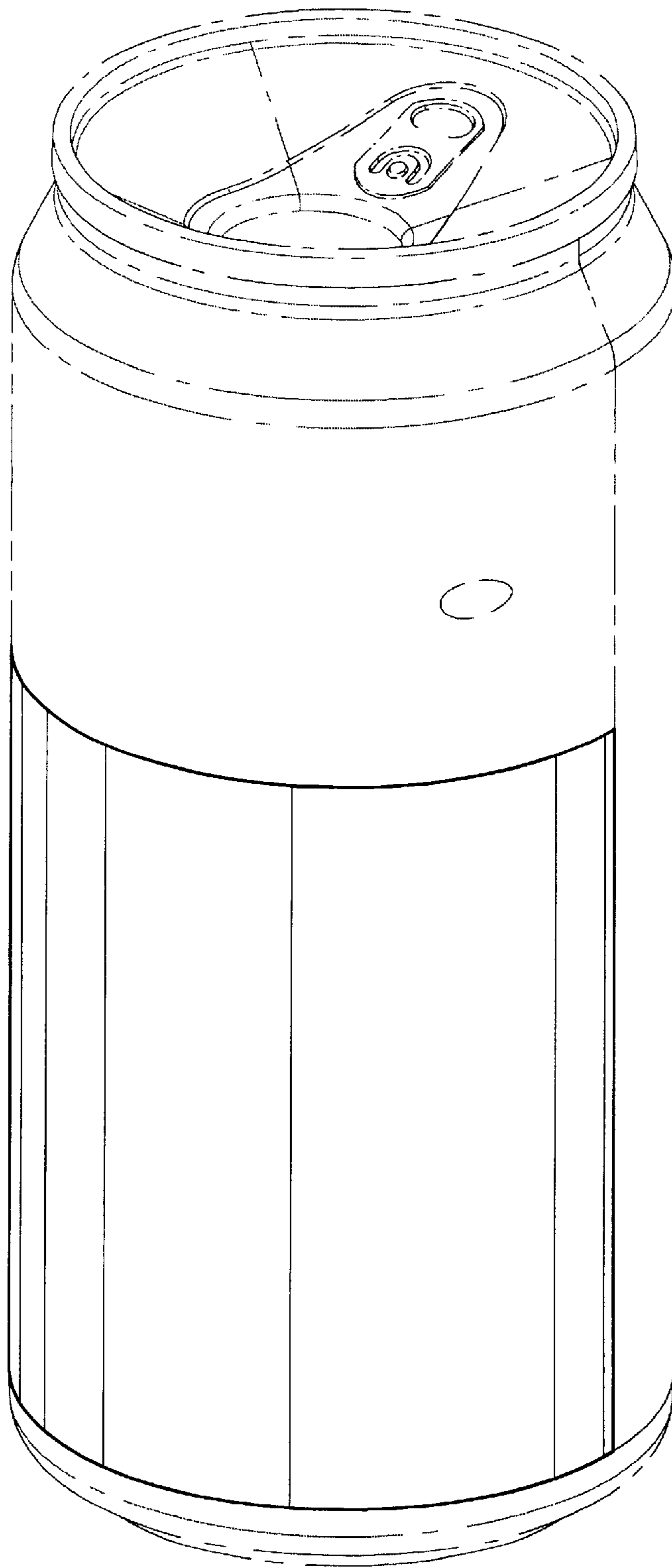

FIG. 1

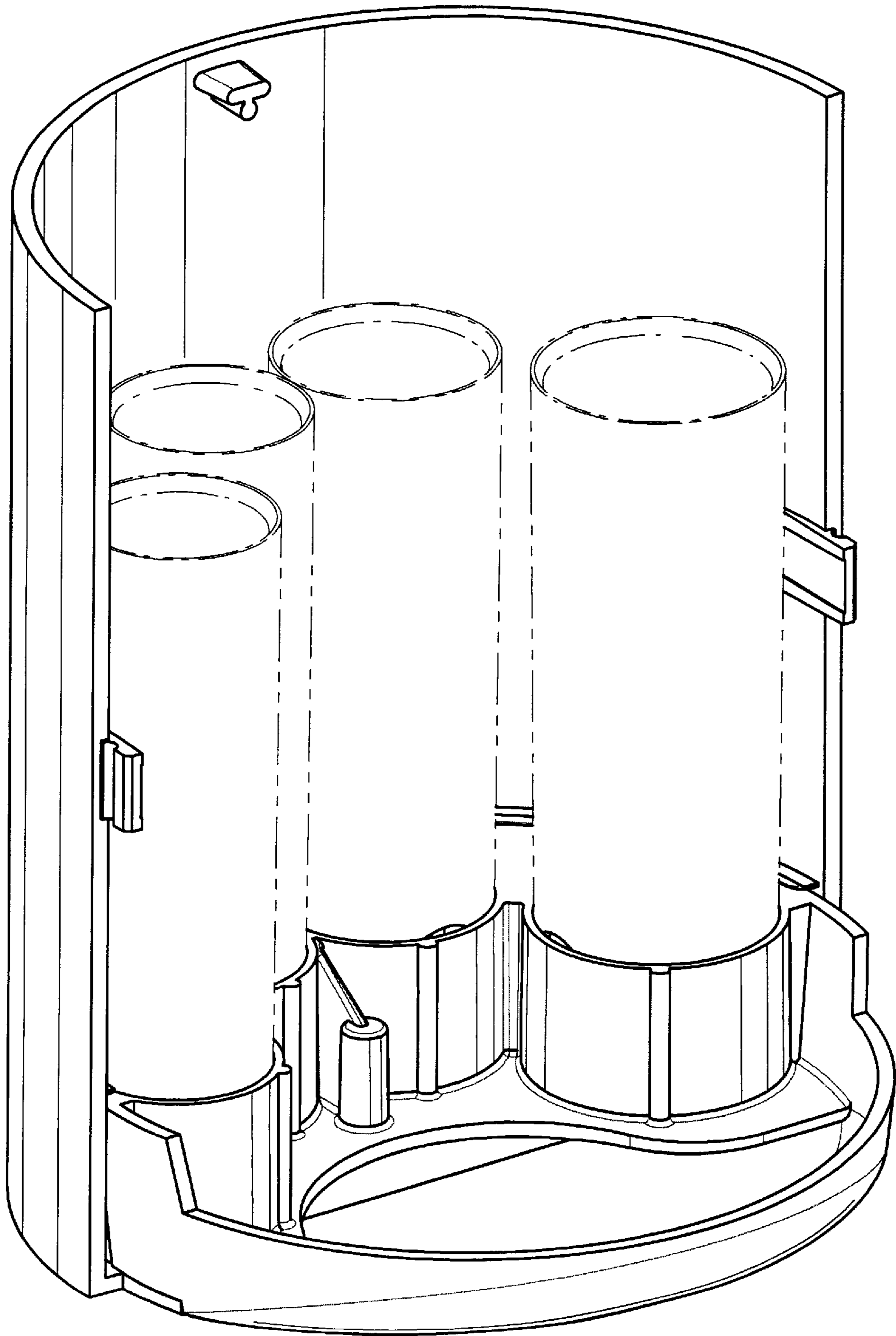

FIG. 2

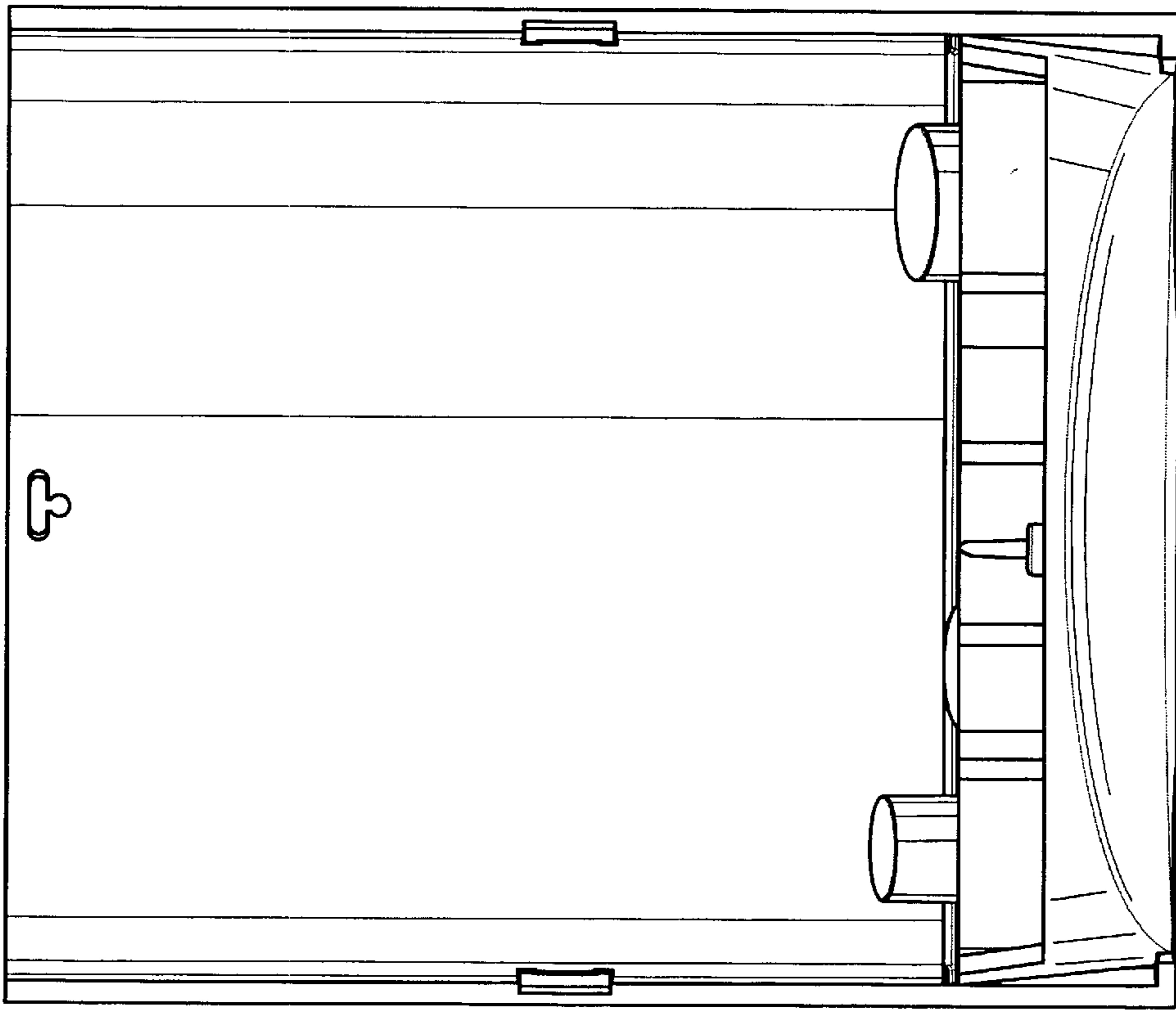

FIG. 4

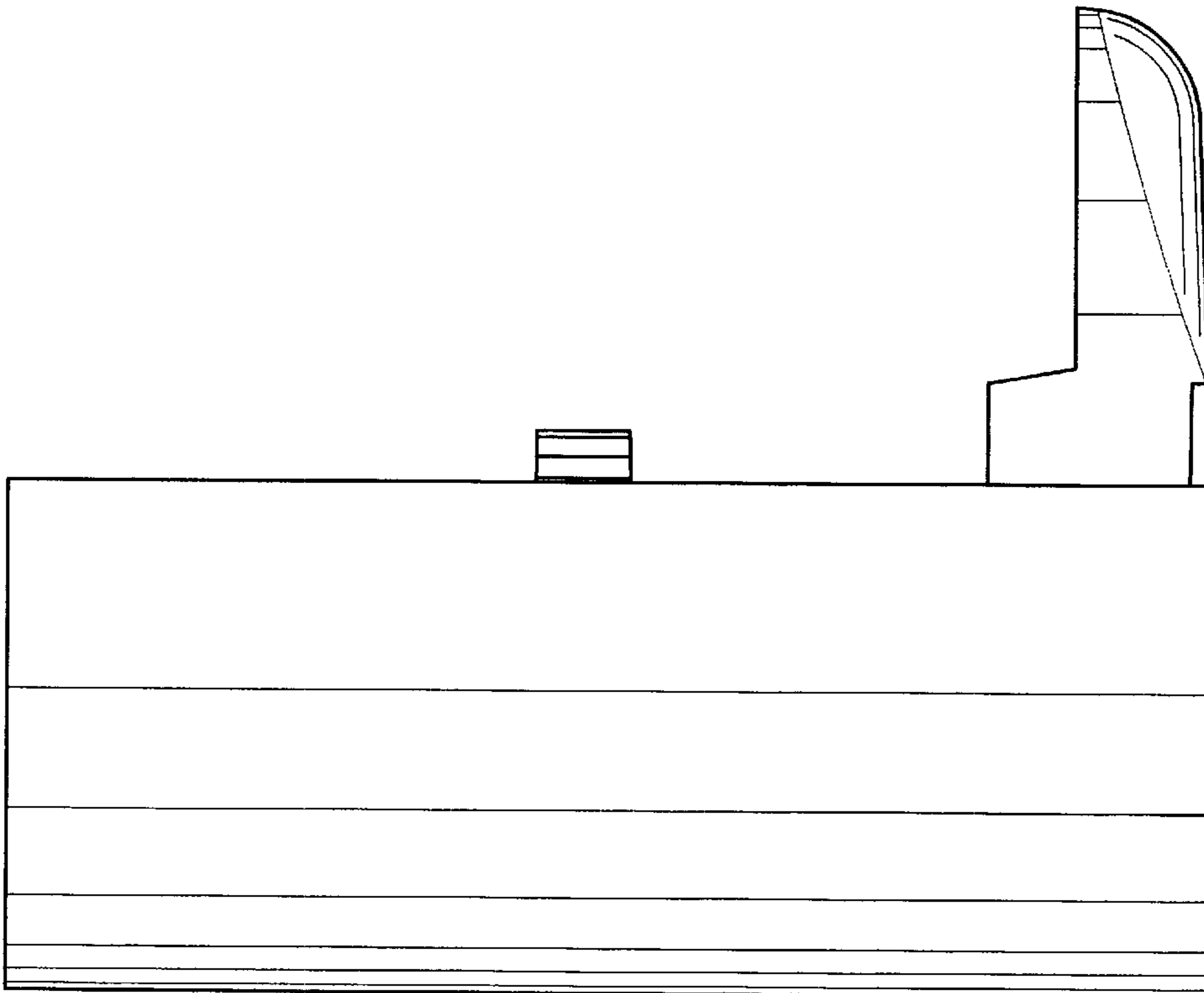

FIG. 3

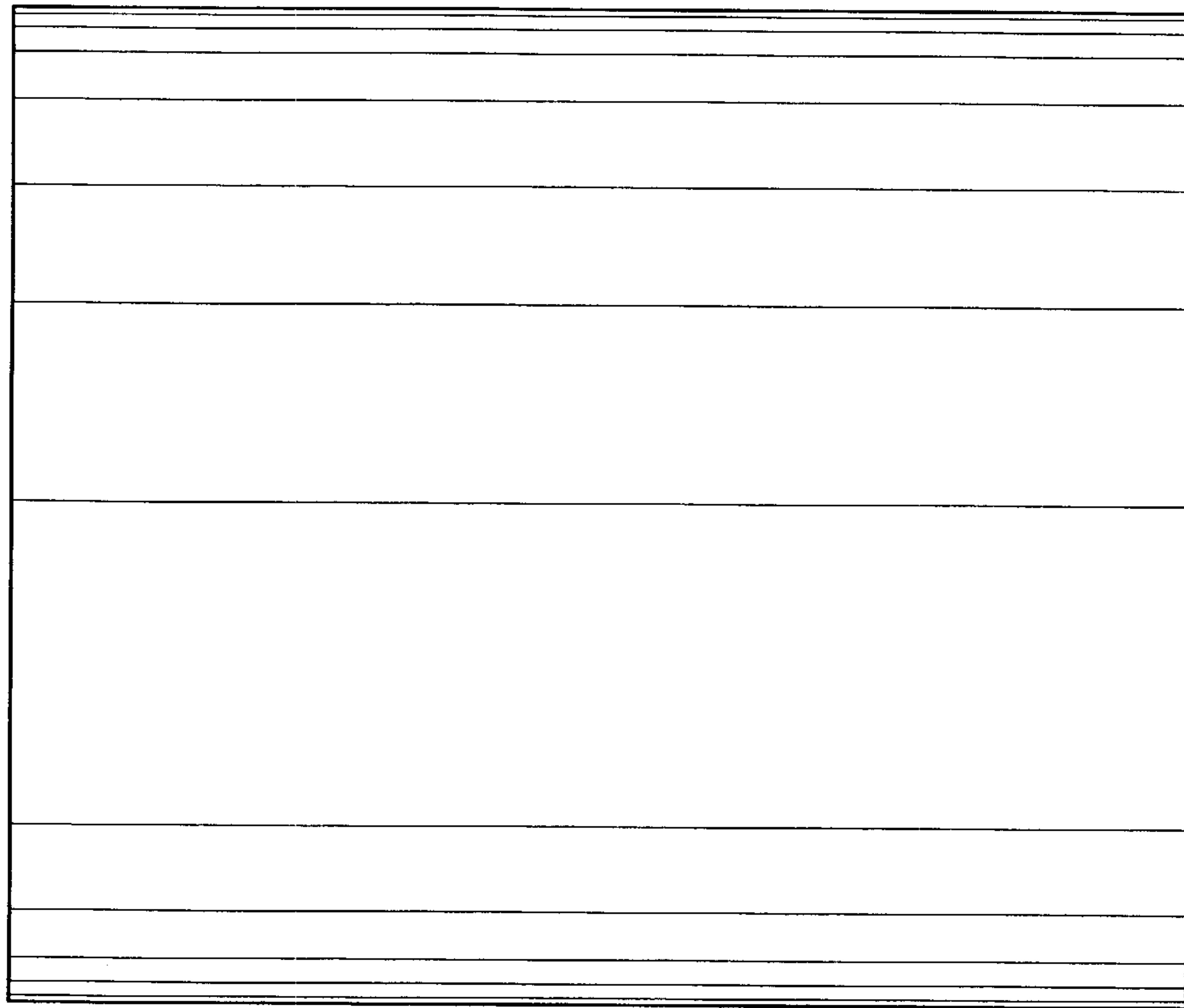

FIG. 6

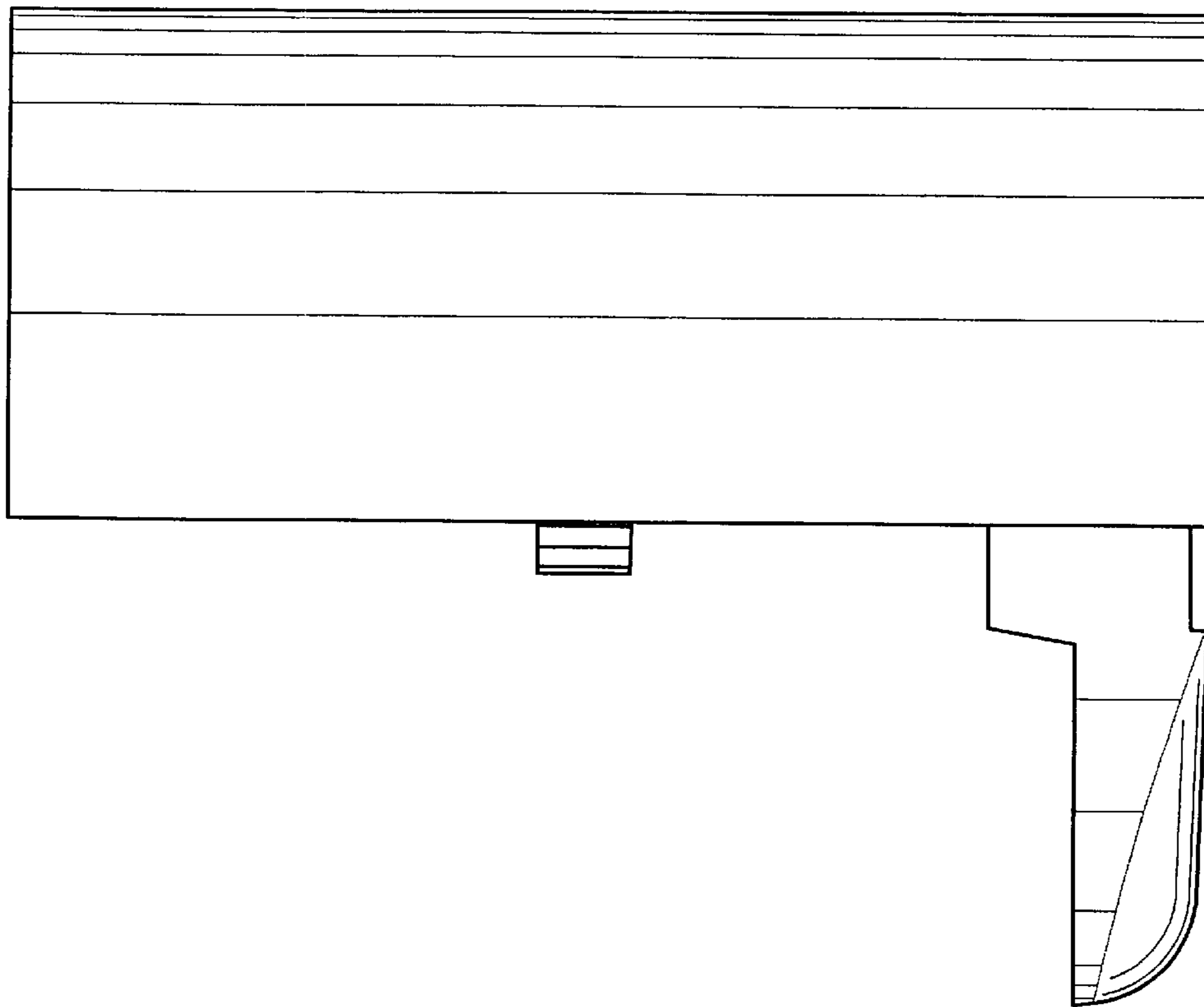

FIG. 5

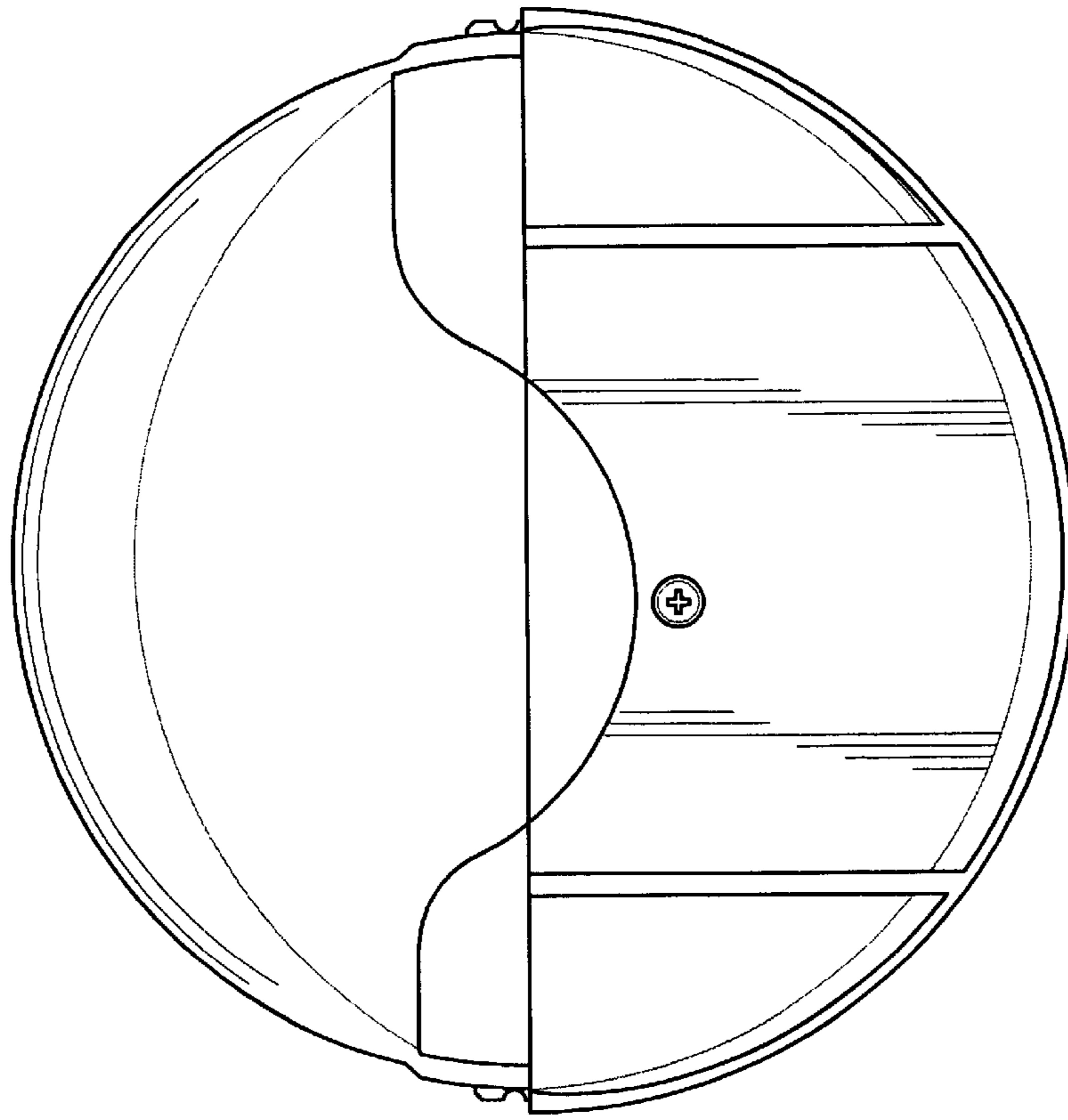

FIG. 8

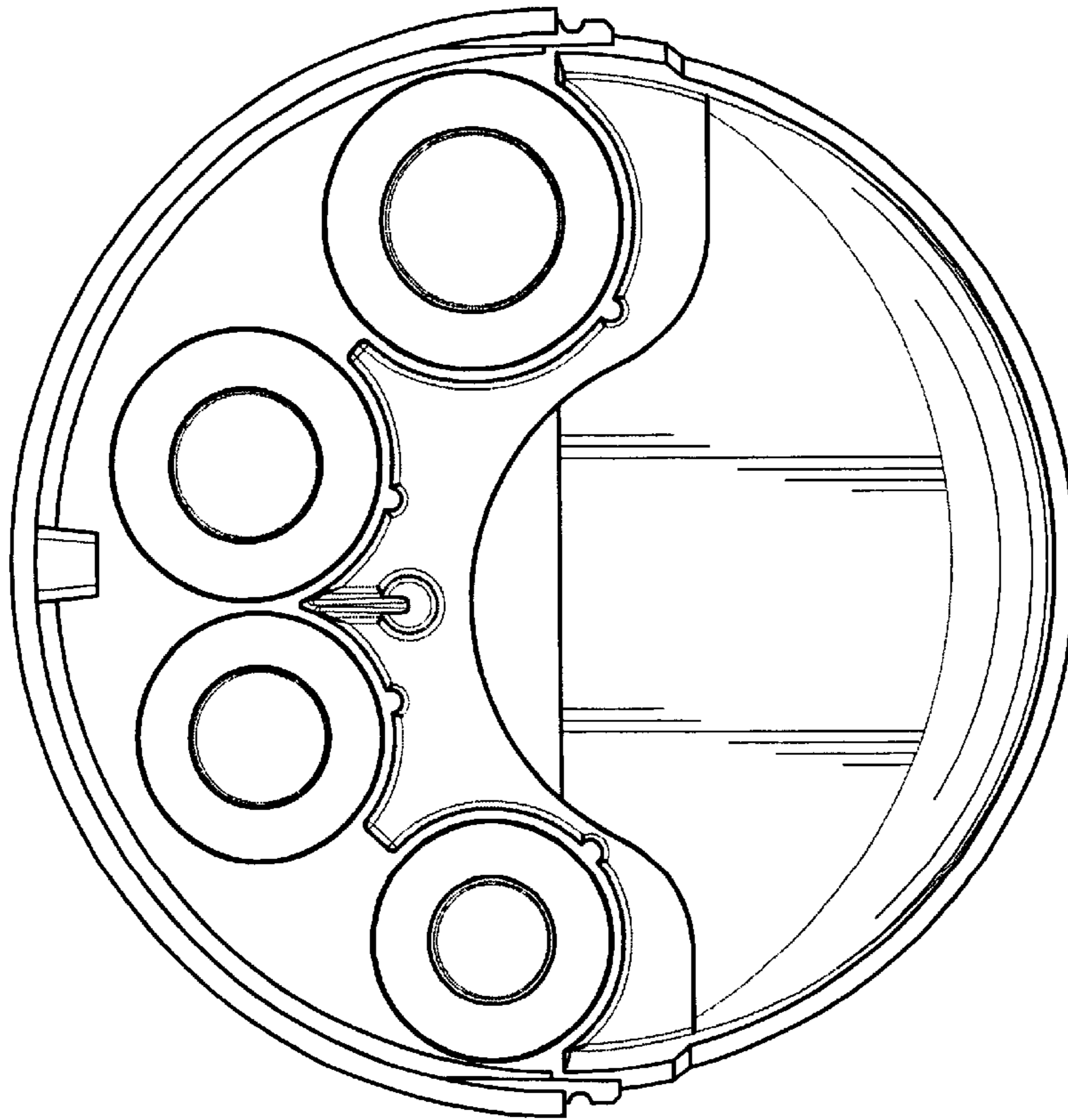

FIG. 7

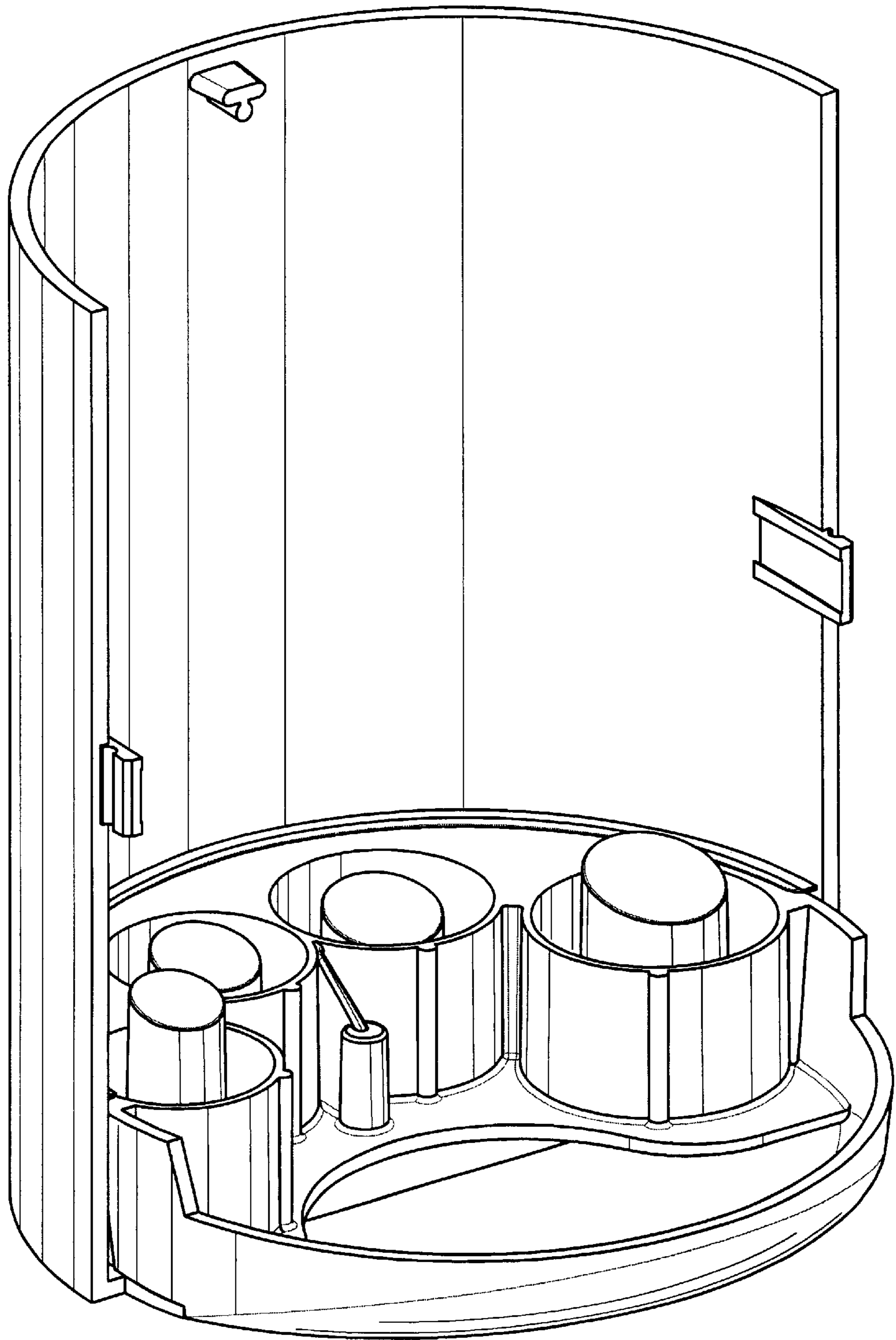

FIG. 9