



US00D461830S

(12) **United States Design Patent**
Stratford et al.

(10) **Patent No.:** **US D461,830 S**

(45) **Date of Patent:** **** Aug. 20, 2002**

(54) **LAWN MOWER**

D390,576 S * 2/1998 Shimamura D15/14
D424,070 S * 5/2000 Danthois D15/14

(75) Inventors: **Mark Stratford**, Darlington; **Nigel Robson**, Newton Hall, both of (GB)

* cited by examiner

(73) Assignee: **Black & Decker Inc.**, Newark, DE (US)

Primary Examiner—Mitchell Siegel

(**) Term: **14 Years**

(74) *Attorney, Agent, or Firm*—Harness, Dickey & Pierce, P.L.C.

(21) Appl. No.: **29/120,648**

(22) Filed: **Mar. 23, 2000**

(57) **CLAIM**

The ornamental design for a lawn mower, as shown and described.

(30) **Foreign Application Priority Data**

Sep. 24, 1999 (GB) 2086894
Nov. 16, 1999 (GB) 2088128
Nov. 16, 1999 (GB) 2088129

DESCRIPTION

(51) **LOC (7) Cl.** **15-03**

FIG. 1 is a perspective front view of a lawn mower of the present design;

(52) **U.S. Cl.** **D15/14**

FIG. 2 is a front view of the lawn mower;

(58) **Field of Search** D15/14, 17, 18;
56/11.9, 17.5, 13.4, 12.8, 16.7, 202, 255,
294, 295

FIG. 3 is a top view of the lawn mower;

FIG. 4 is a right side view of the lawn mower;

FIG. 5 is a left side view of the lawn mower; and,

FIG. 6 is a rear view of the lawn mower.

(56) **References Cited**

U.S. PATENT DOCUMENTS

D381,665 S * 7/1997 Hinklin et al. D15/14

1 Claim, 6 Drawing Sheets

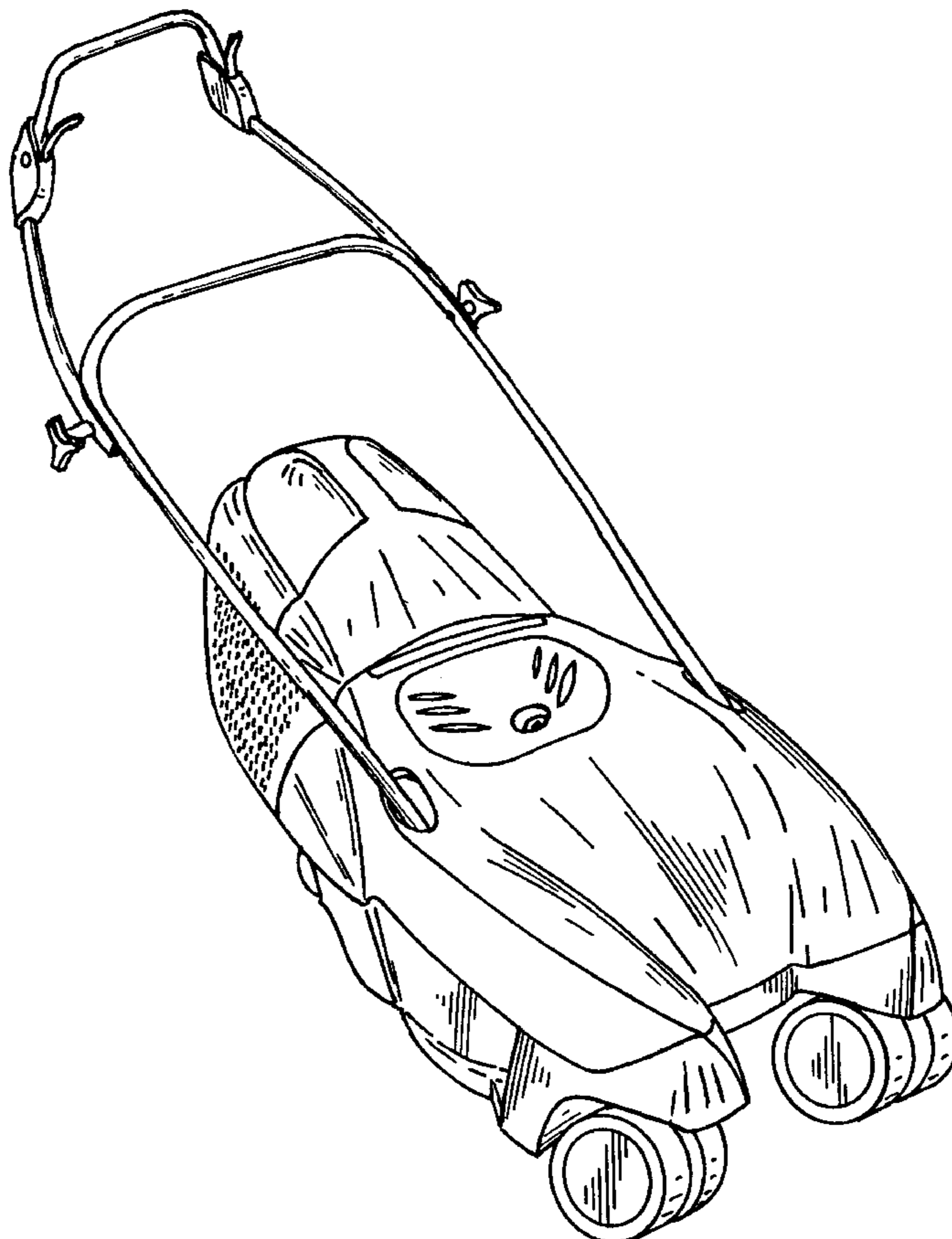

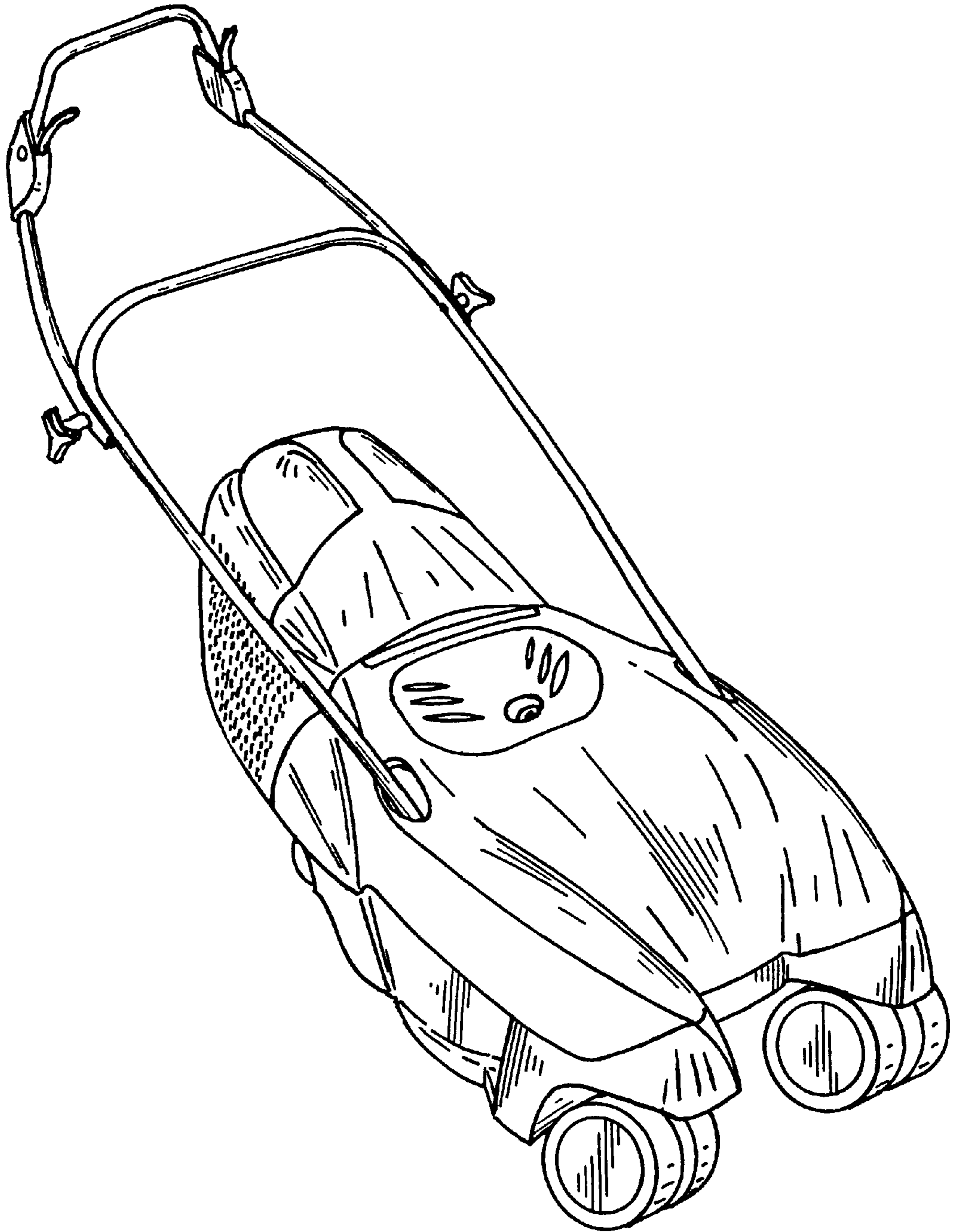
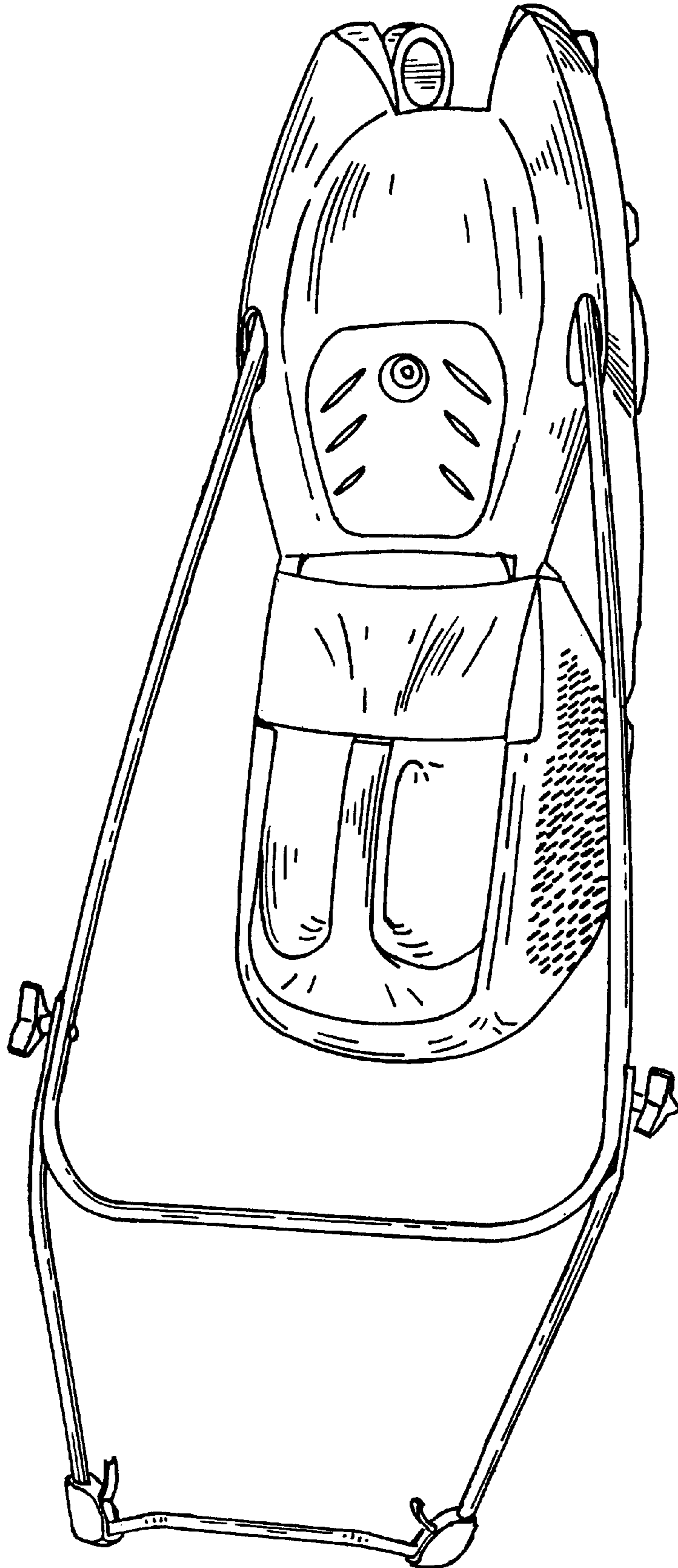

FIG. 1

FIG. 2



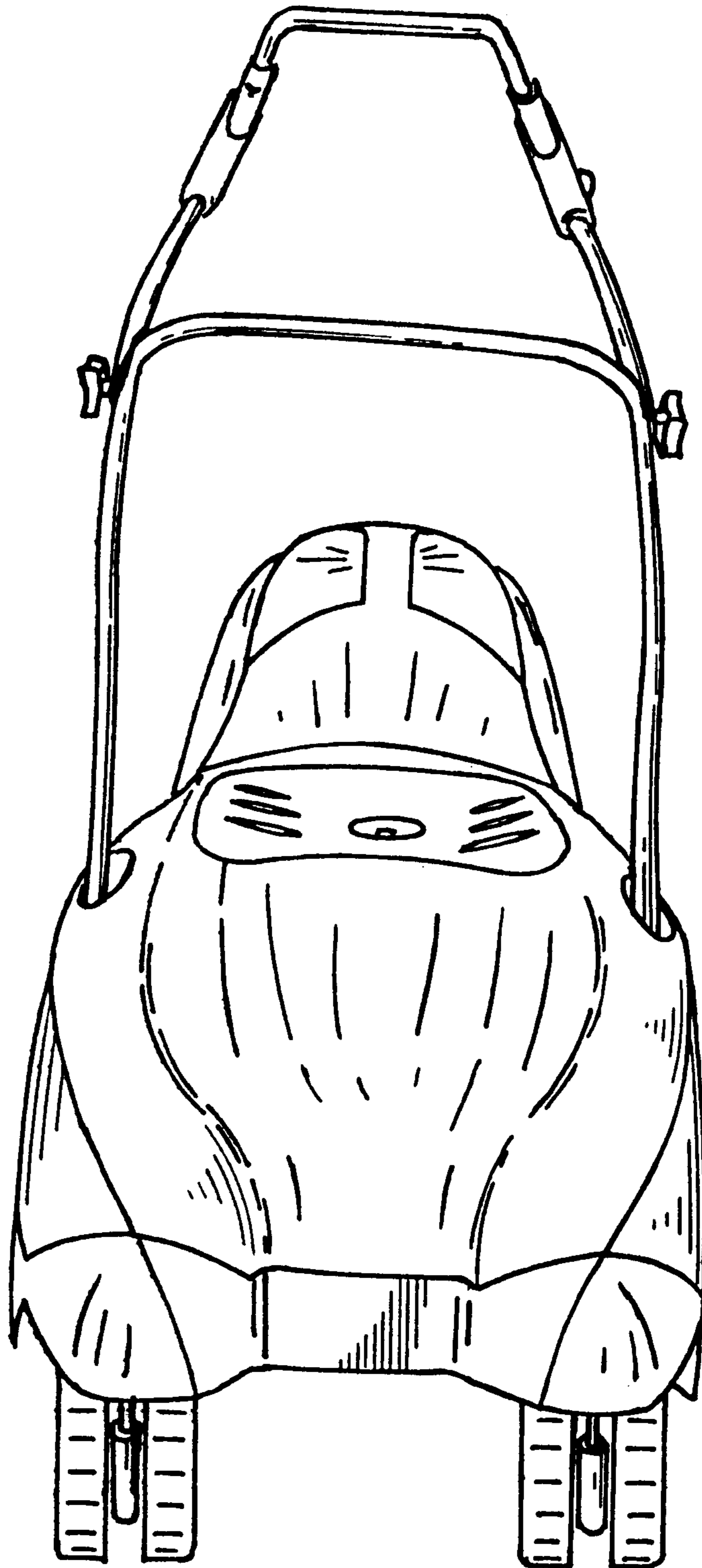

FIG. 3

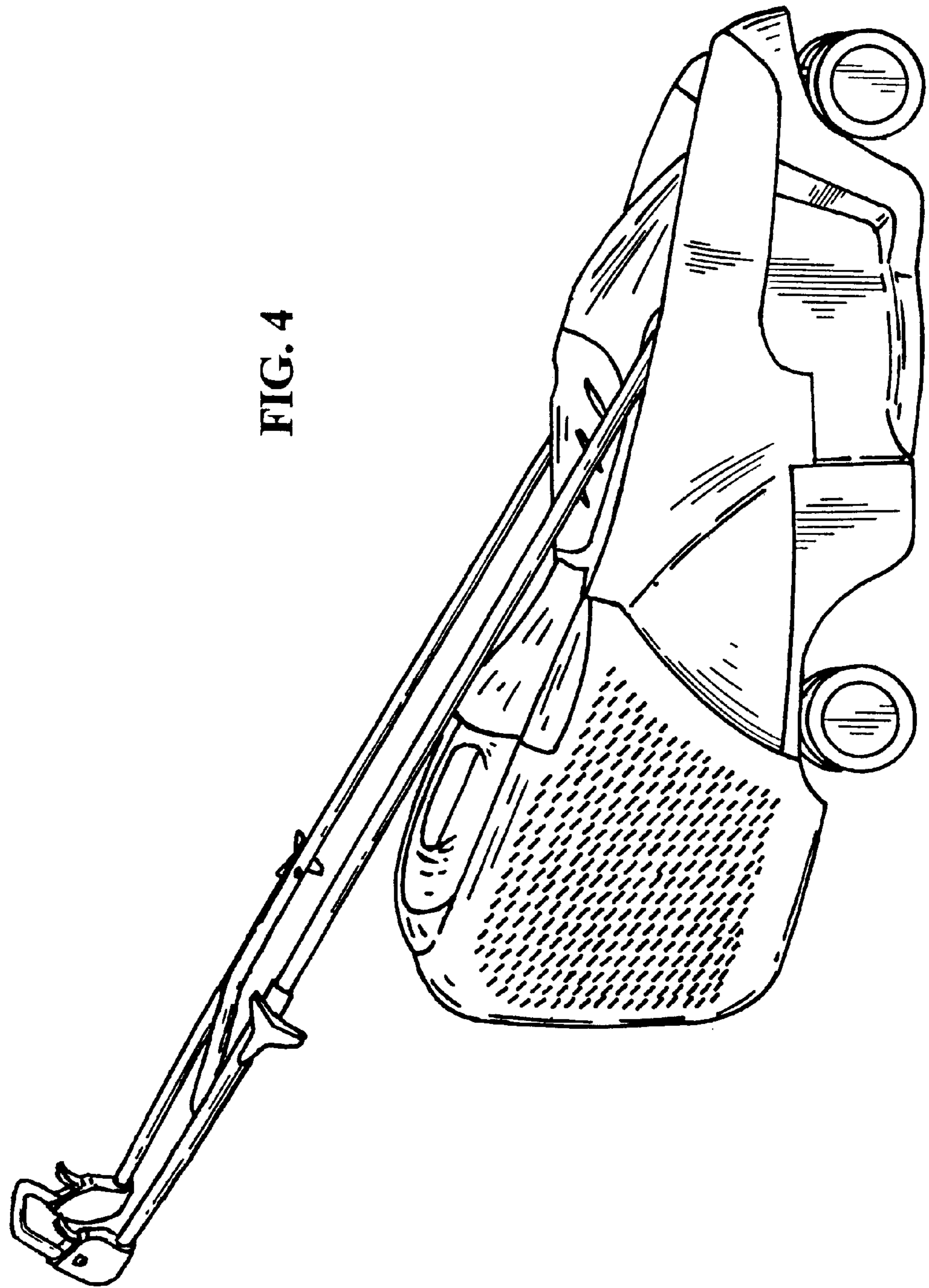
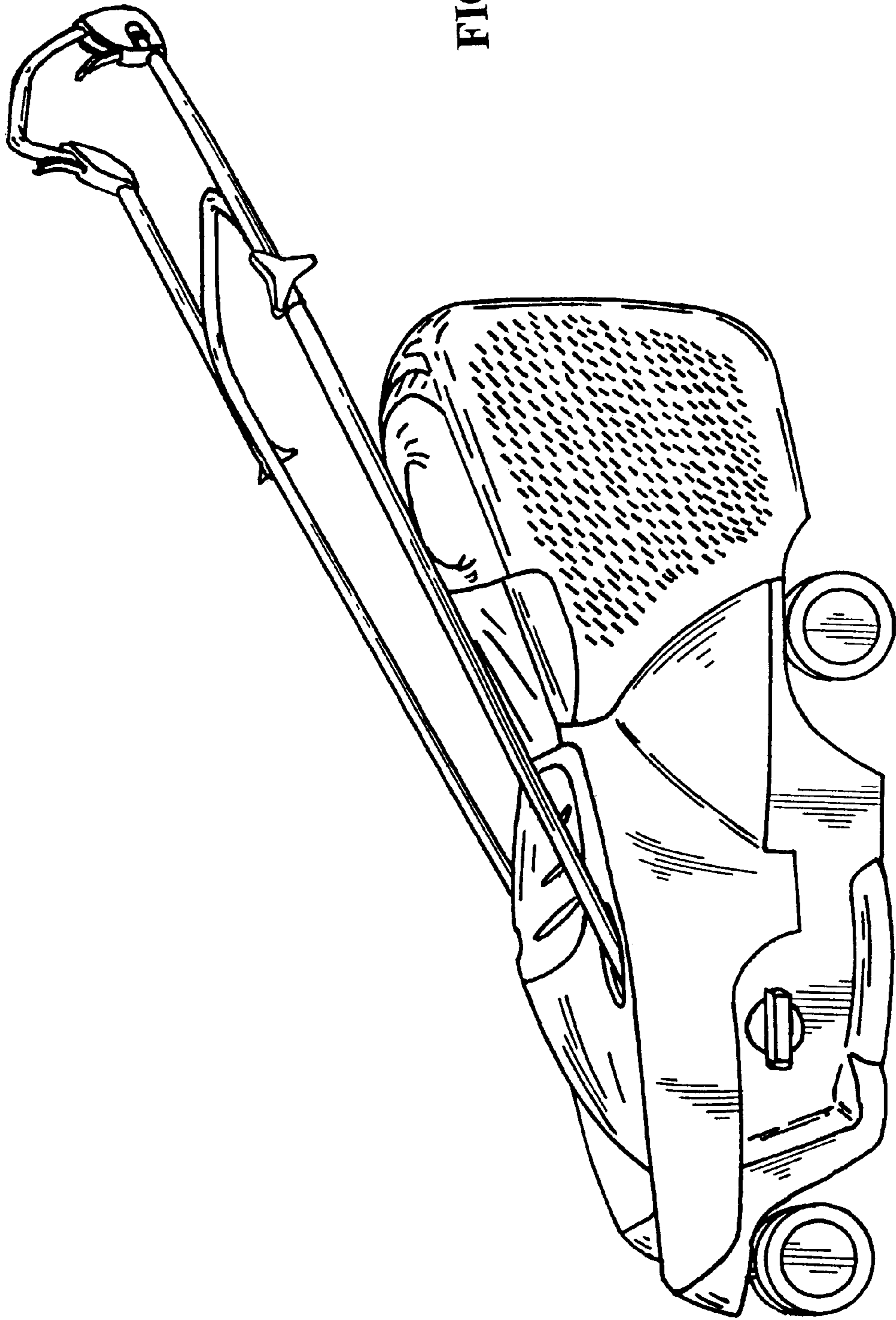

FIG. 4

FIG. 5



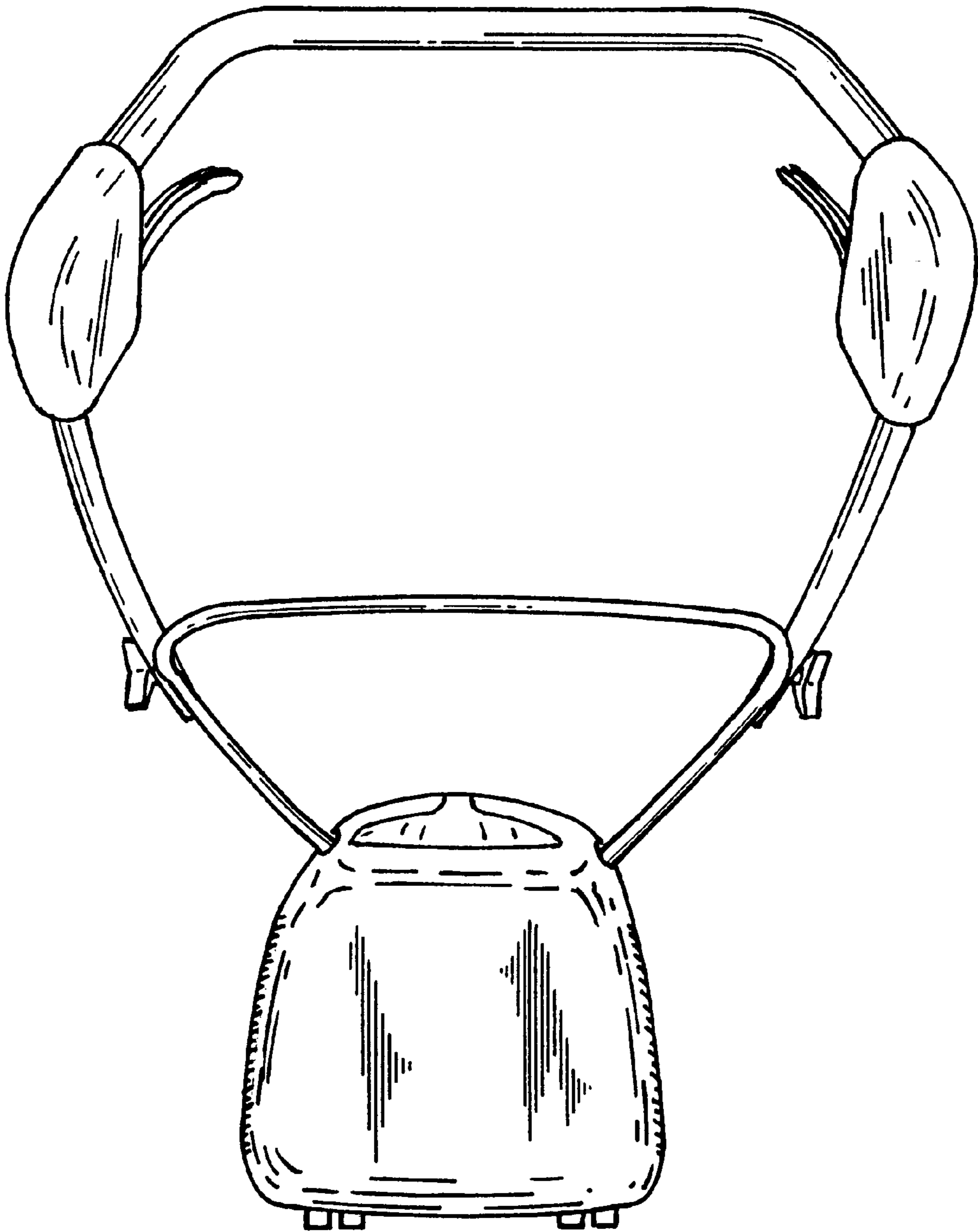

FIG. 6