

US00D461826S

(12) **United States Design Patent**  
**Starkey, Sr.**

(10) **Patent No.:** **US D461,826 S**

(45) **Date of Patent:** **\*\* Aug. 20, 2002**

(54) **COVER FOR PREVENTING  
UNAUTHORIZED ACCESS TO A  
GOVERNOR ON AN INTERNAL  
COMBUSTION ENGINE**

*Primary Examiner*—Antoine Duval Davis  
(74) *Attorney, Agent, or Firm*—Dougherty & Clements,  
LLP

(57) **CLAIM**

(76) **Inventor:** **John R. Starkey, Sr.**, 7974 Henry  
Harris Rd., Fort Mill, SC (US) 29715

The ornamental design for a ornamental design for a cover  
for preventing unauthorized access to a governor on an  
internal combustion engine, as shown and described.

(\*\*) **Term:** **14 Years**

**DESCRIPTION**

(21) **Appl. No.:** **29/148,568**

FIG. 1 is a perspective view of the invented governor access  
preventing cover, showing the new design;

(22) **Filed:** **Sep. 21, 2001**

FIG. 2 is a layout of the invented cover for a governor prior  
to forming it by stamping and bending into its final shape as  
shown in FIG. 1;

(51) **LOC (7) Cl.** ..... **15-01**

(52) **U.S. Cl.** ..... **D15/5; D10/103**

(58) **Field of Search** ..... D10/103; D15/5;  
73/865.1; 137/282; 220/324; 359/808, 810

FIG. 3 is a top view of the governor cover of FIG. 1 after  
forming:

(56) **References Cited**

FIG. 4 is a left side view of the device of FIG. 1; and

FIG. 5 is a front view of the device of FIG. 1.

**U.S. PATENT DOCUMENTS**

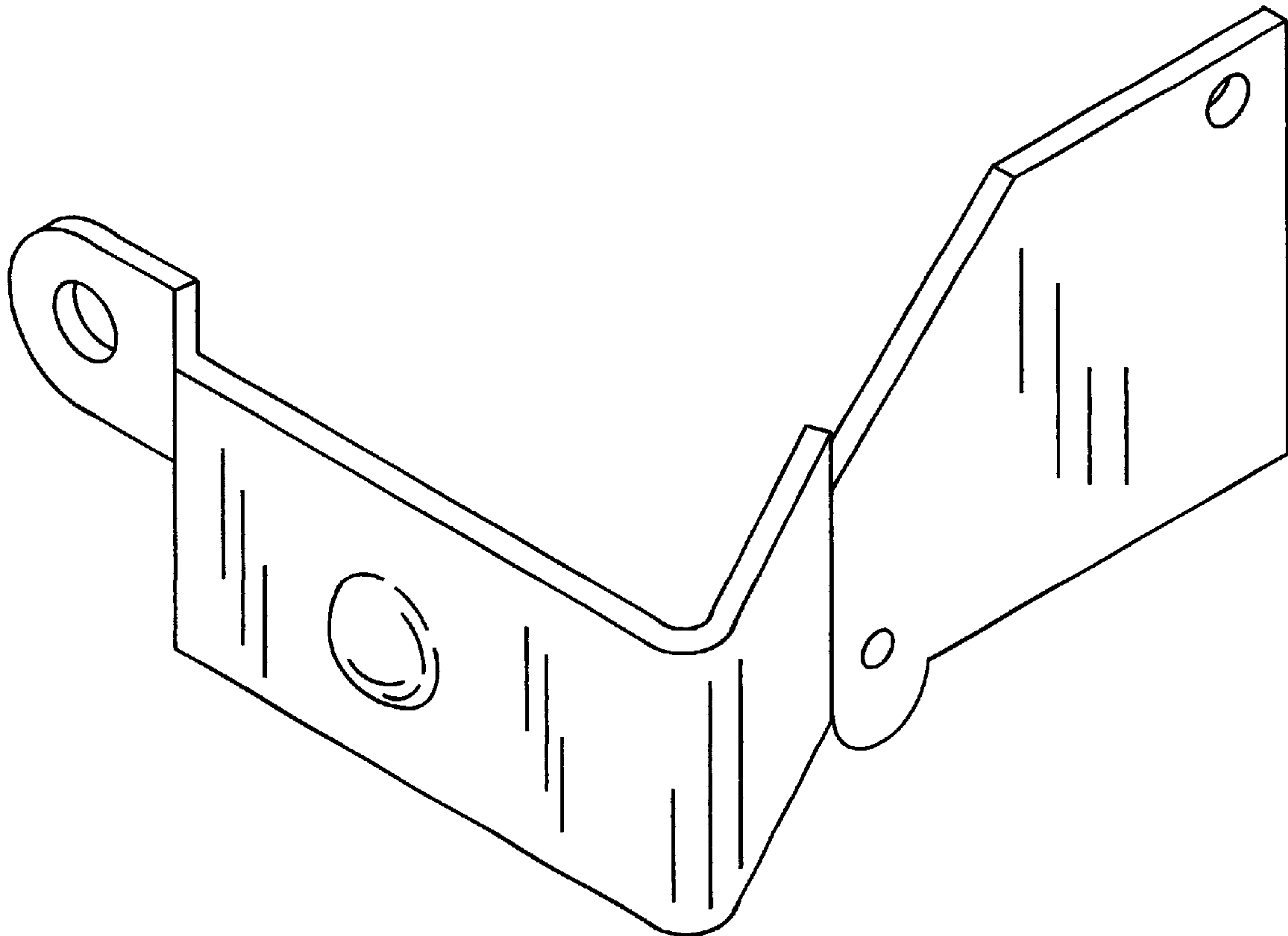
FIG. 6 is a right side view of the device of FIG. 1; and,

FIG. 7 is a bottom view of the device of FIG. 1.

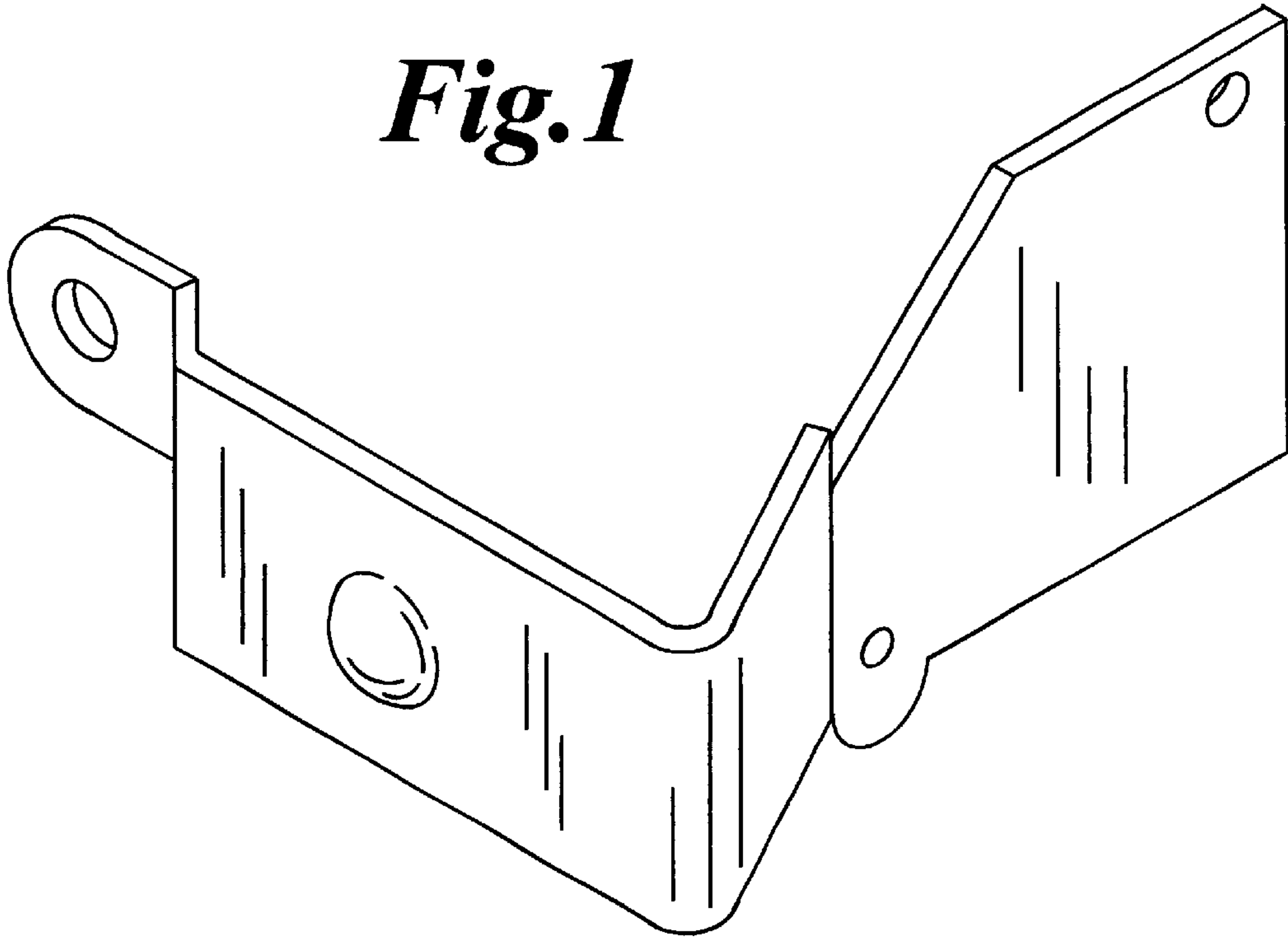
D394,617 S \* 5/1998 Kerlin et al. .... D15/5 X

\* cited by examiner

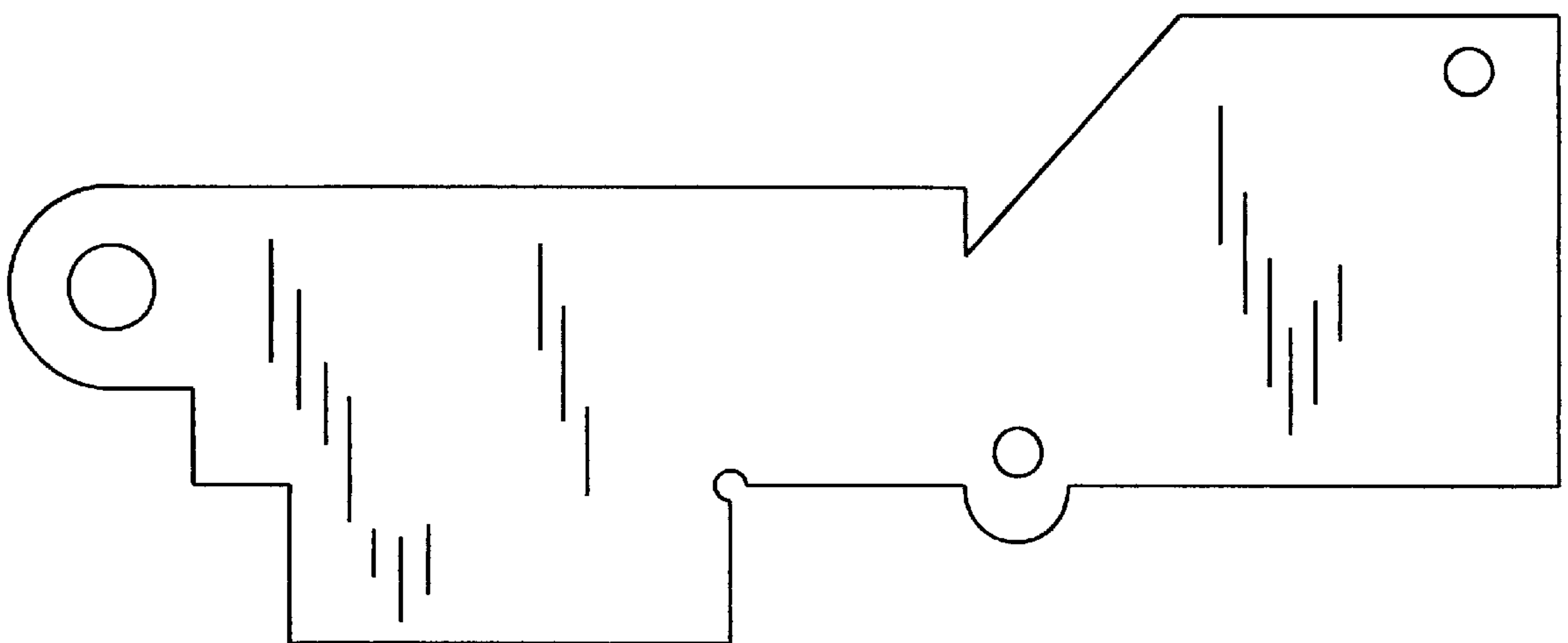
**1 Claim, 2 Drawing Sheets**

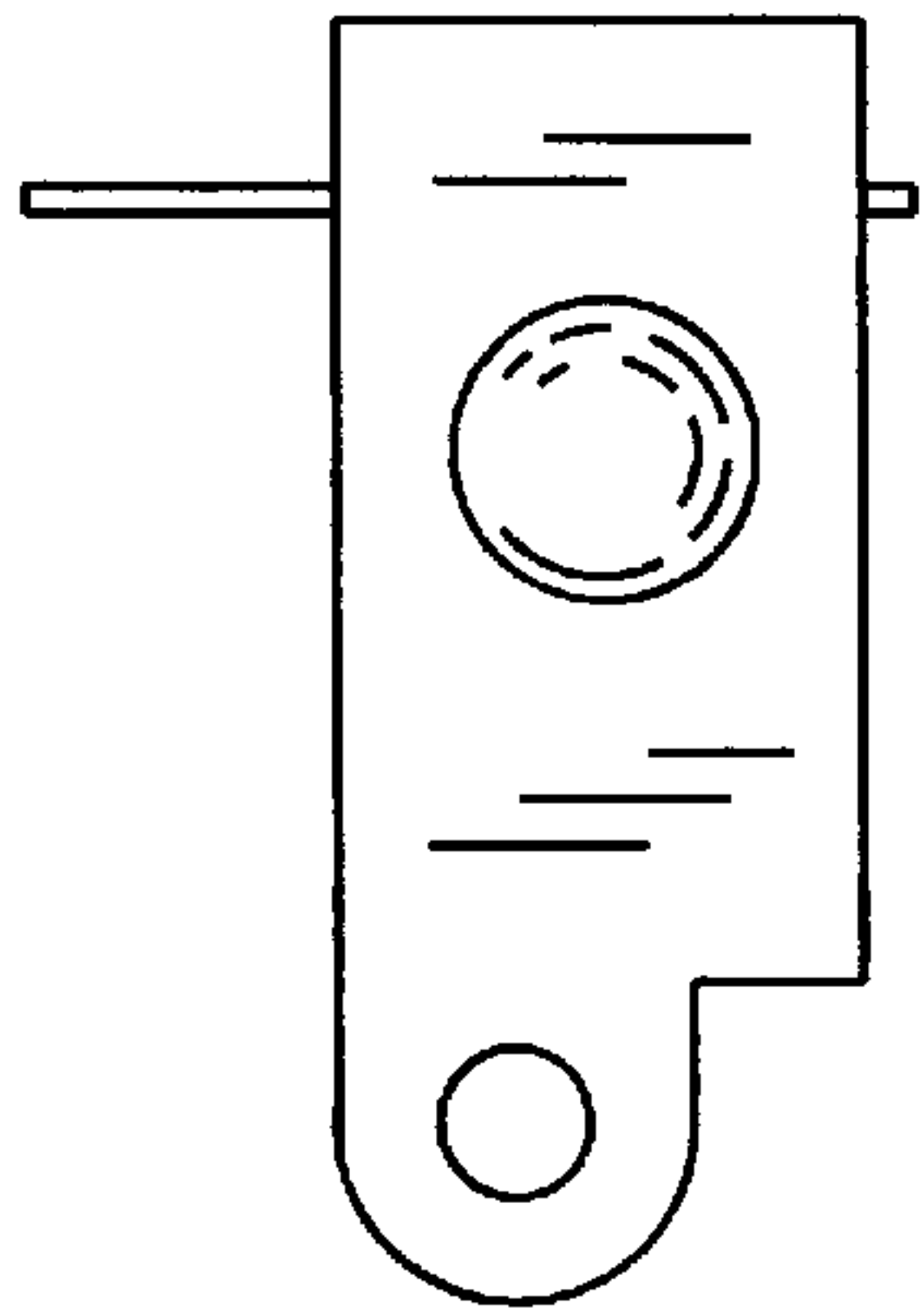


*Fig.1*

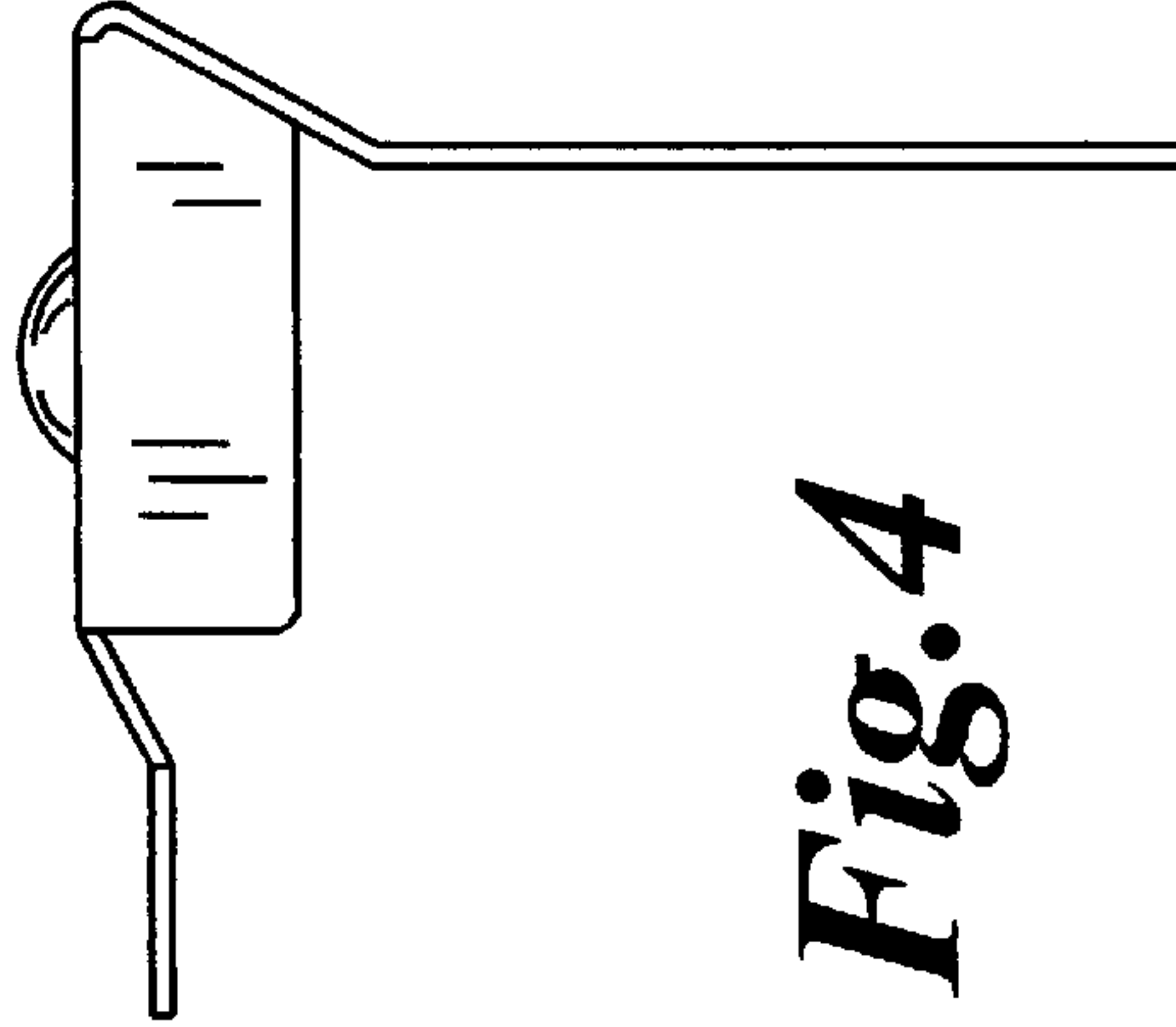


*Fig.2*

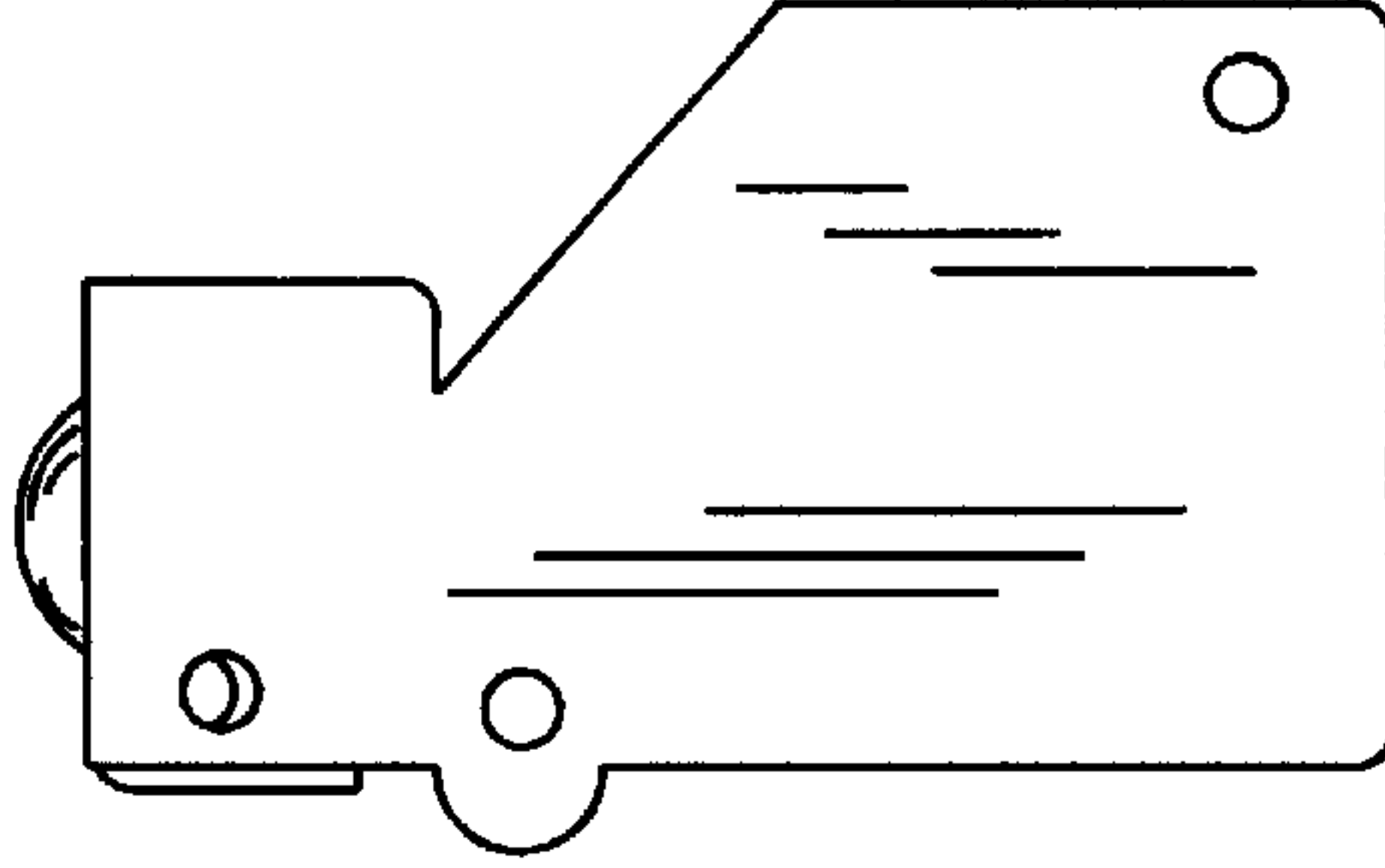




*Fig. 3*

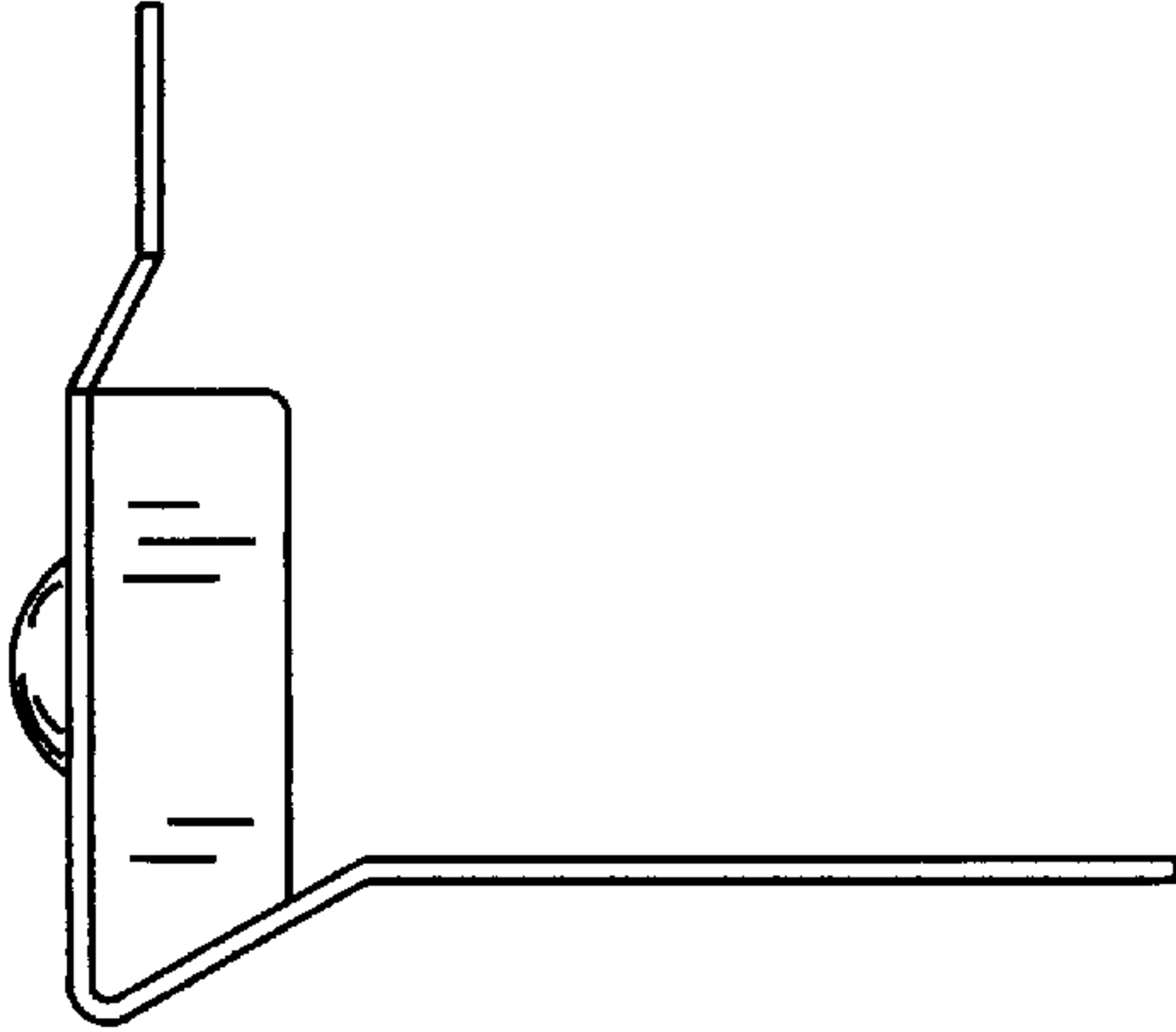


*Fig. 4*



*Fig. 5*

*Fig. 6*



*Fig. 7*

