



US00D461740S

(12) **United States Design Patent**
Lai

(10) **Patent No.:** **US D461,740 S**

(45) **Date of Patent:** **** Aug. 20, 2002**

(54) **JEWELRY SETTING**

(75) Inventor: **Danny S. Lai**, New York, NY (US)

(73) Assignee: **Gramercy Jewelry Manufacturing Corp.**, New York, NY (US)

(**) Term: **14 Years**

(21) Appl. No.: **29/135,078**

(22) Filed: **Jan. 5, 2001**

Related U.S. Application Data

(60) Continuation of application No. 29/123,487, filed on May 18, 2000, now Pat. No. Des. 446,154, which is a division of application No. 29/109,485, filed on Aug. 16, 1999, now Pat. No. Des. 434,694.

(51) **LOC (7) Cl.** **11-01**

(52) **U.S. Cl.** **D11/91**

(58) **Field of Search** D11/1, 2, 7, 8, D11/26, 27, 30-34, 36, 40, 48, 79, 89-92, 86, 75; 63/12-15, 3, 4, 26-28, 29.1, 32

(56) **References Cited**

U.S. PATENT DOCUMENTS

554,870 A	2/1896	Hepding	63/27
D33,769 S	12/1900	Hartman	D11/90
D68,640 S	11/1925	Robboins	D11/34
D80,898 S	4/1930	Kaufman	D11/92
2,200,841 A	5/1940	Gaertner	63/27
D152,252 S	1/1949	Gaertner	D11/92
3,014,354 A	12/1961	McCary	63/27
D273,666 S	5/1984	Hayashi	D11/1
D275,660 S	9/1984	Carroll	D11/86
5,072,601 A	* 12/1991	Slowinski	63/28
D377,741 S	2/1997	Garfolo	D11/86
5,671,613 A	9/1997	Hoover et al.	63/27
D391,516 S	3/1998	Kothari	D11/75

D403,611 S	1/1999	Lai	D11/92
D411,134 S	6/1999	Lai	D11/92
6,003,335 A	* 12/1999	Gurevich et al.	63/26
D427,934 S	* 7/2000	Lai	D11/92
D434,694 S	12/2000	Lai	D11/92
D440,177 S	* 4/2001	Gruosi	D11/26
6,293,129 B1	* 9/2001	Gurevich	63/28

* cited by examiner

Primary Examiner—Louis S. Zarfaz

Assistant Examiner—Deanne Levy

(74) *Attorney, Agent, or Firm*—Baker Botts L.L.P.

(57) **CLAIM**

The ornamental design for a jewelry setting, as shown and described.

DESCRIPTION

FIG. 1 is a top view of a first embodiment of a jewelry setting;

FIG. 2 is a perspective view of the jewelry setting of FIG. 1;

FIG. 3 is another perspective view of the jewelry setting of FIG. 1;

FIG. 4 is a side view of the jewelry setting of FIG. 1;

FIG. 5 is a perspective view of the jewelry setting of FIG. 1 in a pendant;

FIG. 6 is a top view of the jewelry setting of FIG. 5;

FIG. 7 is a perspective view of the jewelry setting of FIG. 1 in an earring;

FIG. 8 is a side view of the jewelry setting of FIG. 7;

FIG. 9 is a top view of the jewelry setting in an earring;

FIG. 10 is a side view of the jewelry setting of FIG. 9;

FIG. 11 is a top view of the jewelry setting in a ring; and, FIG. 12 is a top view of the jewelry setting in another ring. The broken lines are provided for illustrative purpose only and form no part of the claimed design.

1 Claim, 3 Drawing Sheets

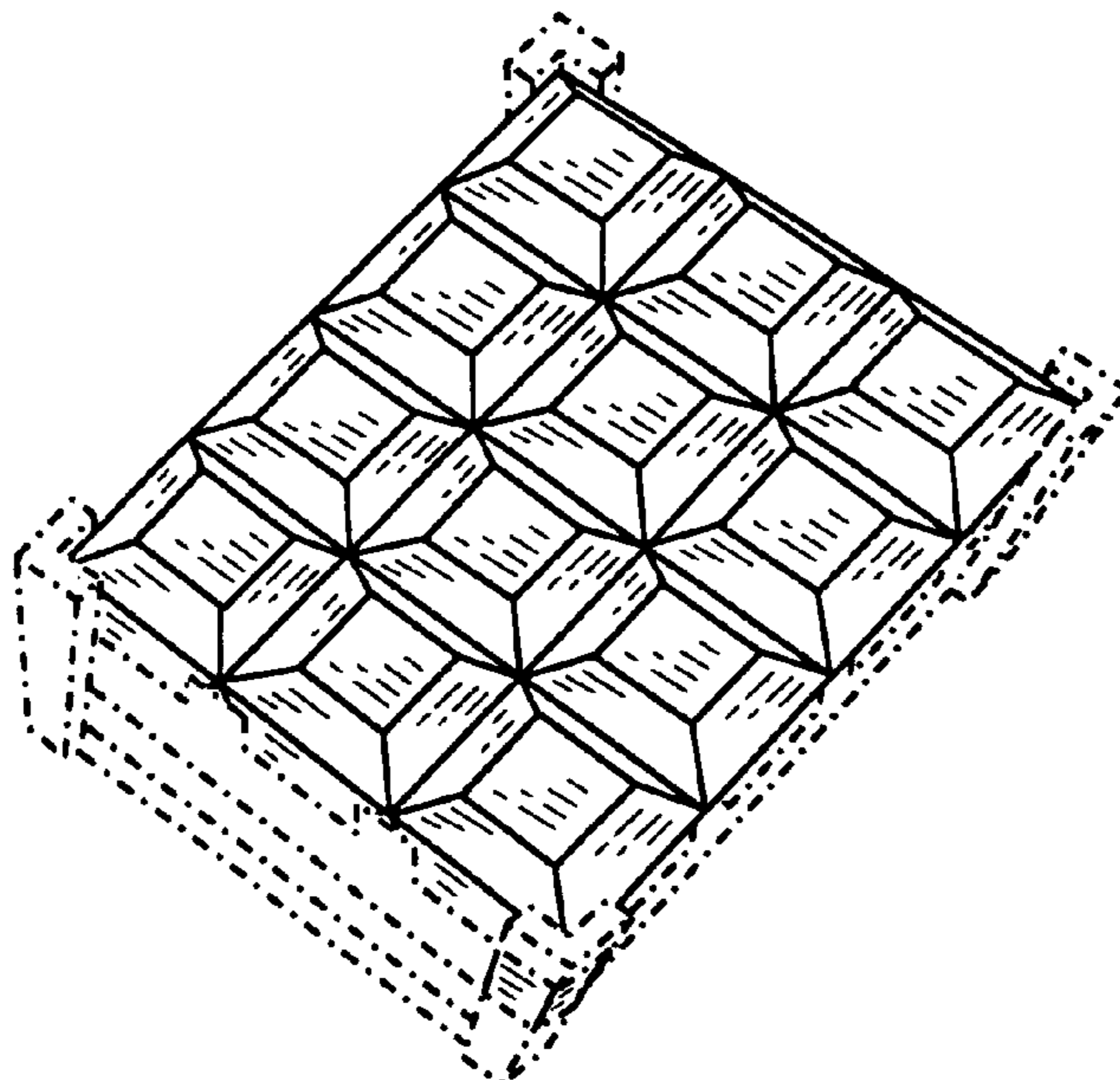

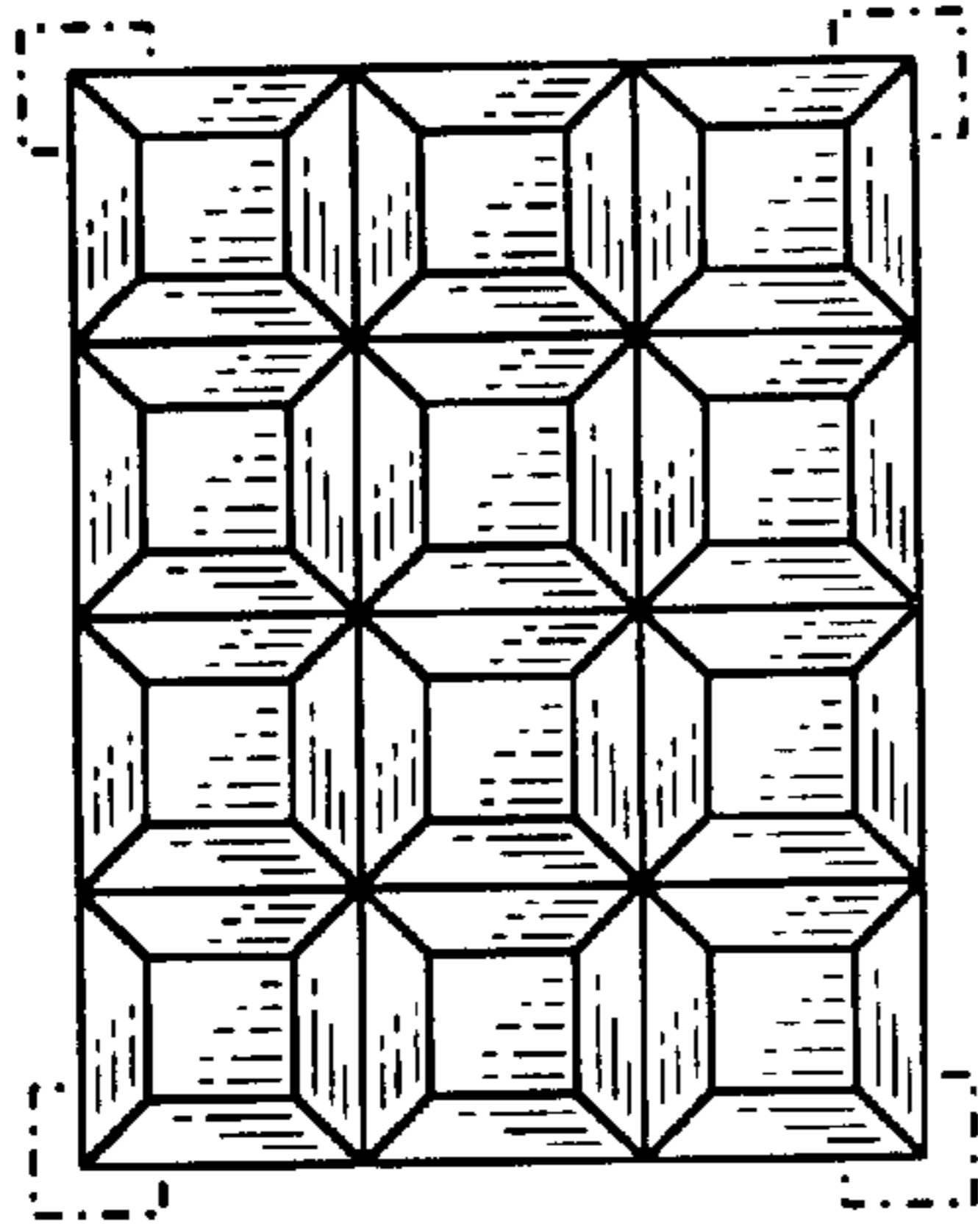

FIG. 1

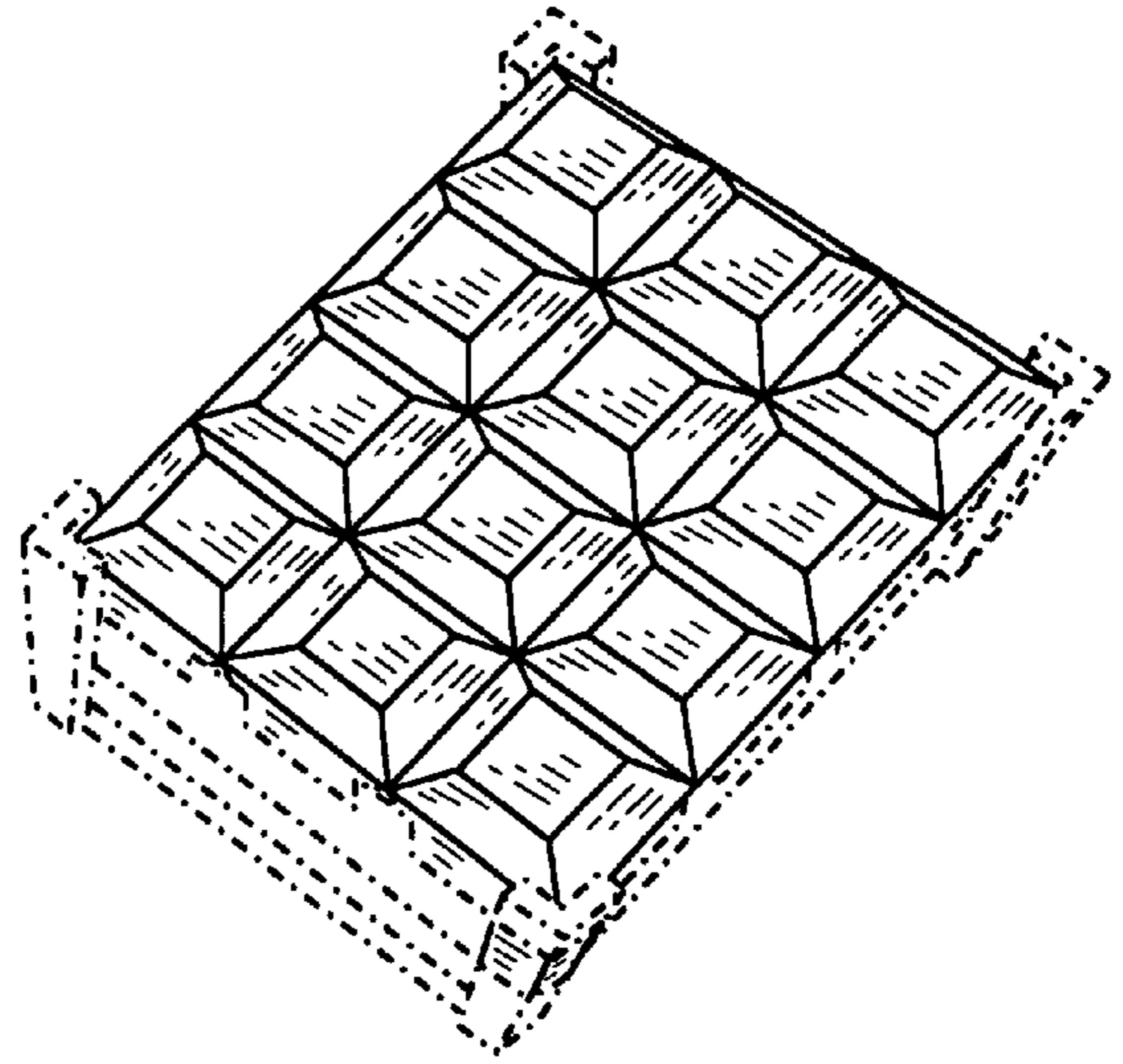

FIG. 2

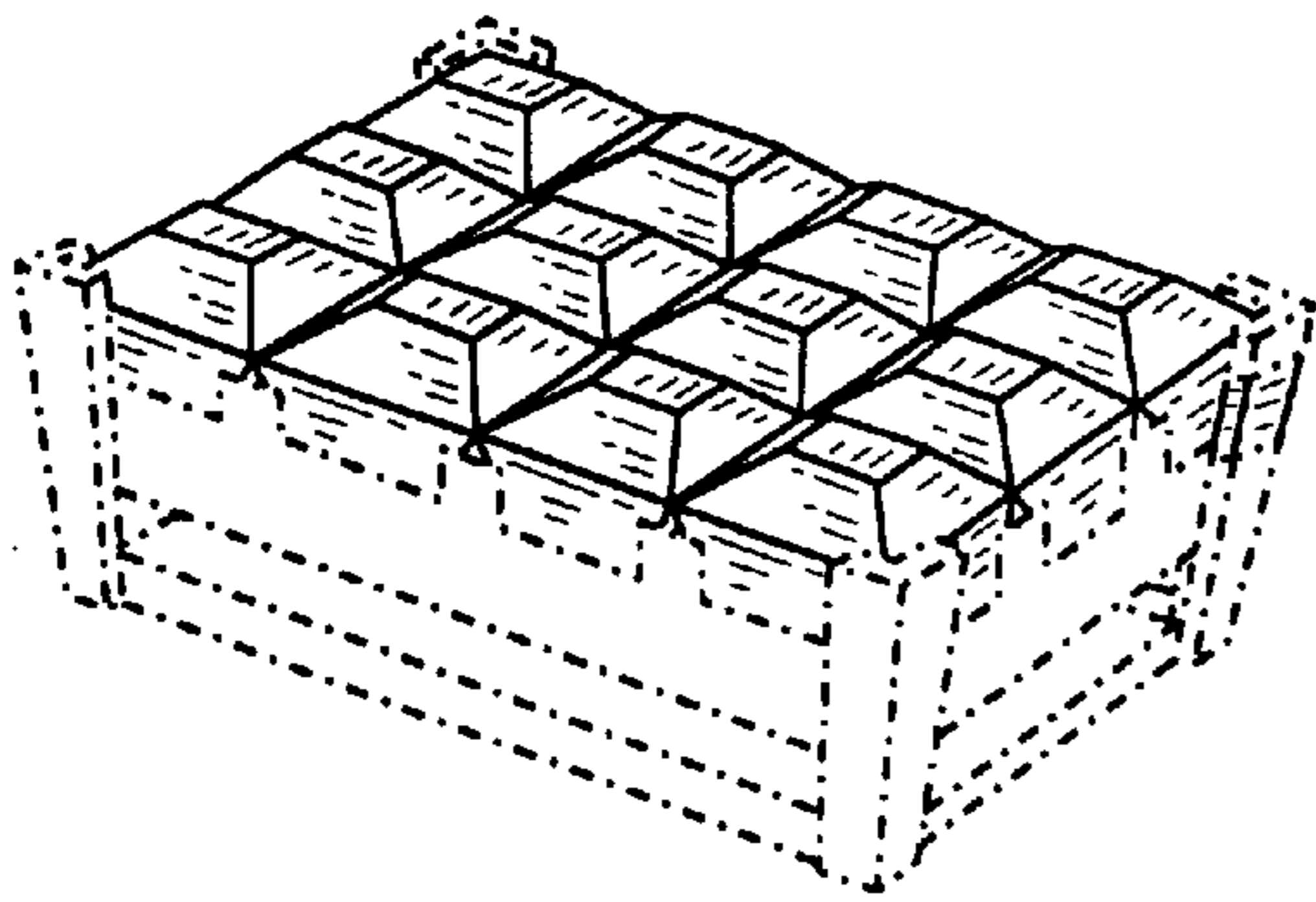

FIG. 3

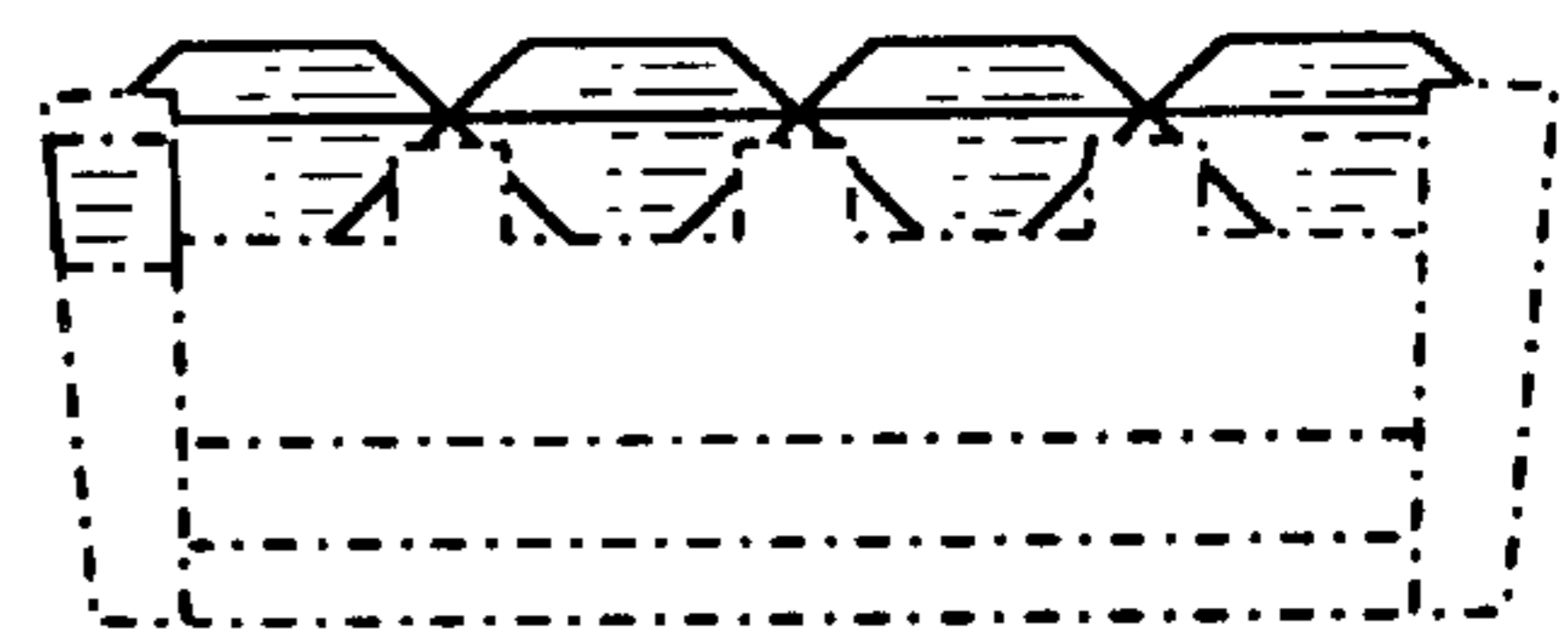

FIG. 4

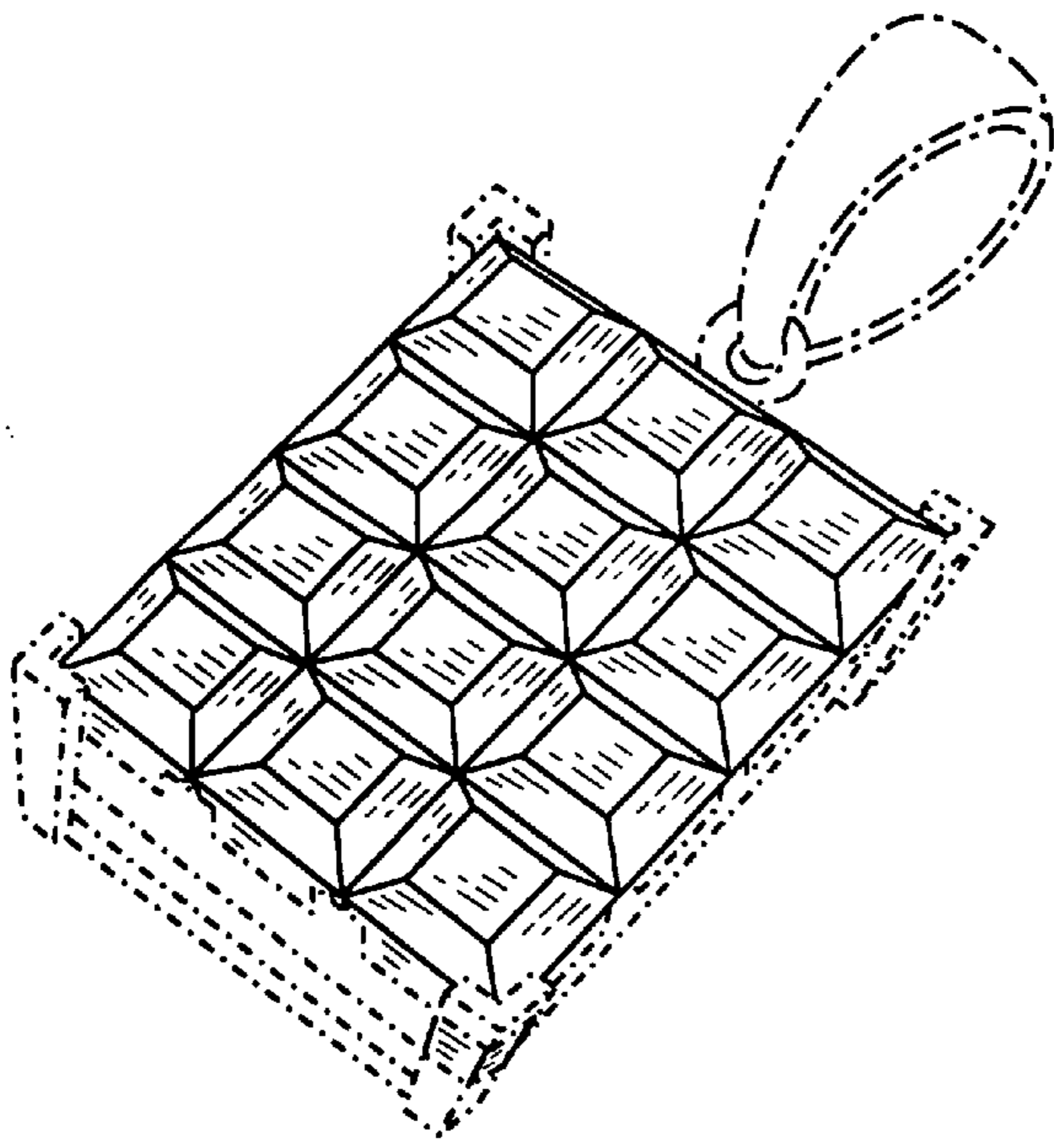

FIG. 5

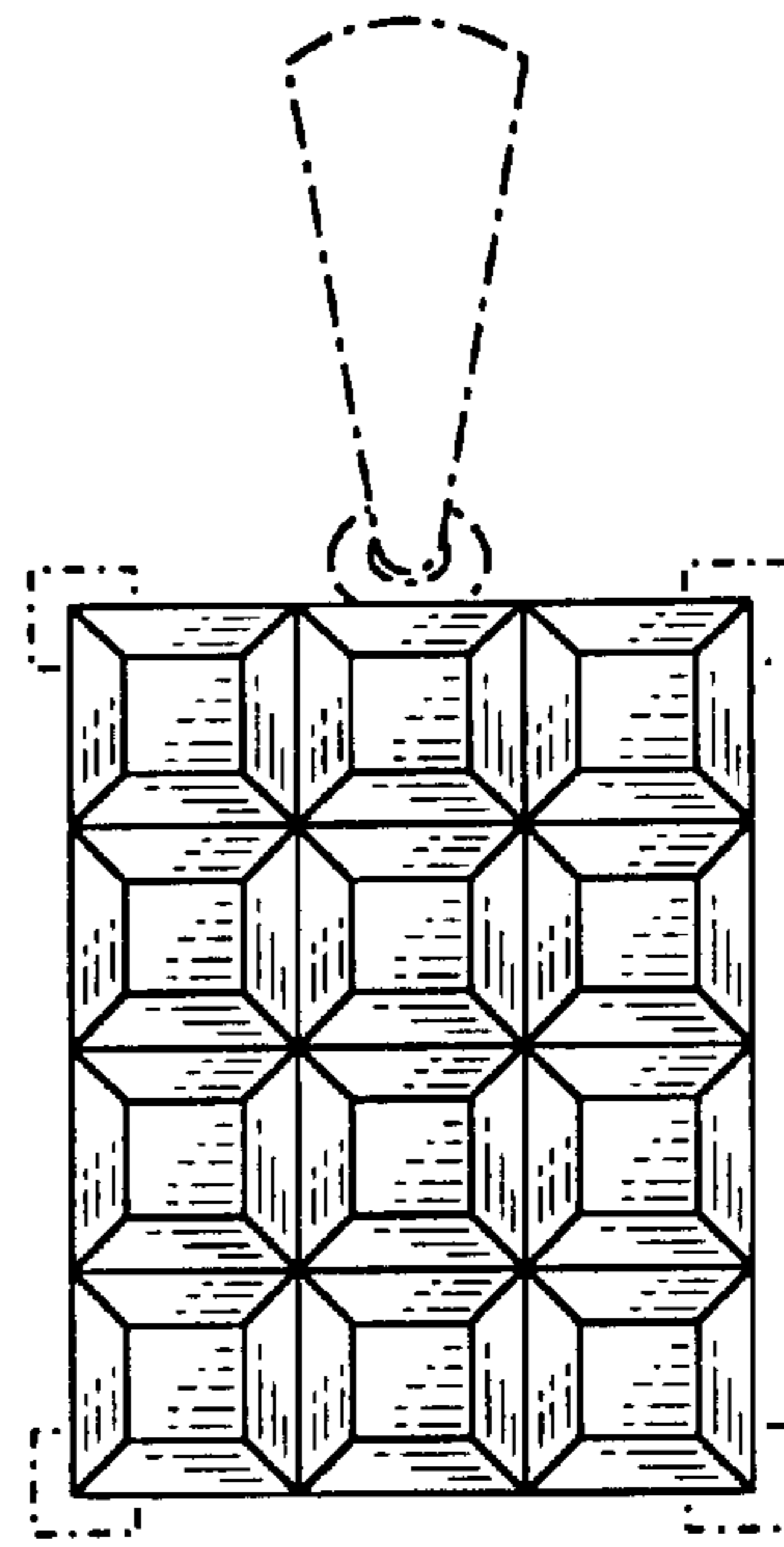

FIG. 6

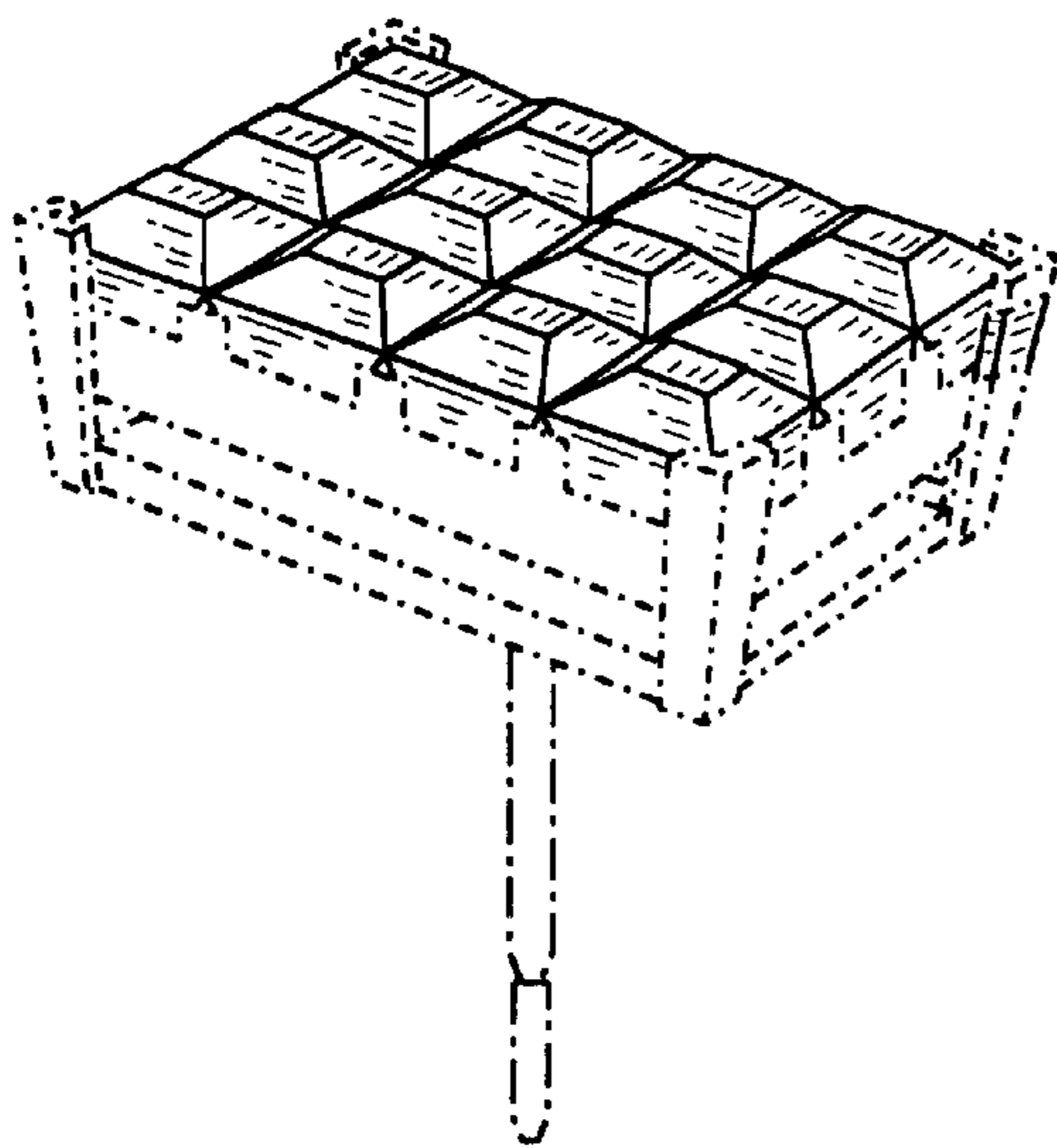

FIG. 7

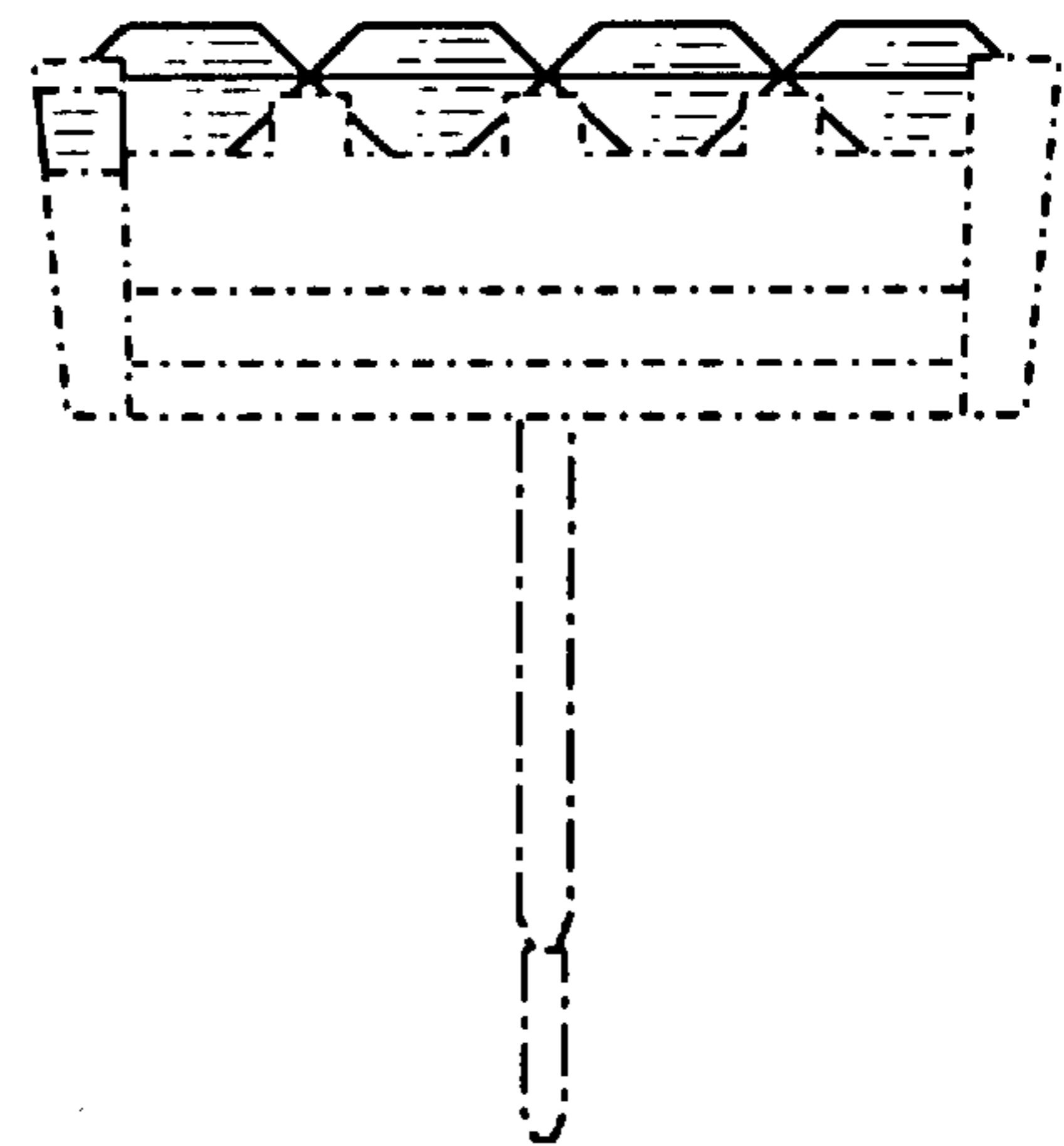

FIG. 8

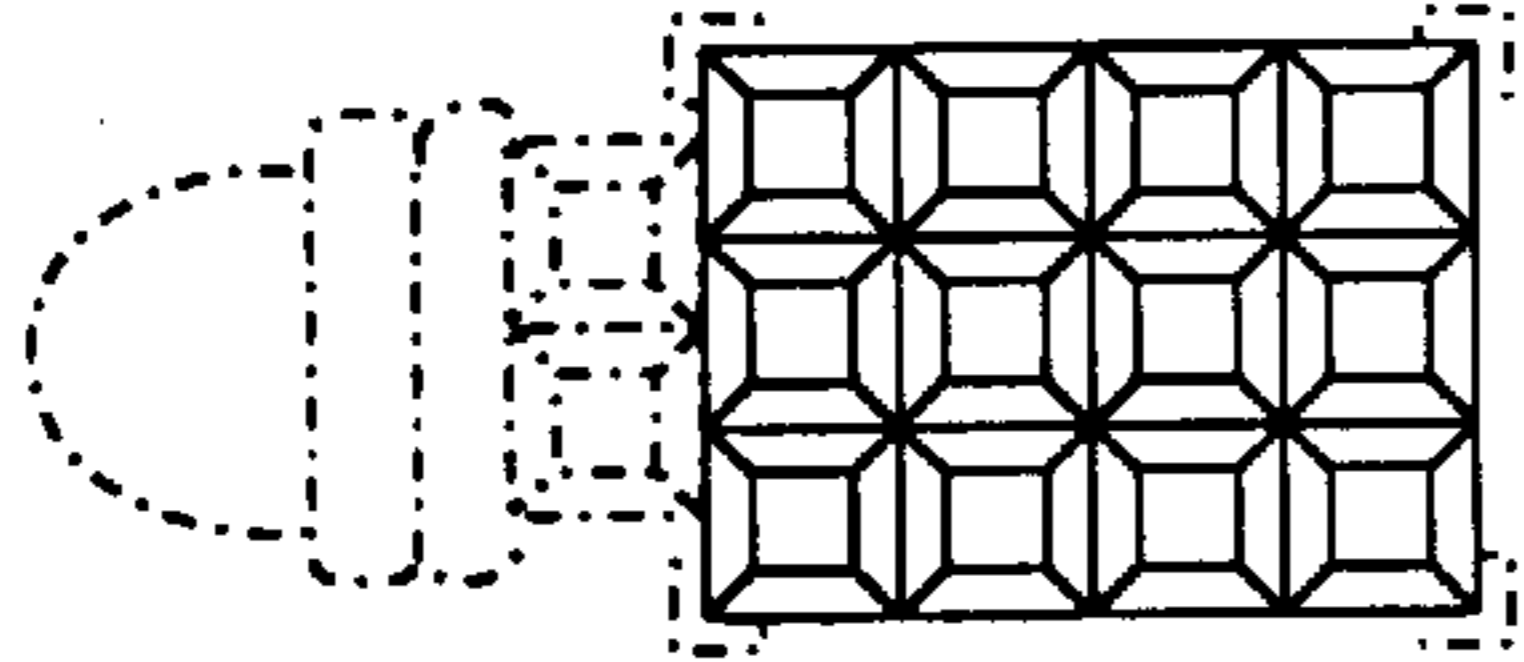

FIG. 9

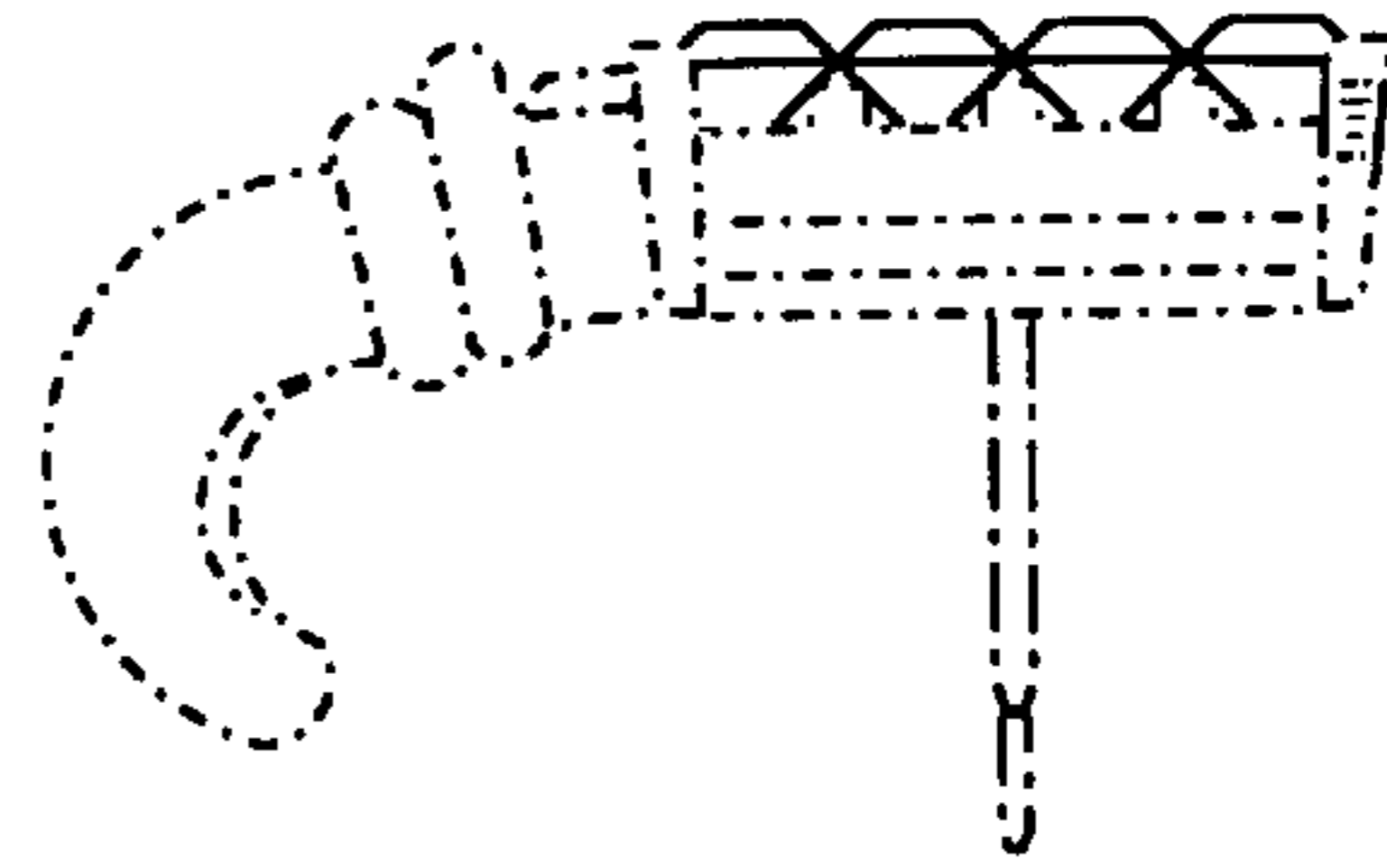

FIG. 10

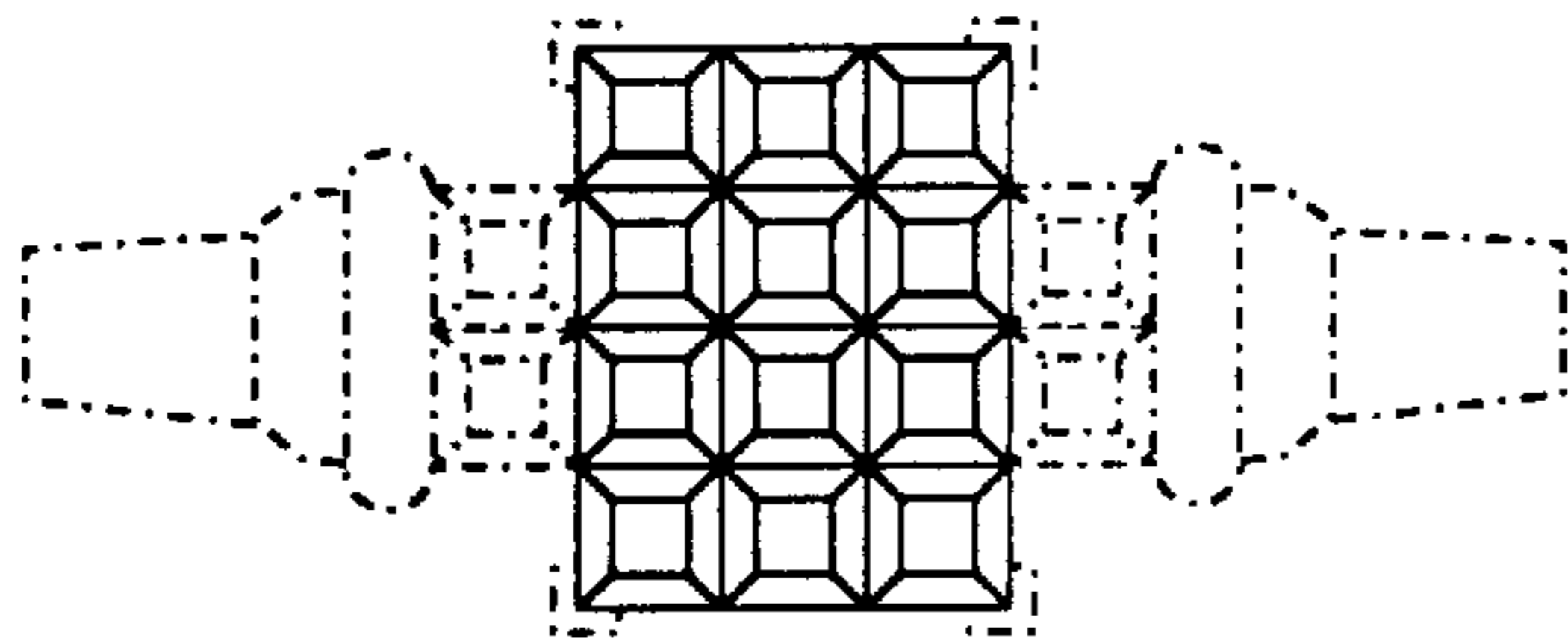

FIG. 11

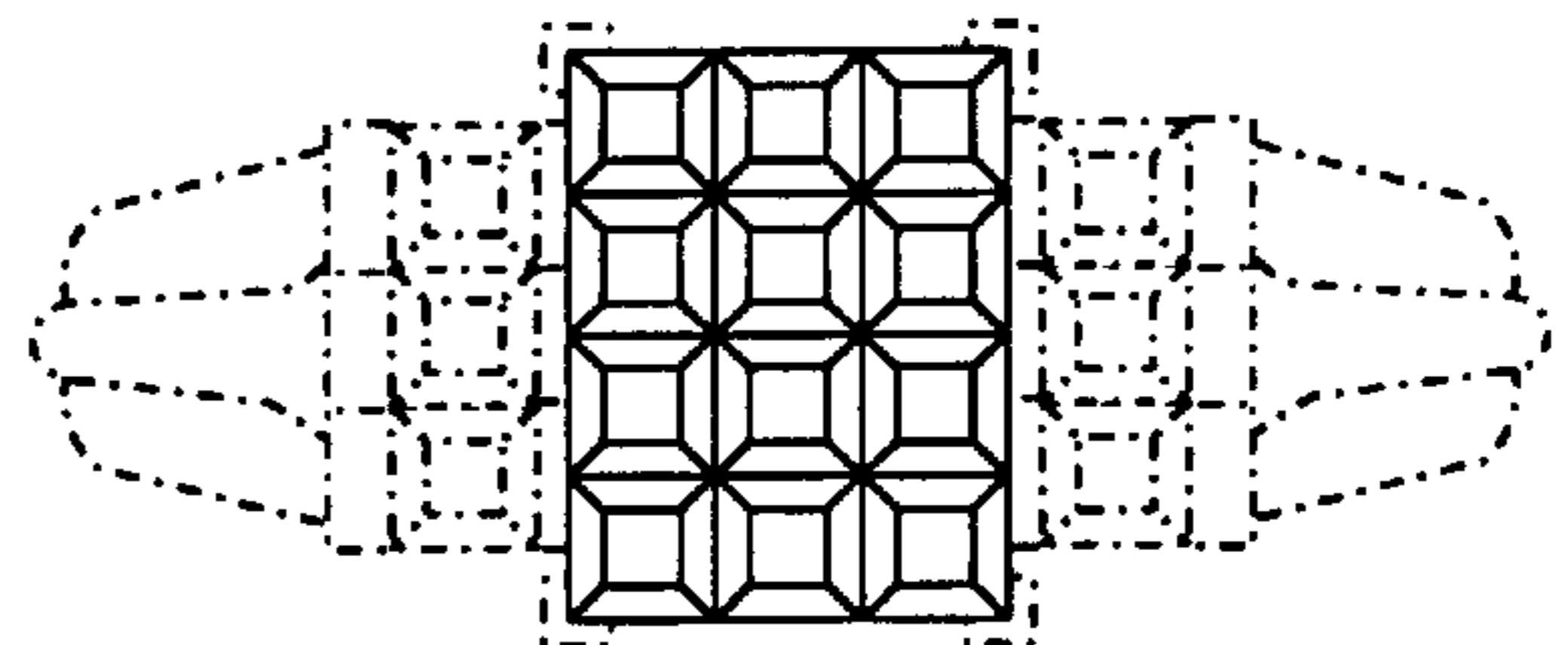

FIG. 12