



US00D461712S

(12) **United States Design Patent**  
**Davis**

(10) **Patent No.:** **US D461,712 S**  
(45) **Date of Patent:** **\*\* Aug. 20, 2002**

(54) **BEVERAGE AND FOOD CARRIER**

**DESCRIPTION**

- (75) Inventor: **Paul S. V. Davis**, Newport Beach, CA (US)
- (73) Assignee: **Easy Carry, LLC**, Costa Mesa, CA (US)
- (\*\*) Term: **14 Years**
- (21) Appl. No.: **29/129,888**
- (22) Filed: **Sep. 22, 2000**
- (51) **LOC (7) Cl.** ..... **09-03**
- (52) **U.S. Cl.** ..... **D9/344**
- (58) **Field of Search** ..... D9/341, 344, 346, D9/347, 415, 433-434, 443, 455-456, 499; 206/216, 223, 485, 494, 493, 503, 514, 518, 557, 527, 560, 784; 220/500, 62, 694, 696, 890; 229/100, 101, 117.09, 117.23, 120.01, 120.02, 121, 121.2, 164-165, 800

(56) **References Cited**

**U.S. PATENT DOCUMENTS**

D110,691	S	*	8/1938	Dudley	
2,728,484	A		12/1955	Farrington	
2,759,629	A		8/1956	Sargent	
2,828,047	A		3/1958	Weiselberg	
3,225,959	A		12/1965	Jamison	
3,276,575	A	*	10/1966	Sanderson	..... 206/52
3,565,323	A		2/1971	Katzenmeyer et al.	
3,744,704	A		7/1973	Struble	
3,868,140	A		2/1975	Gordon	
4,053,099	A		10/1977	Lock	
4,155,502	A		5/1979	Forte	
4,744,613	A		5/1988	Brantingham et al.	

(List continued on next page.)

*Primary Examiner*—James Gandy

*Assistant Examiner*—Daniel Bui

(74) *Attorney, Agent, or Firm*—Knobbe, Martens, Olson & Bear, LLP

(57) **CLAIM**

The ornamental design for a beverage and food carrier, as shown and described.

FIG. 1 is a perspective view of the beverage and food carrier showing my new design the dashed lines shown on upper portion of the beverage and food carrier represent the folding lines.

FIG. 2 is a right side elevational view of the beverage and food carrier, shown in FIG. 1;

FIG. 3 is a perspective view showing the lower portion of the beverage and food carrier of FIG. 1 with the upper removable tray removed for clarity of illustration;

FIG. 4 is a front elevational view of the lower portion of the beverage and food carrier shown in FIG. 3;

FIG. 5 is a left side elevational view of the lower portion of the beverage and food carrier shown in FIG. 3;

FIG. 6 is a right side elevational view of the lower portion of the beverage and food carrier shown in FIG. 3;

FIG. 7 is a top plan view of the lower portion of the beverage and food carrier shown in FIG. 3;

FIG. 8 is a bottom plan view of the lower portion of the beverage and food carrier shown in FIG. 3;

FIG. 9 is a perspective view of the topside of the removable upper tray portion of the beverage and food carrier of FIG. 1;

FIG. 10 is a perspective view of the bottom side of the removable upper tray portion of the beverage and food carrier shown in FIG. 9;

FIG. 11 is an enlarged side elevational view of two of the sides of the upper tray portion of the beverage and food carrier shown in FIG. 9.

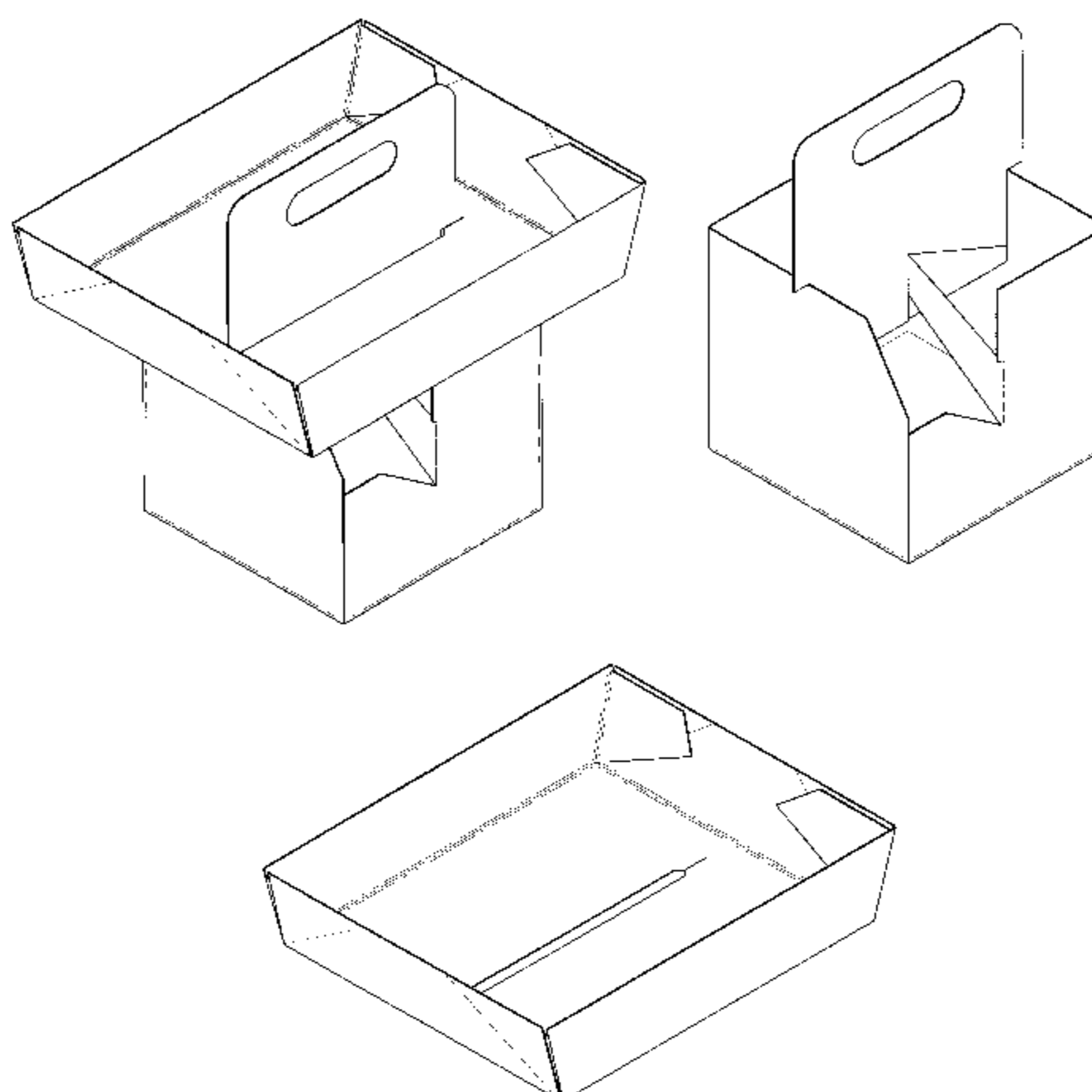
FIG. 12 is an enlarged side elevational view of the other two sides of the upper tray portion of the beverage and food carrier shown in FIG. 9.

FIG. 13 is an enlarged bottom view of the upper tray portion of the beverage and food carrier shown in FIG. 9; and,

FIG. 14 is an enlarged top view of the upper tray portion of the beverage and food carrier shown in FIG. 9.

The topside of the removable upper tray portion of the beverage and food carrier shown in FIGS. 9-14 is shown separately for clarity of illustration only.

**1 Claim, 13 Drawing Sheets**



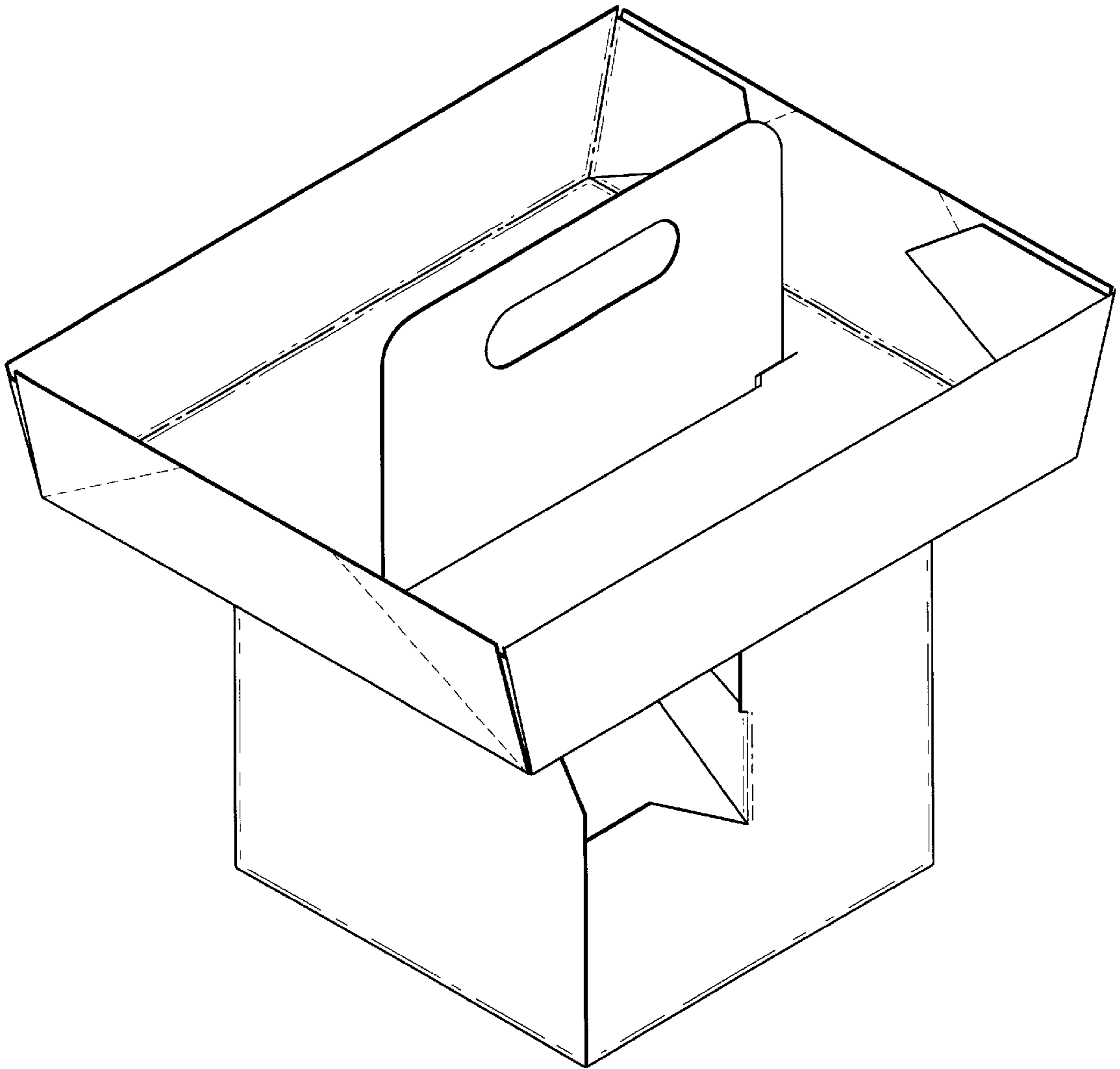
# US D461,712 S

Page 2

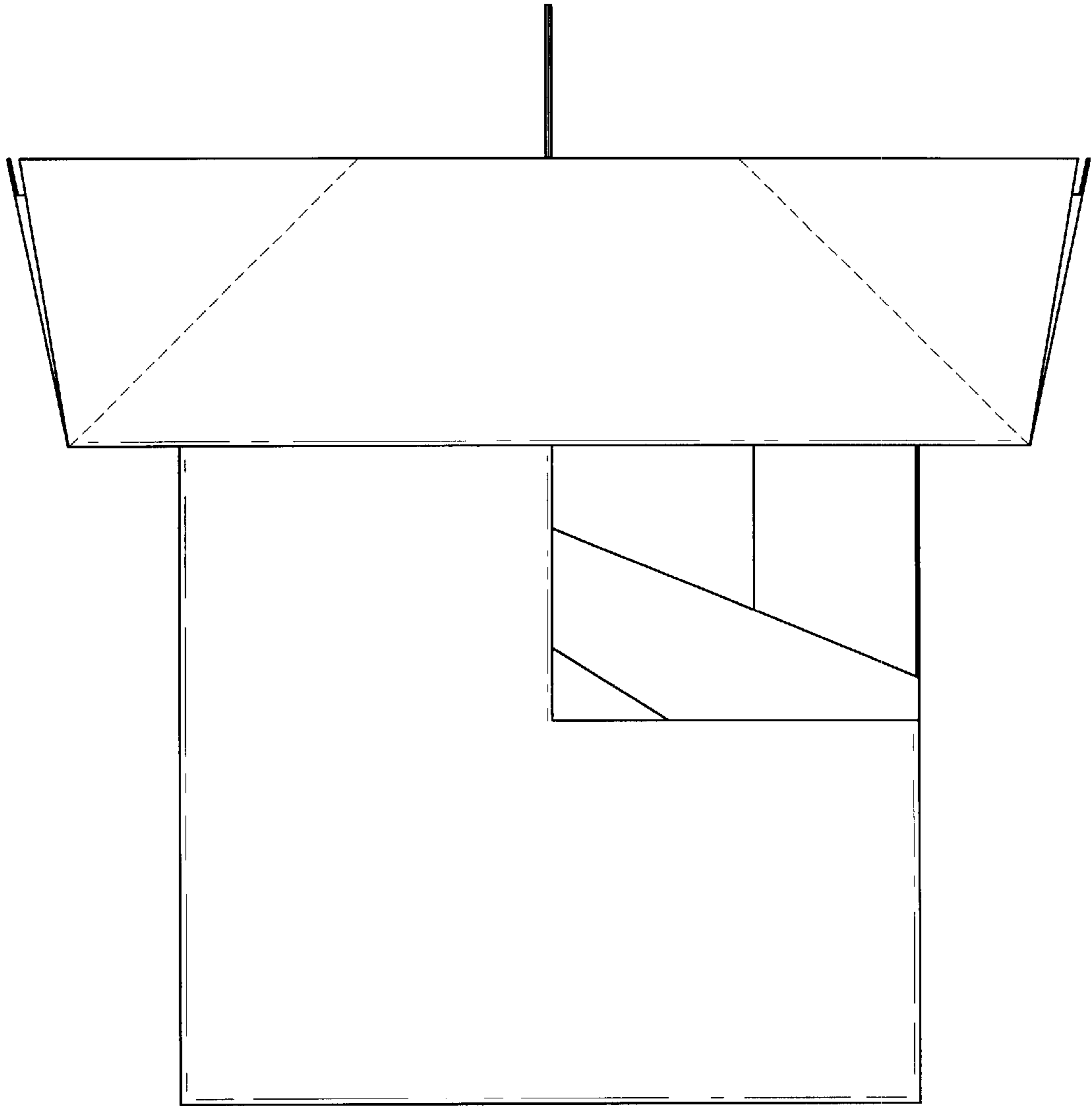
---

U.S. PATENT DOCUMENTS		
5,249,700 A	10/1993	Dumke
5,325,962 A *	7/1994	Ouellette ..... 206/229
D364,560 S *	11/1995	Colvin et al. .... D9/346
D367,409 S	2/1996	Hunter
5,524,814 A	6/1996	Davis
5,609,379 A	3/1997	Harrelson
D386,680 S *	11/1997	Johnson ..... D9/346
5,738,217 A *	4/1998	Hunter ..... 206/549
5,765,684 A	6/1998	Van Dore et al.
5,788,081 A	8/1998	Bates
5,797,486 A	8/1998	Picciolo
5,813,540 A	9/1998	Vollbrecht et al.
5,833,056 A	11/1998	Goldman
5,927,502 A *	7/1999	Hunter ..... 206/549

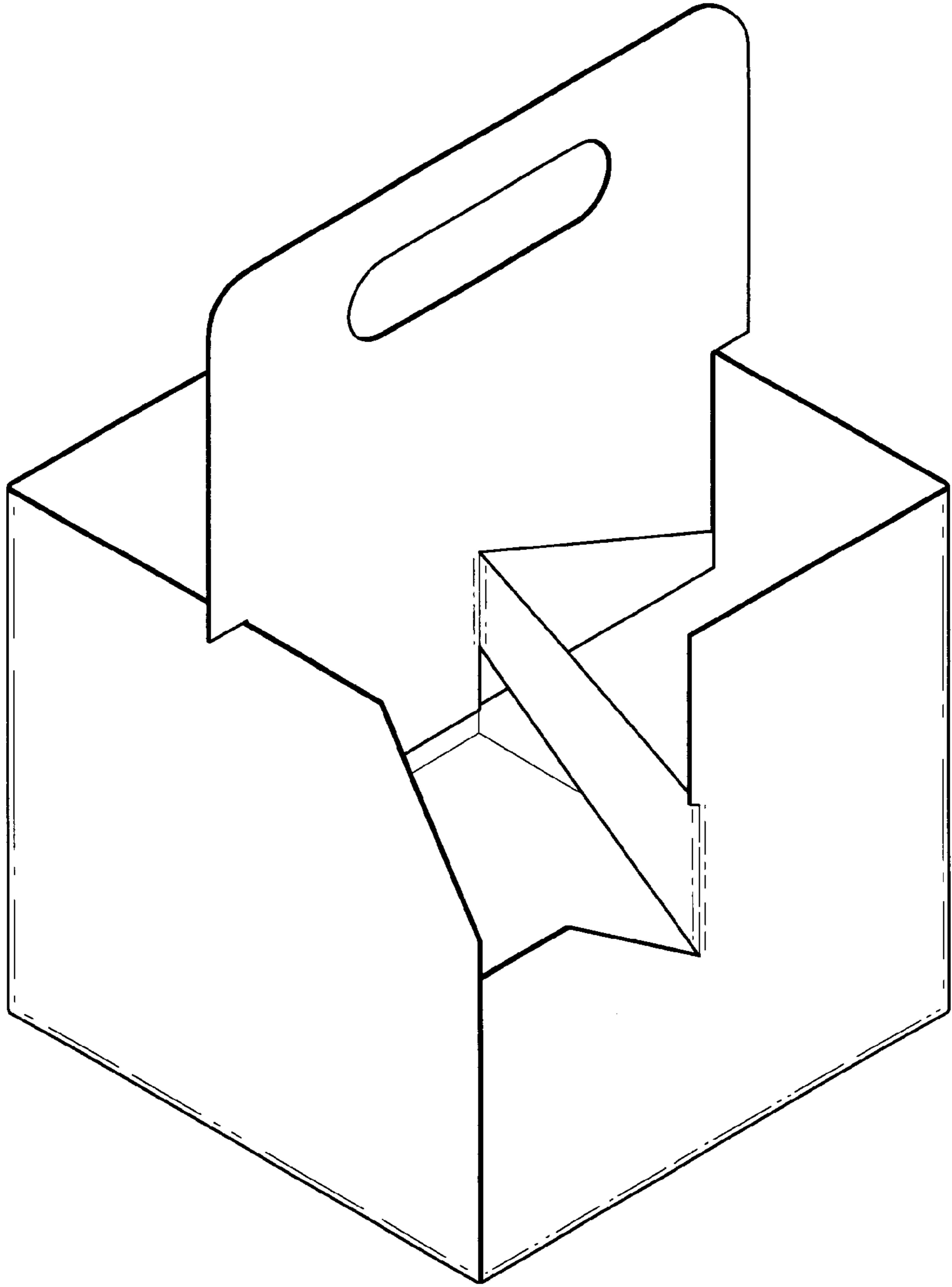
\* cited by examiner



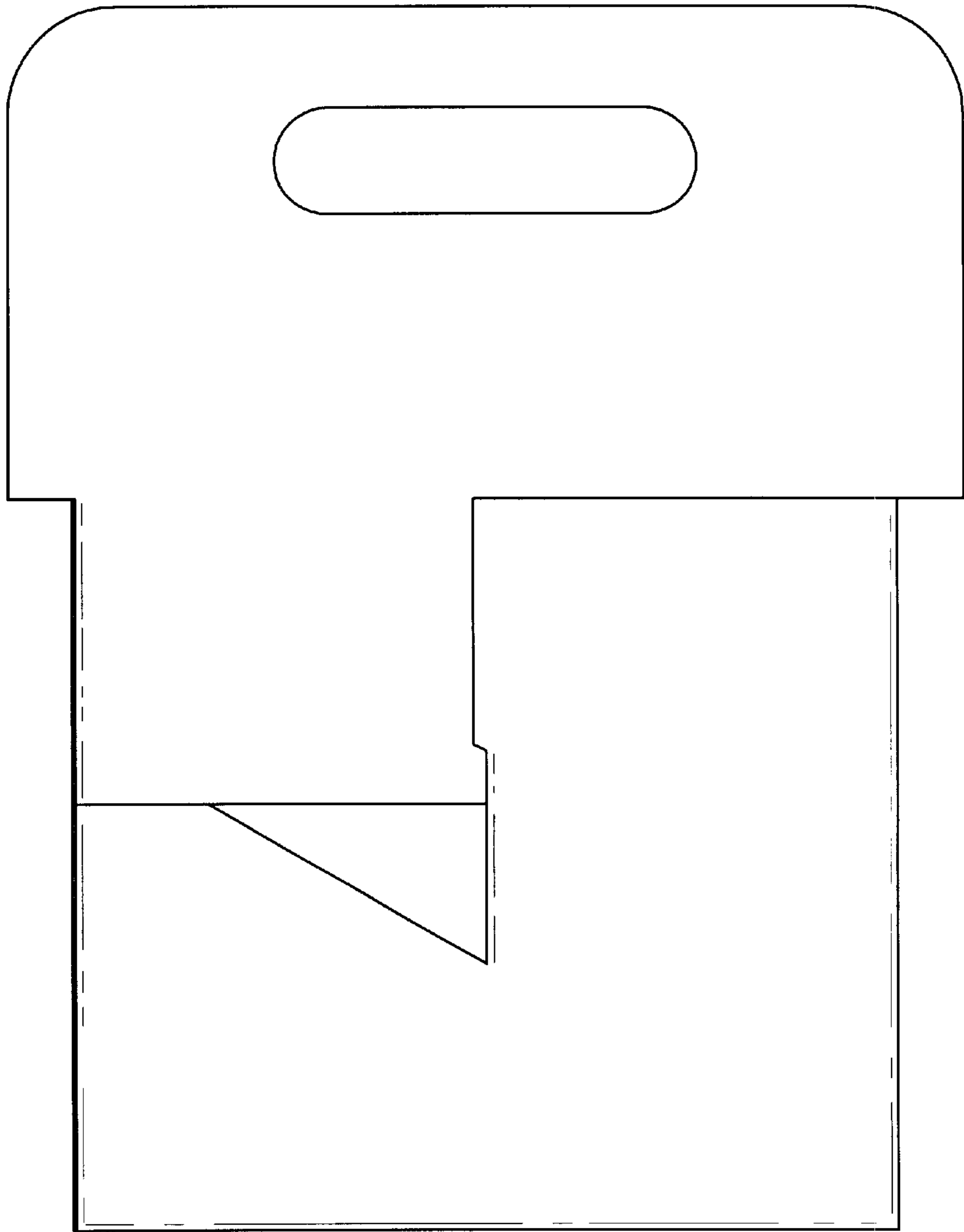
*FIG. 1*



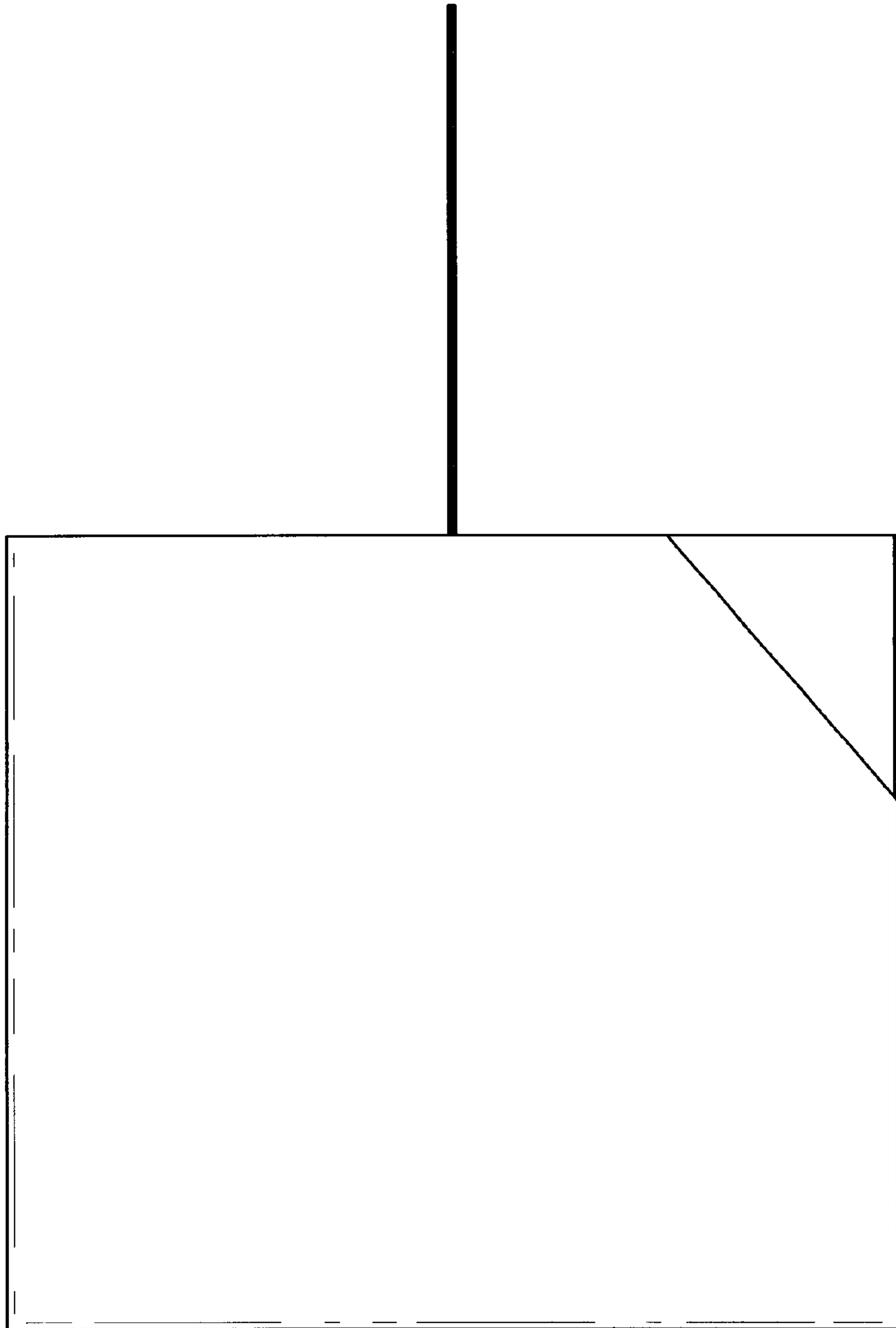
*FIG. 2*



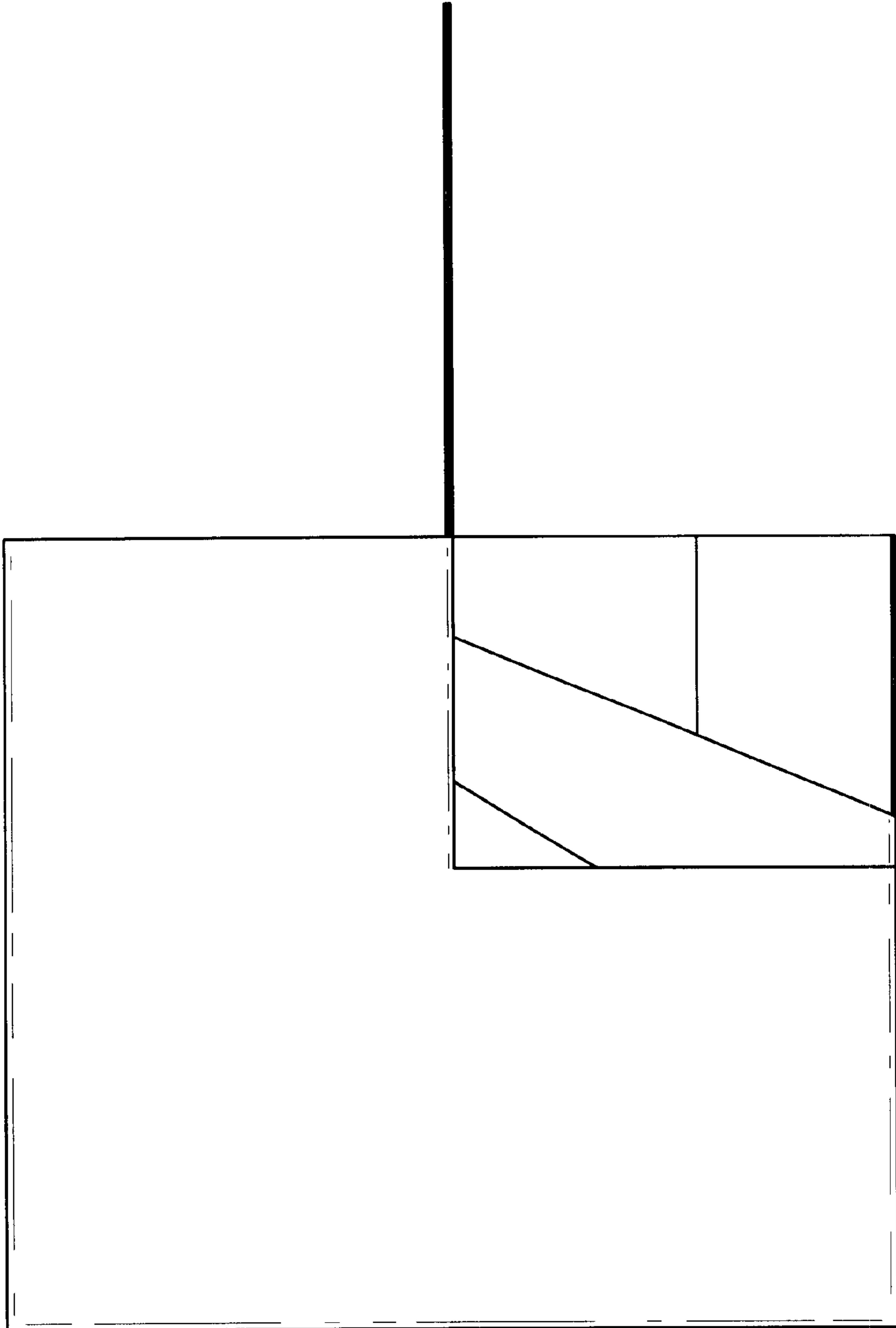
**FIG. 3**



**FIG. 4**

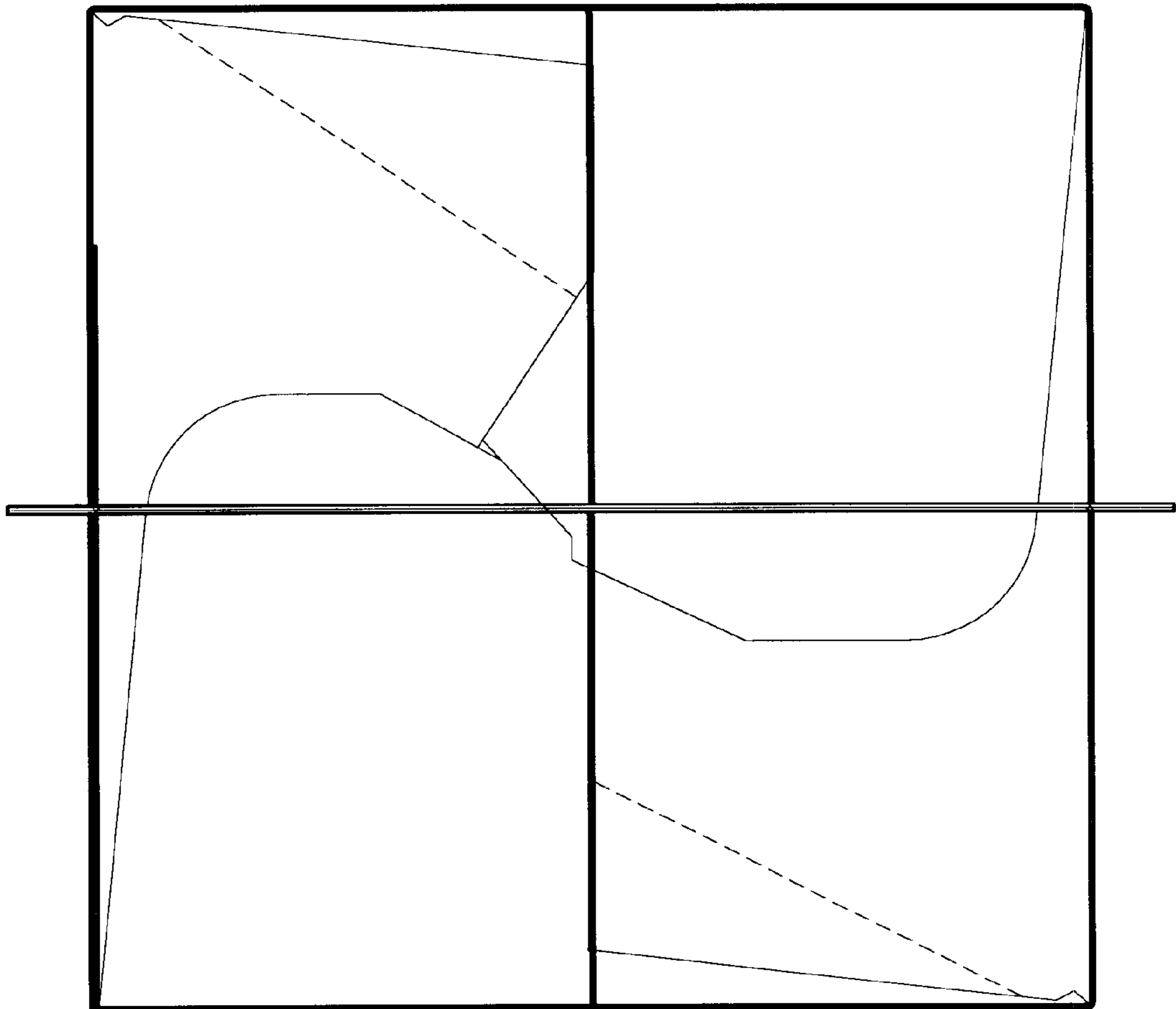


*FIG. 5*

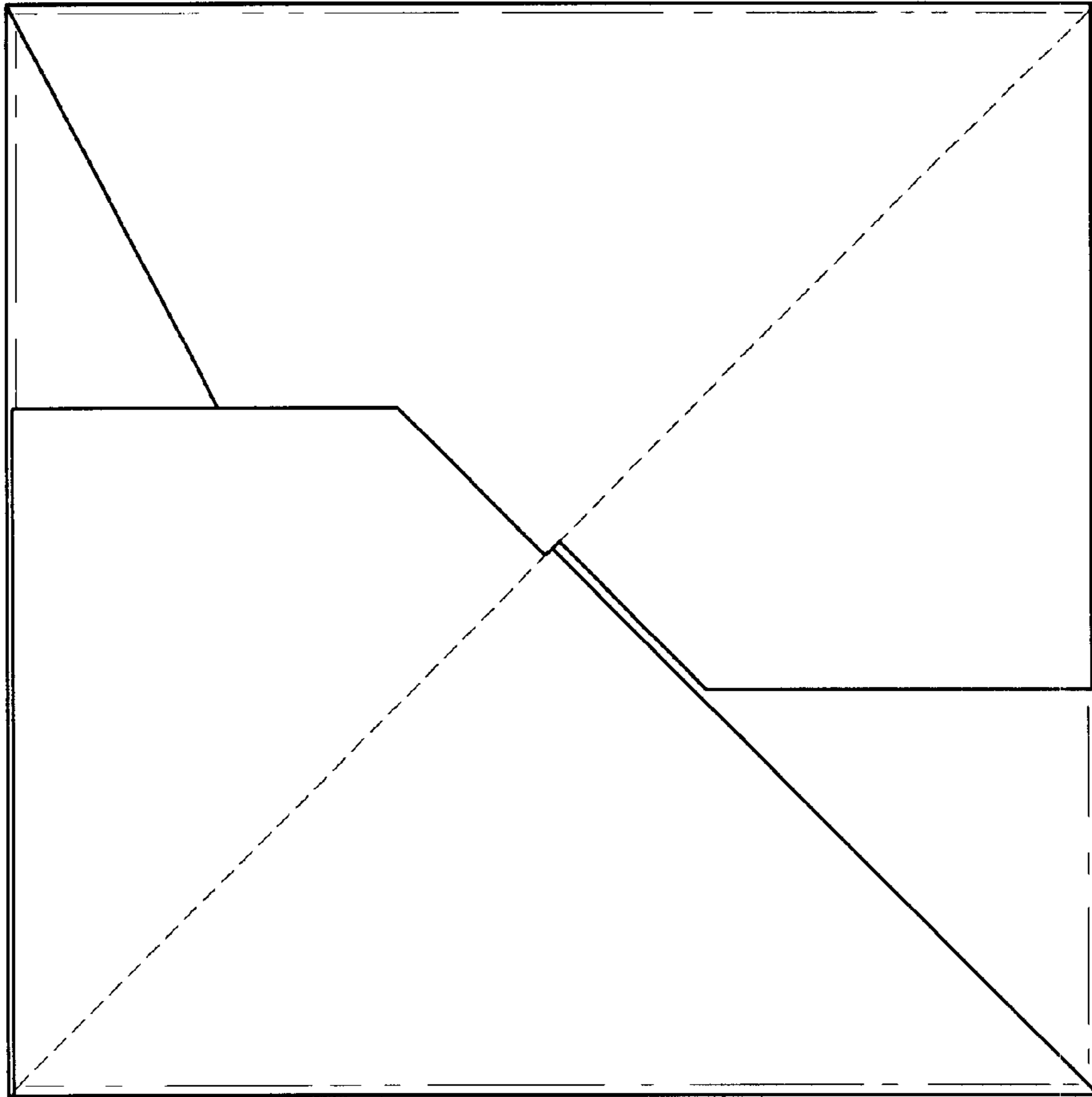


*FIG. 6*





*FIG. 7*



**FIG.8**

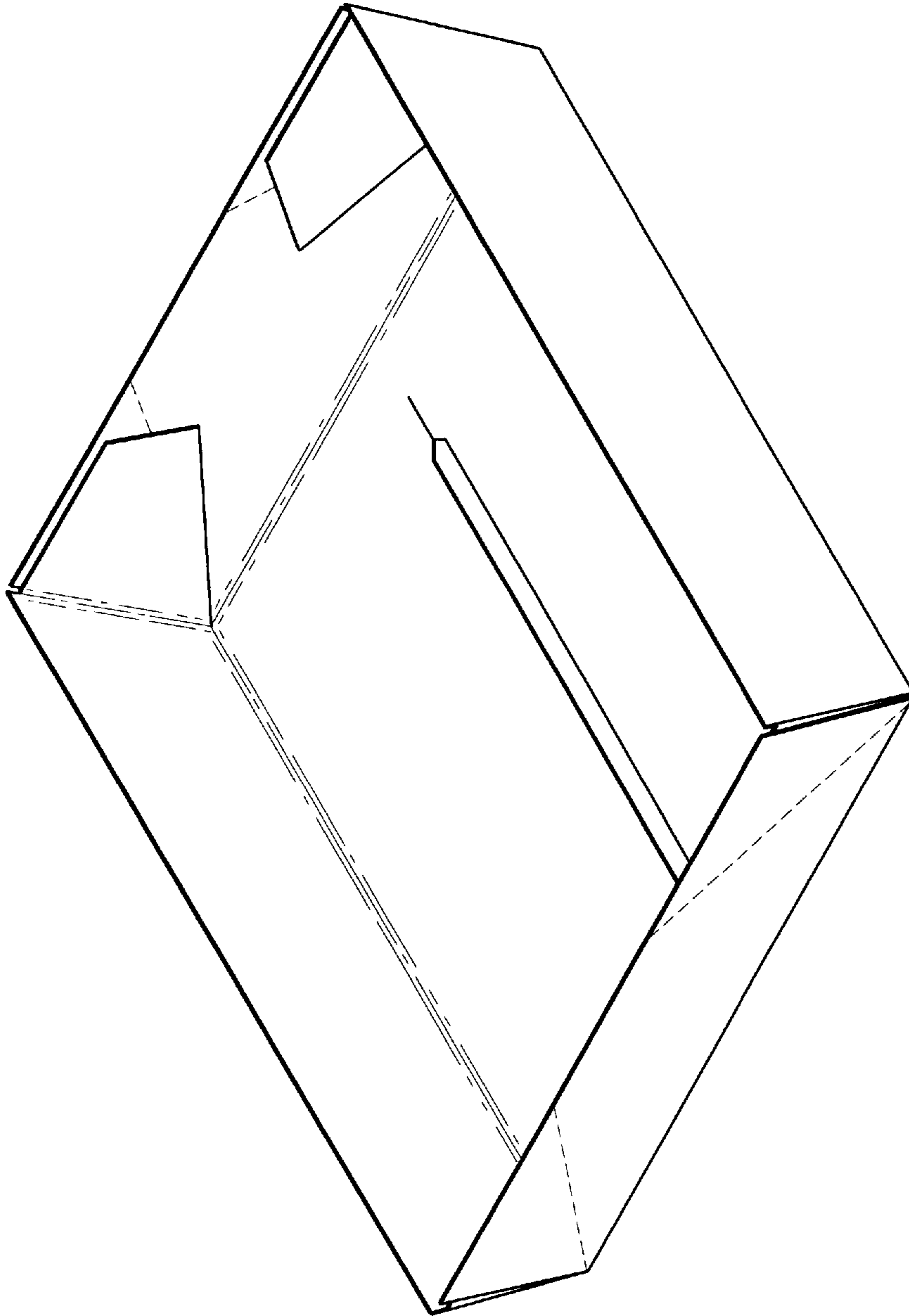


FIG. 9

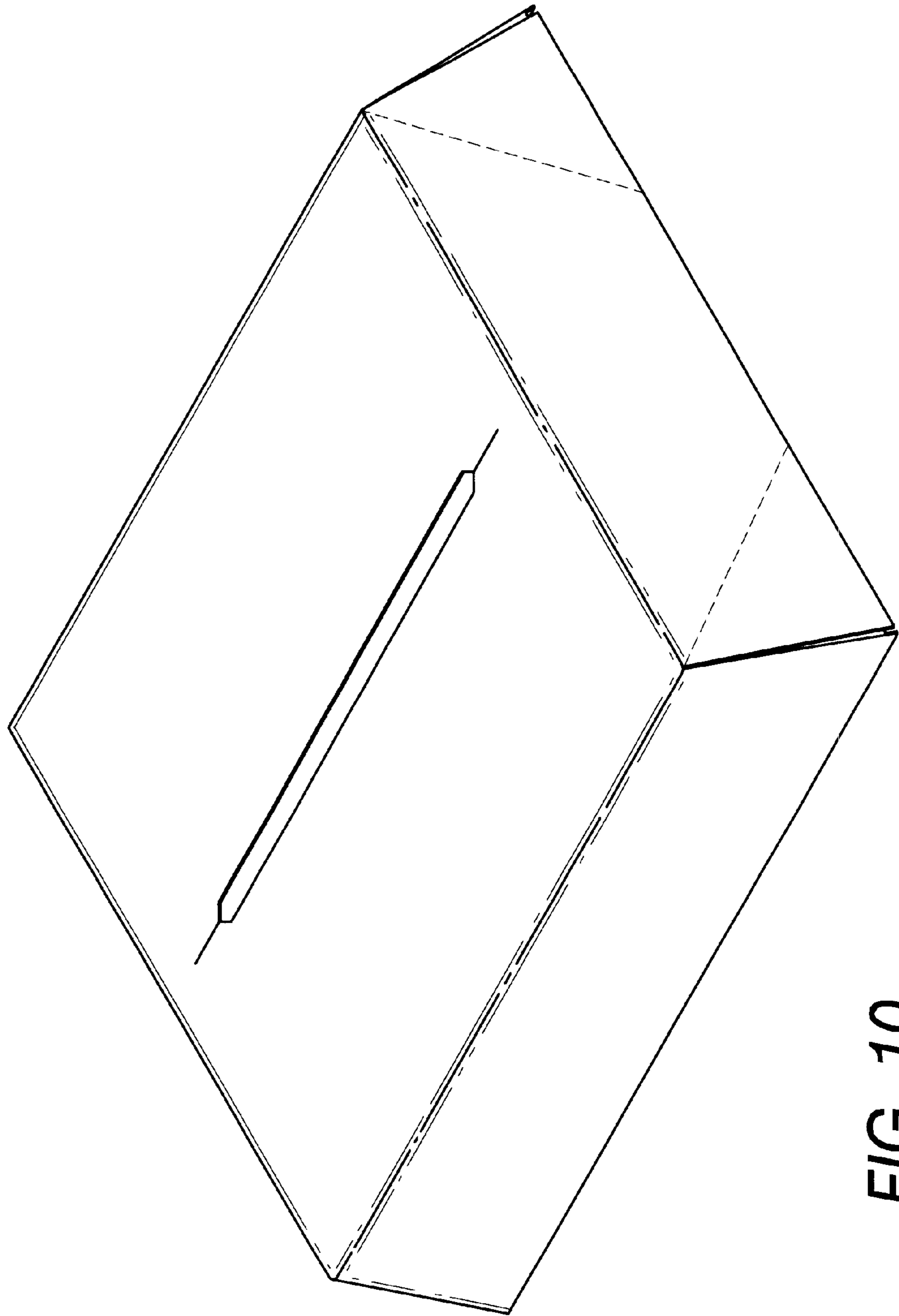


FIG. 10

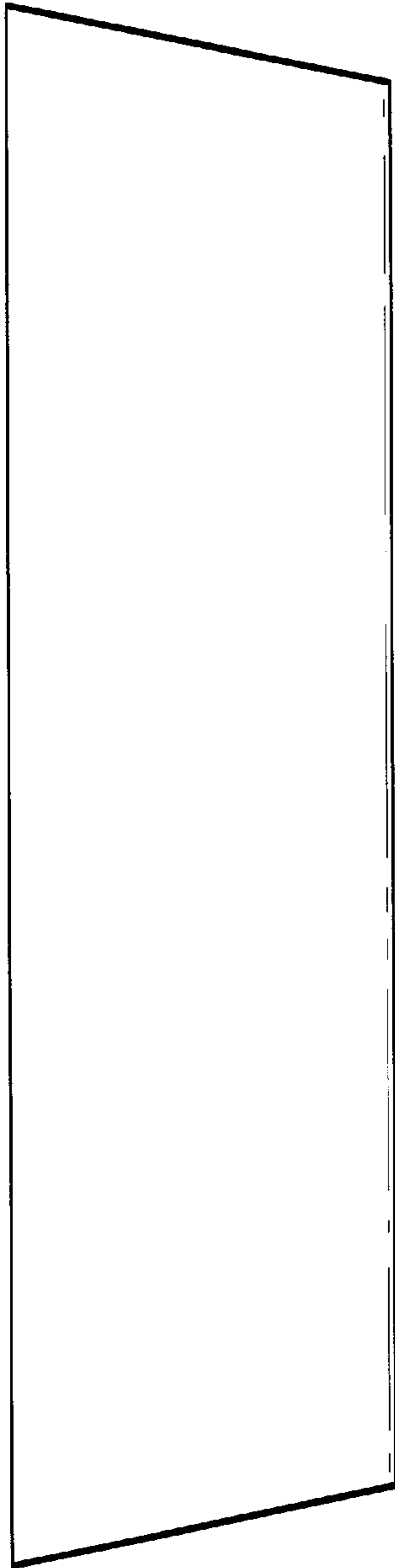


FIG. 11

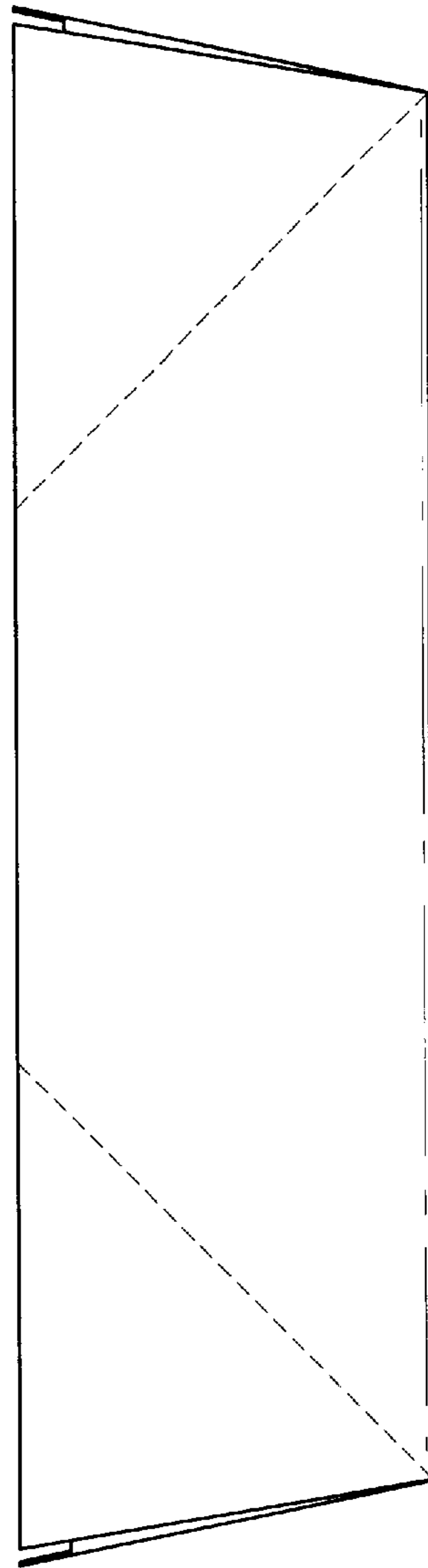


FIG. 12

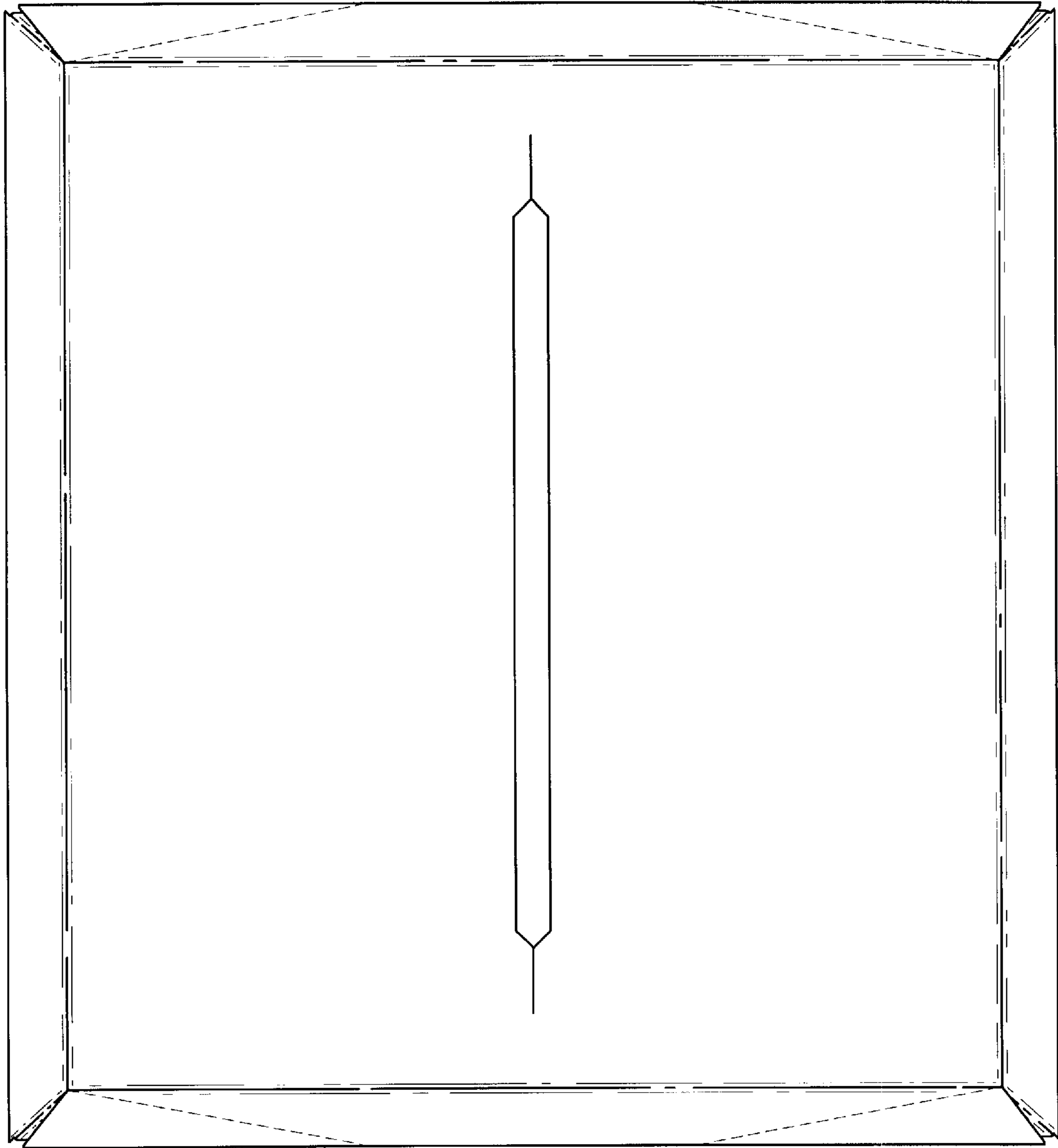


FIG. 13

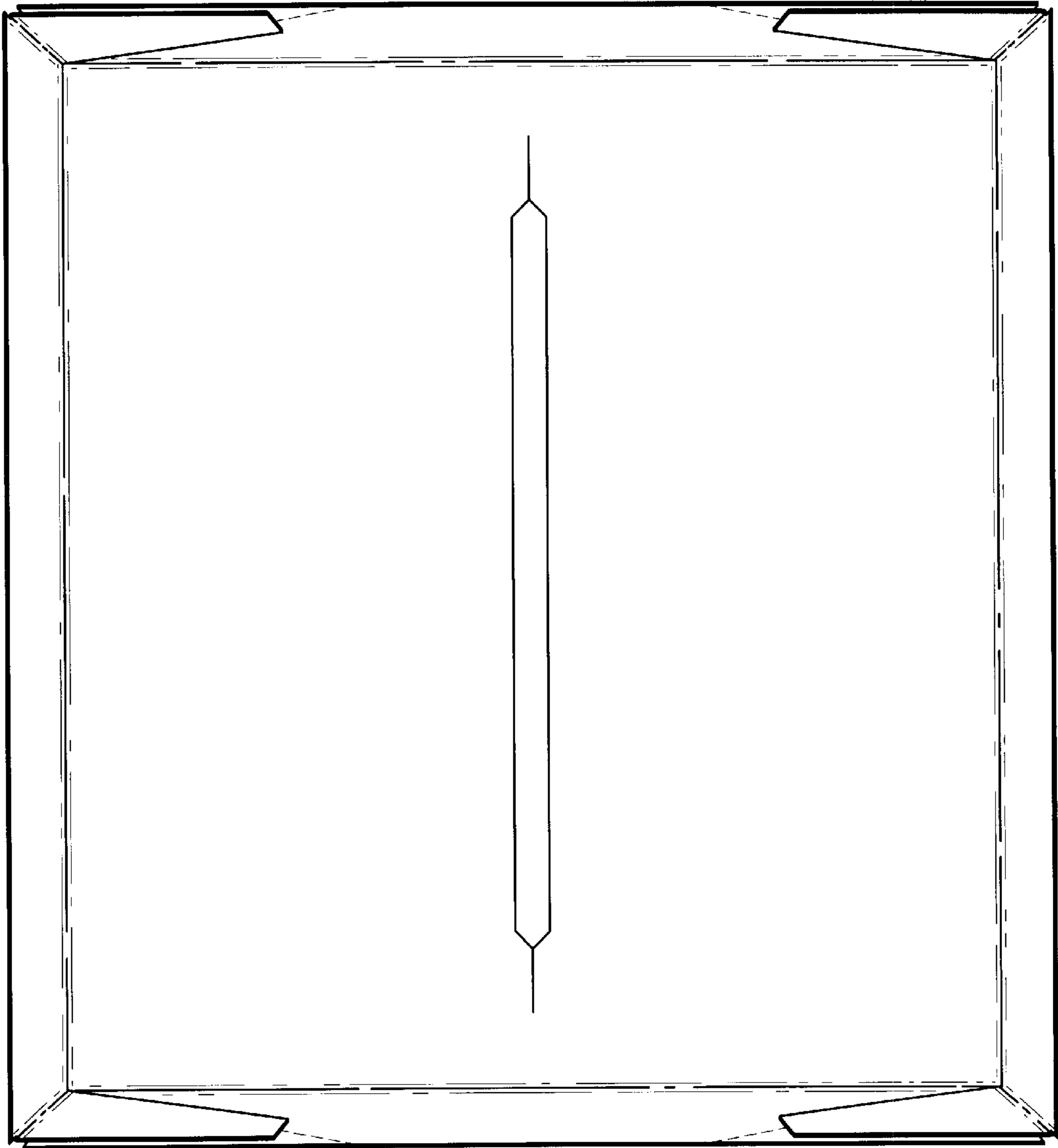


FIG. 14