



US00D461524S

(12) **United States Design Patent**
Lobermeier

(10) **Patent No.:** **US D461,524 S**

(45) **Date of Patent:** **** Aug. 13, 2002**

(54) **HAND SHOWER**

(75) Inventor: **Hans Lobermeier**, Menden (DE)

(73) Assignee: **Friedrich Grohe AG & Co. KG**,
Hemer (DE)

(**) Term: **14 Years**

(21) Appl. No.: **29/147,788**

(22) Filed: **Sep. 5, 2001**

(30) **Foreign Application Priority Data**

Mar. 28, 2001 (DE) 401 03 064

(51) **LOC (7) Cl.** **23-01**

(52) **U.S. Cl.** **D23/223**

(58) **Field of Search** D23/213, 223,
D23/226; 239/394, 525; 4/615

(56) **References Cited**

U.S. PATENT DOCUMENTS

D361,623 S * 8/1995 Huen D23/223
D424,162 S * 5/2000 Haug et al. D23/223

D424,164 S * 5/2000 Haug et al. D23/223
D428,110 S * 7/2000 Haug et al. D23/223
D432,625 S * 10/2000 Chan D23/223
D440,630 S * 4/2001 Gottwald D23/223

* cited by examiner

Primary Examiner—Robin V. Taylor

(74) *Attorney, Agent, or Firm*—Herbert Dubno

(57) **CLAIM**

The ornamental design for a hand shower, as shown and described.

DESCRIPTION

FIG. 1 is a bottom, front, left-side perspective view of a hand shower showing my new design;
FIG. 2 is a front elevational view thereof;
FIG. 3 is a right side elevational view thereof, the left side elevational view being mirror symmetrical thereto;
FIG. 4 is a rear elevational view thereof;
FIG. 5 is a bottom plan view thereof; and,
FIG. 6 is a top plan view thereof.

1 Claim, 6 Drawing Sheets

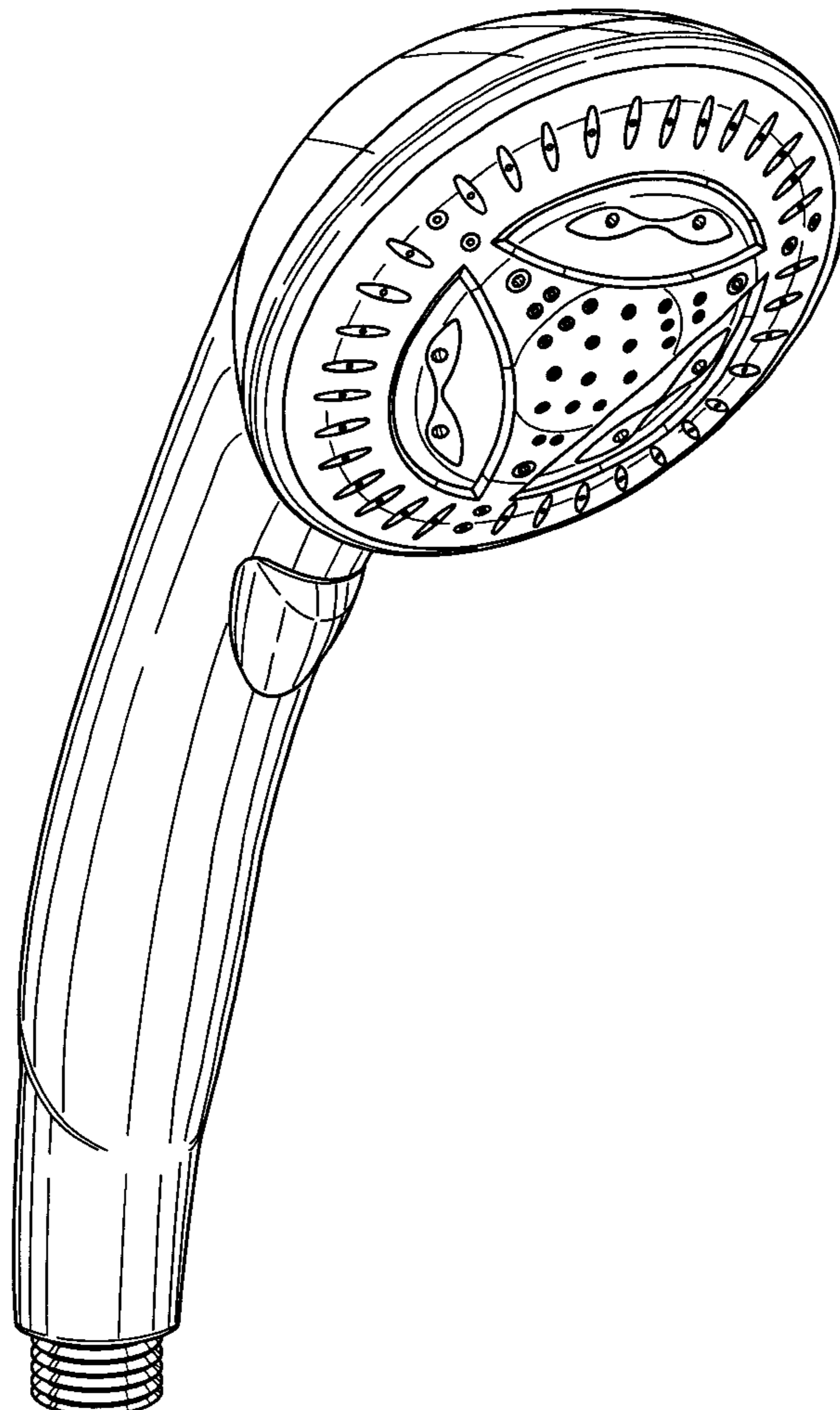

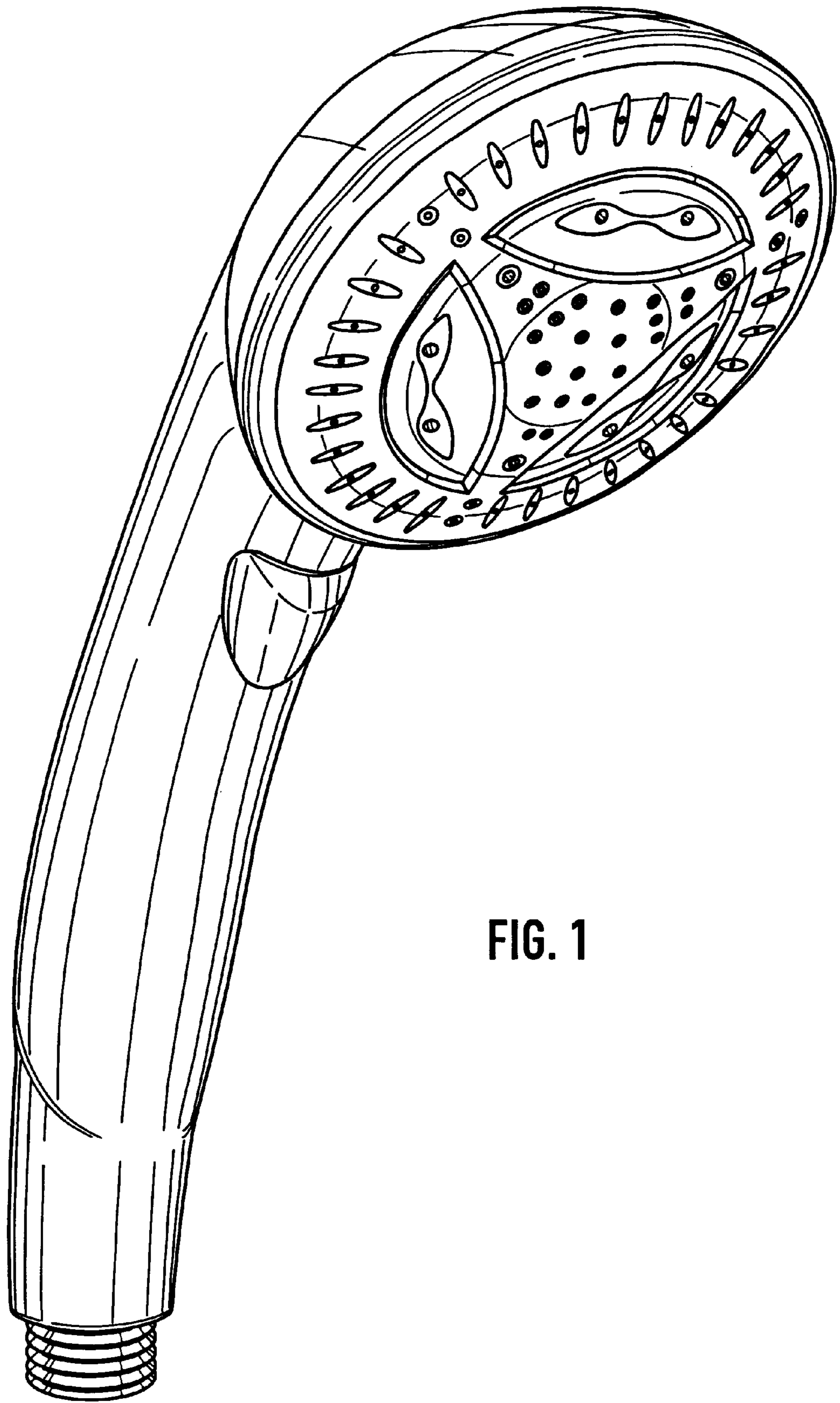

FIG. 1

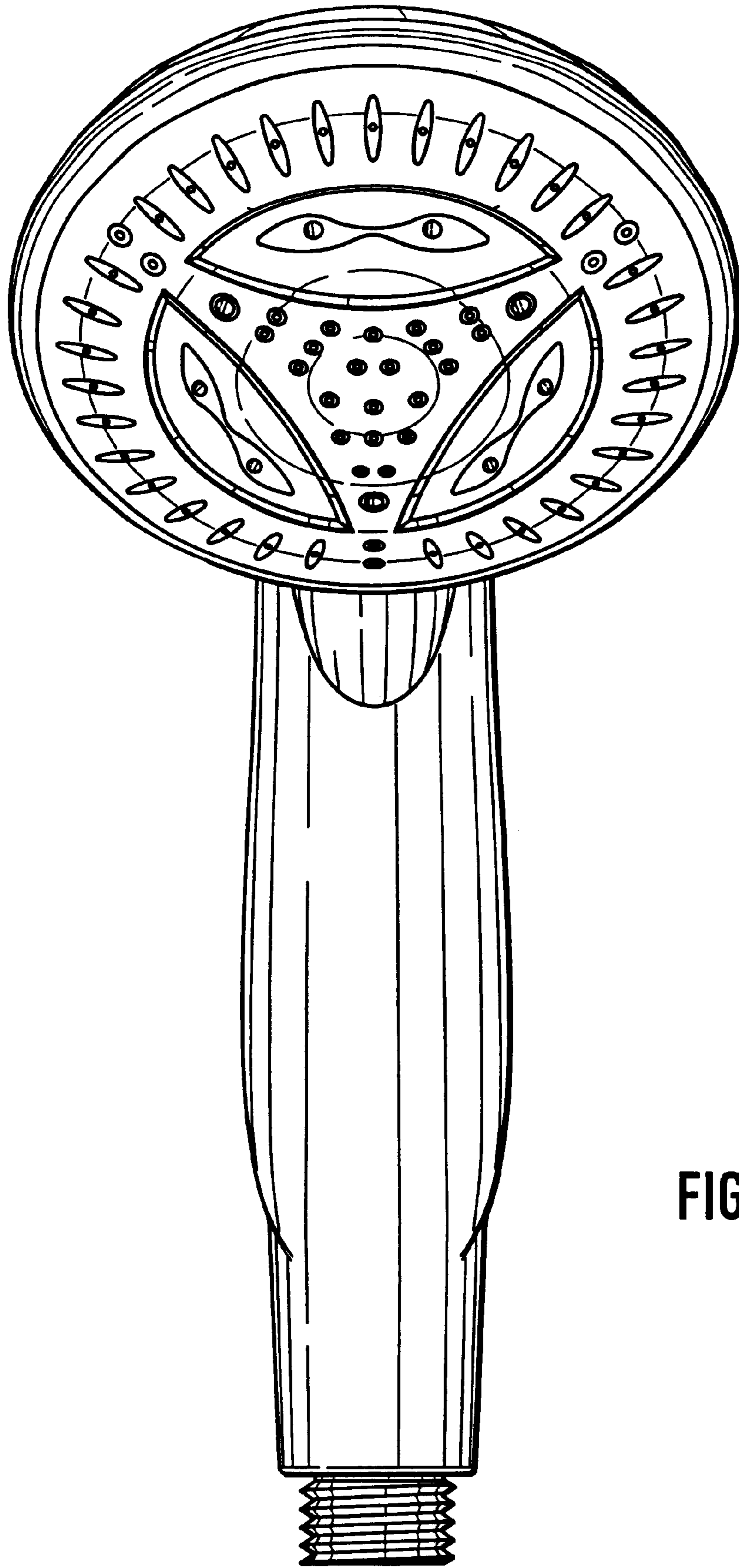

FIG. 2

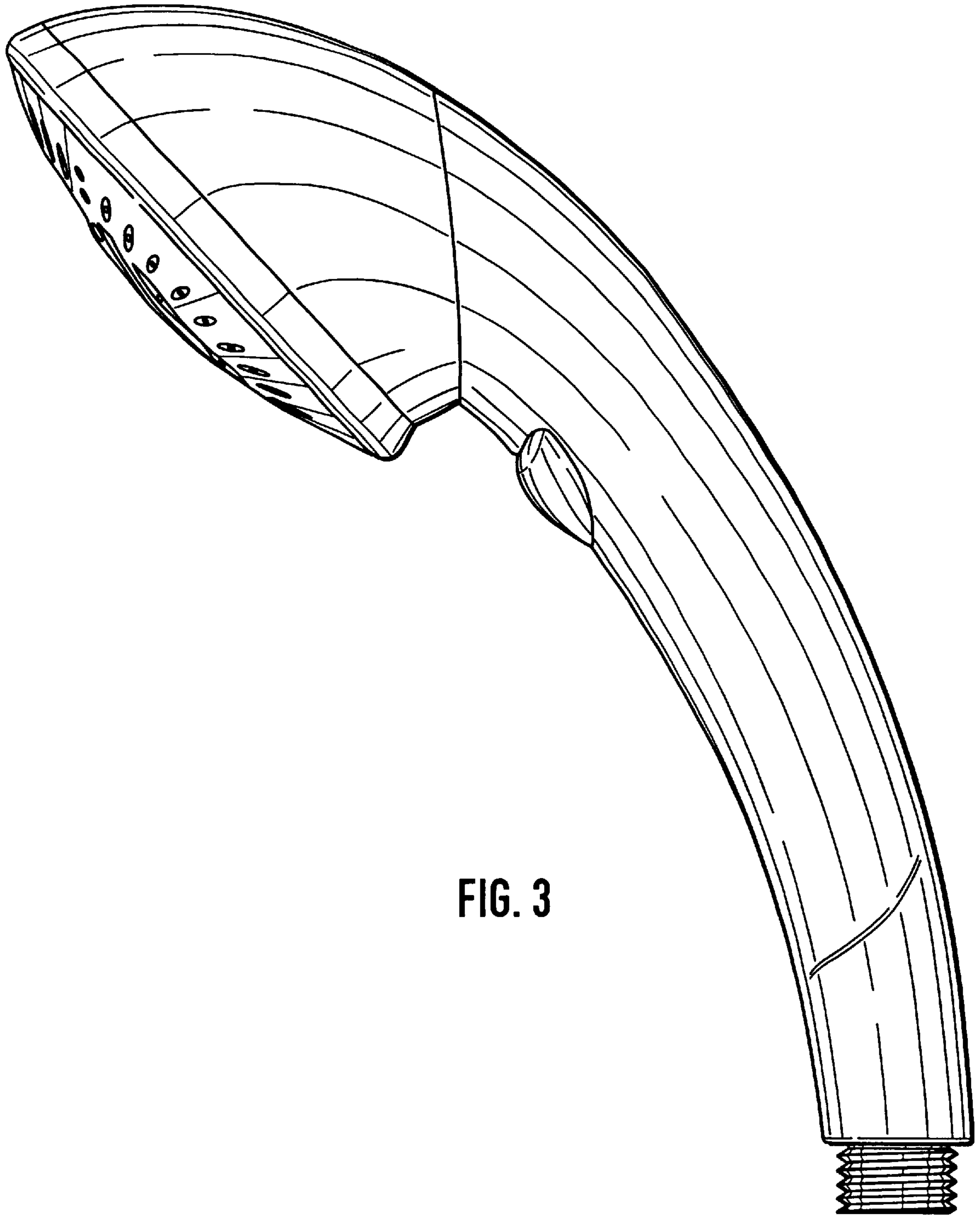

FIG. 3

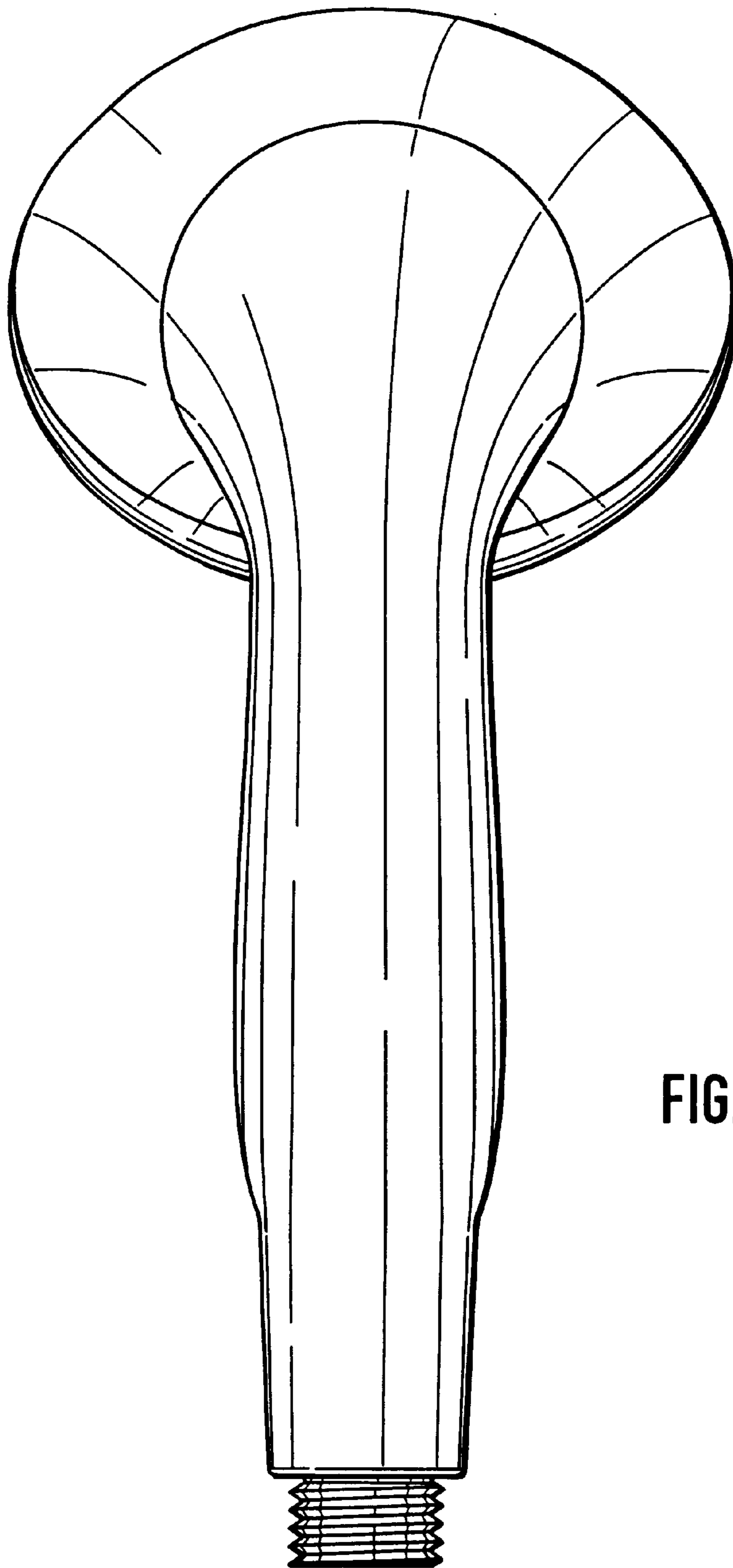

FIG. 4

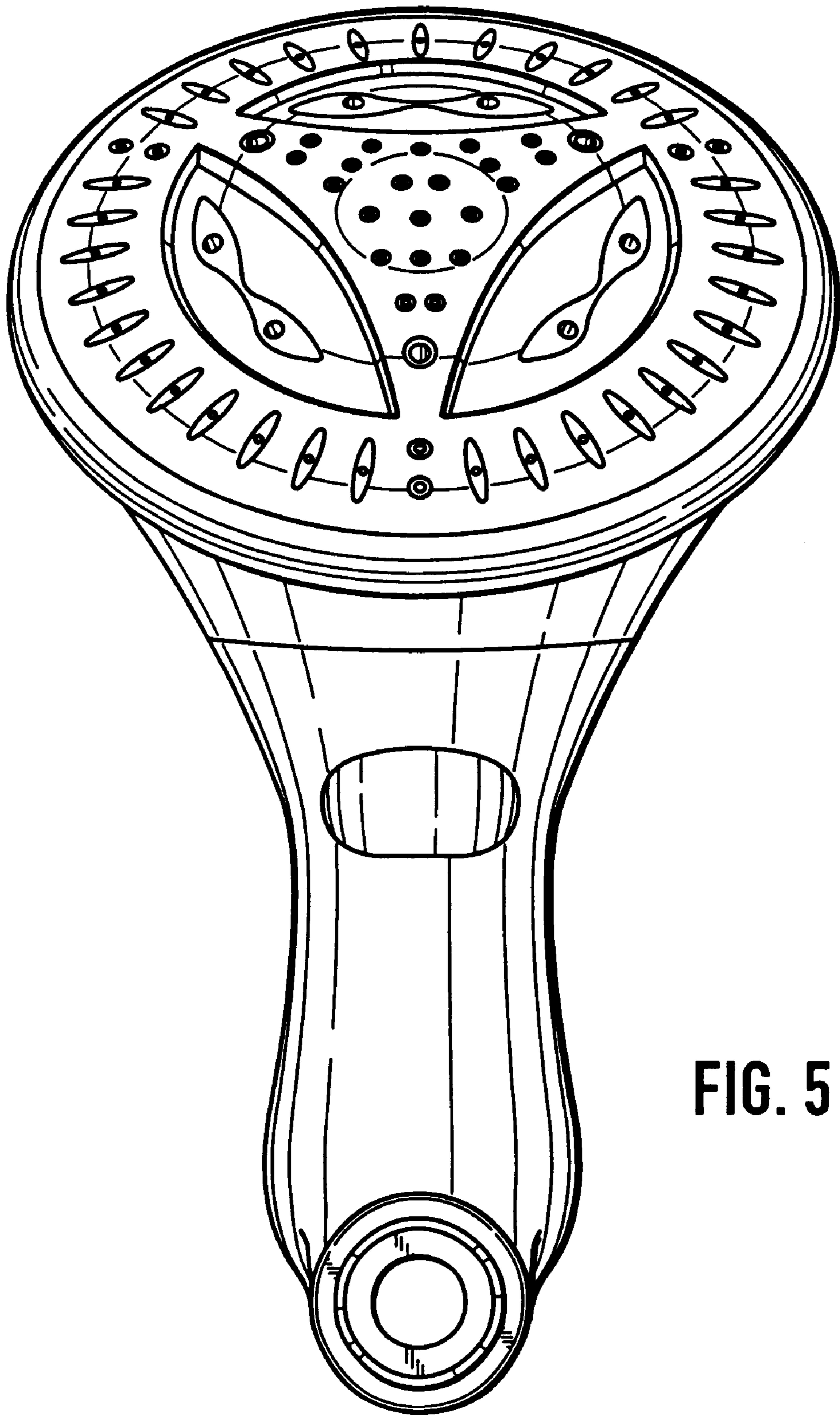

FIG. 5

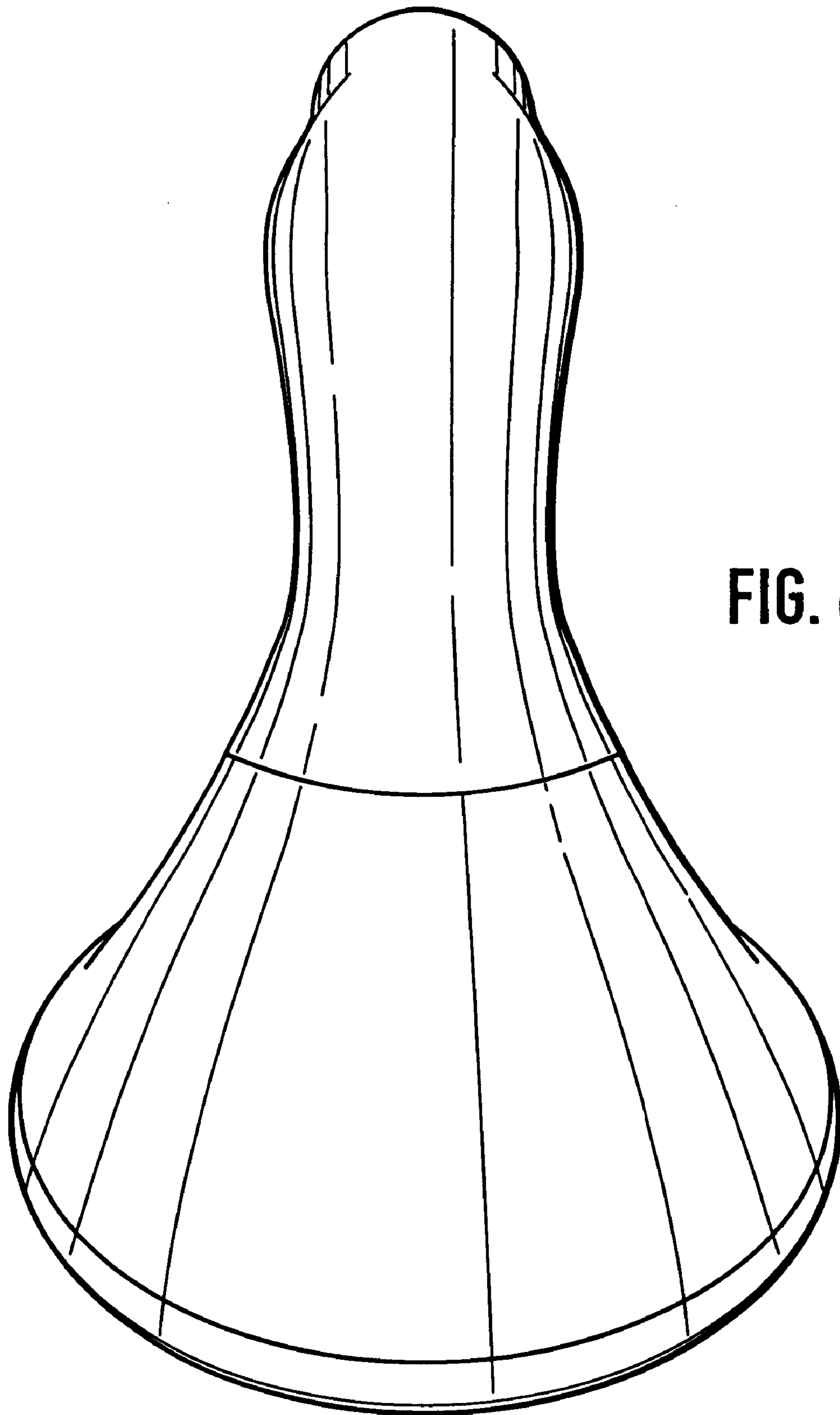

FIG. 6