



US00D461494S

(12) **United States Design Patent**
Tajima et al.

(10) **Patent No.:** **US D461,494 S**

(45) **Date of Patent:** **** Aug. 13, 2002**

(54) **PRINTING HEAD FOR PRINTER**

(75) Inventors: **Hiroki Tajima; Itaru Watanabe;**
Toshihiro Sasaki, all of Yokohama (JP)

(73) Assignee: **Canon Kabushiki Kaisha**, Tokyo (JP)

(**) Term: **14 Years**

(21) Appl. No.: **29/145,691**

(22) Filed: **Jul. 30, 2001**

(30) **Foreign Application Priority Data**

Feb. 8, 2001 (JP) 2001-002812

(51) **LOC (7) Cl.** **18-02**

(52) **U.S. Cl.** **D18/56**

(58) **Field of Search** D18/43, 56; 347/86,
347/87

(56) **References Cited**

U.S. PATENT DOCUMENTS

- D392,672 S * 3/1998 Inoue et al. D18/56
- D406,163 S * 2/1999 Shimizu et al. D18/56
- D409,236 S * 5/1999 Fujii et al. D18/56
- D412,526 S * 8/1999 Shimizu et al. D18/56
- D425,112 S * 5/2000 Shinada et al. D18/56
- D425,285 S * 5/2000 Shinada et al. 347/86
- D425,932 S * 5/2000 Shimizu et al. D18/56
- D431,833 S * 10/2000 Umemura D18/56

- D438,242 S * 2/2001 Chiba et al. D18/56
- D438,243 S * 2/2001 Chiba et al. D18/56
- D438,561 S * 3/2001 Chiba et al. D18/56
- D438,898 S * 3/2001 Chiba et al. D18/56
- D443,892 S * 6/2001 Sekine et al. D18/56

OTHER PUBLICATIONS

U.S. application Ser. No. 29/145,690, filed Jul. 30, 2001,
Tajima et al.

* cited by examiner

Primary Examiner—Cathy Anne MacCormac

(74) *Attorney, Agent, or Firm*—Fitzpatrick, Cella, Harper &
Scinto

(57) **CLAIM**

The ornamental design for a printing head for printer, as
shown and described.

DESCRIPTION

FIG. 1 is a front view of a printing head for printer showing
our new design;

FIG. 2 is a rear view thereof;

FIG. 3 is a top plan view thereof;

FIG. 4 is a bottom plan view thereof;

FIG. 5 is a left side view thereof;

FIG. 6 is a right side view thereof; and,

FIG. 7 is a perspective view thereof.

1 Claim, 4 Drawing Sheets

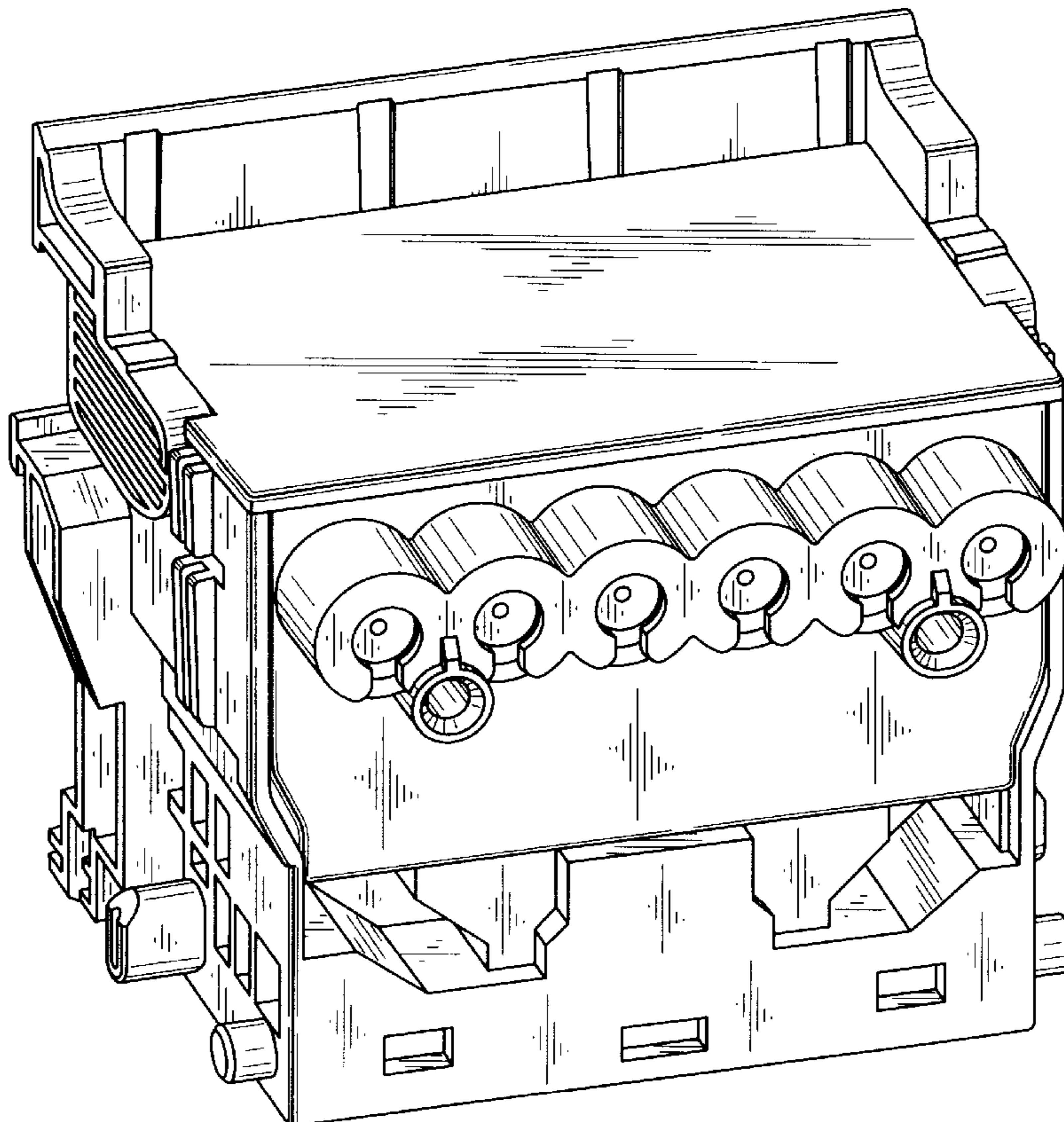

FIG. 1

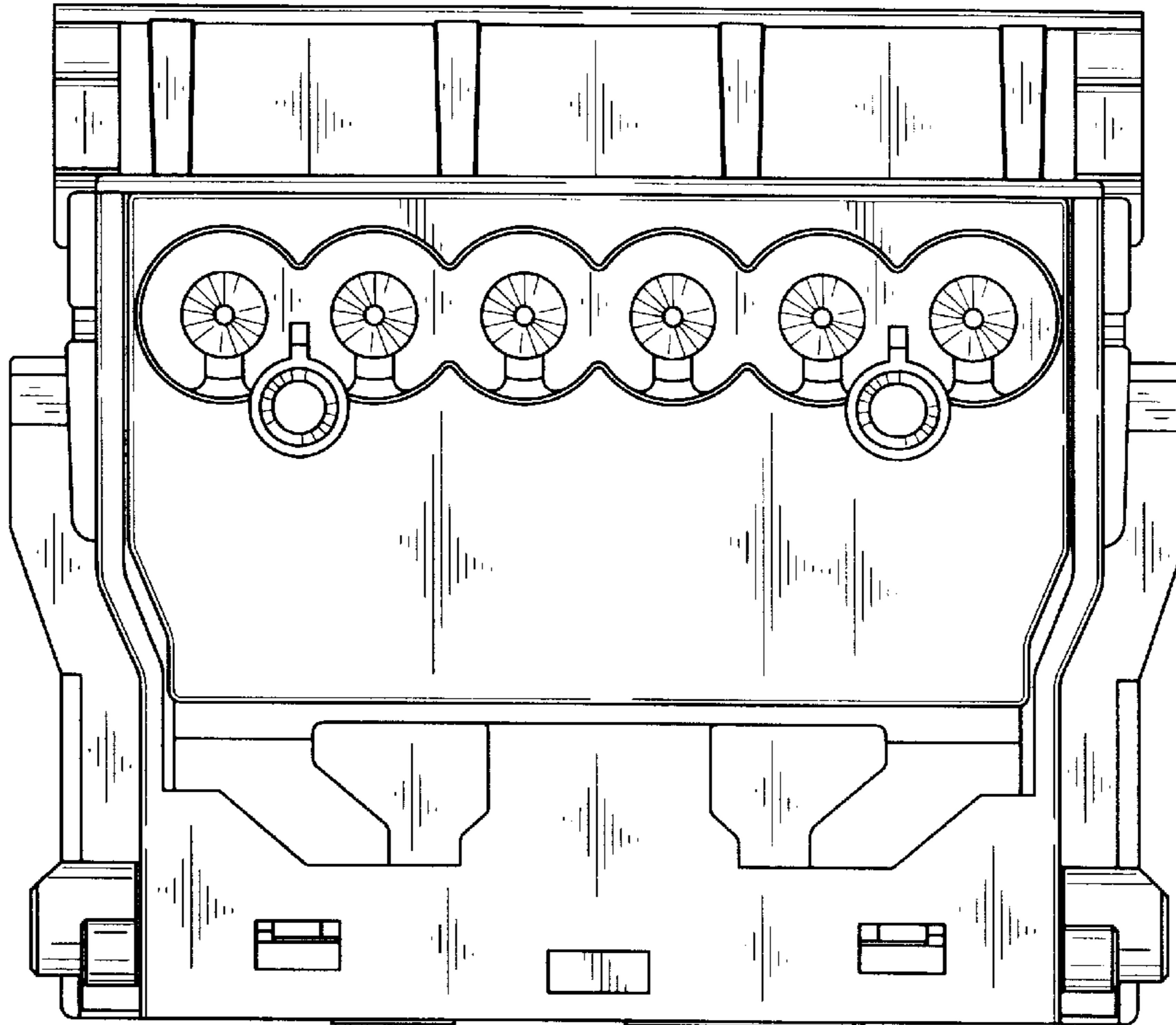

FIG. 2

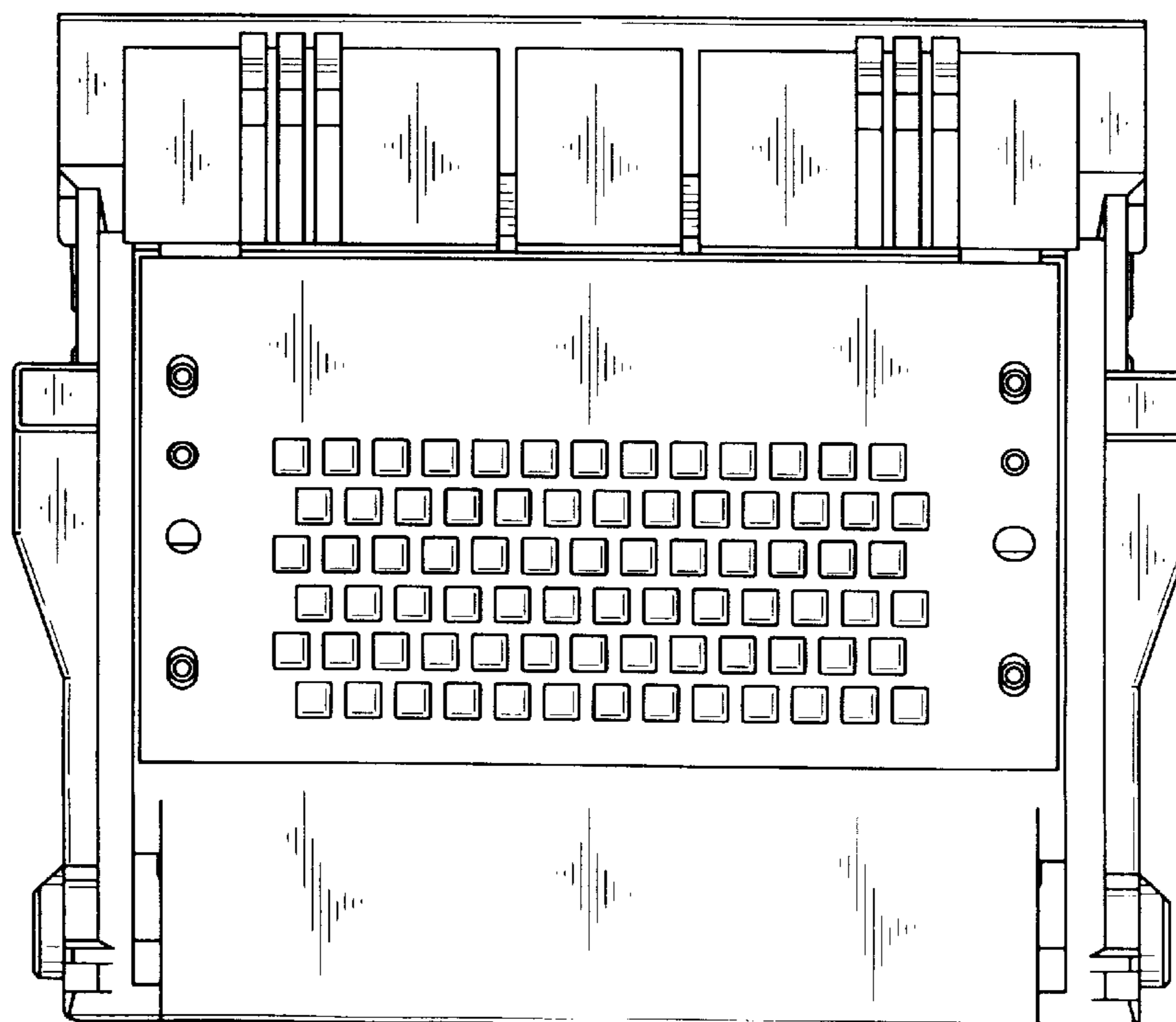

FIG. 3

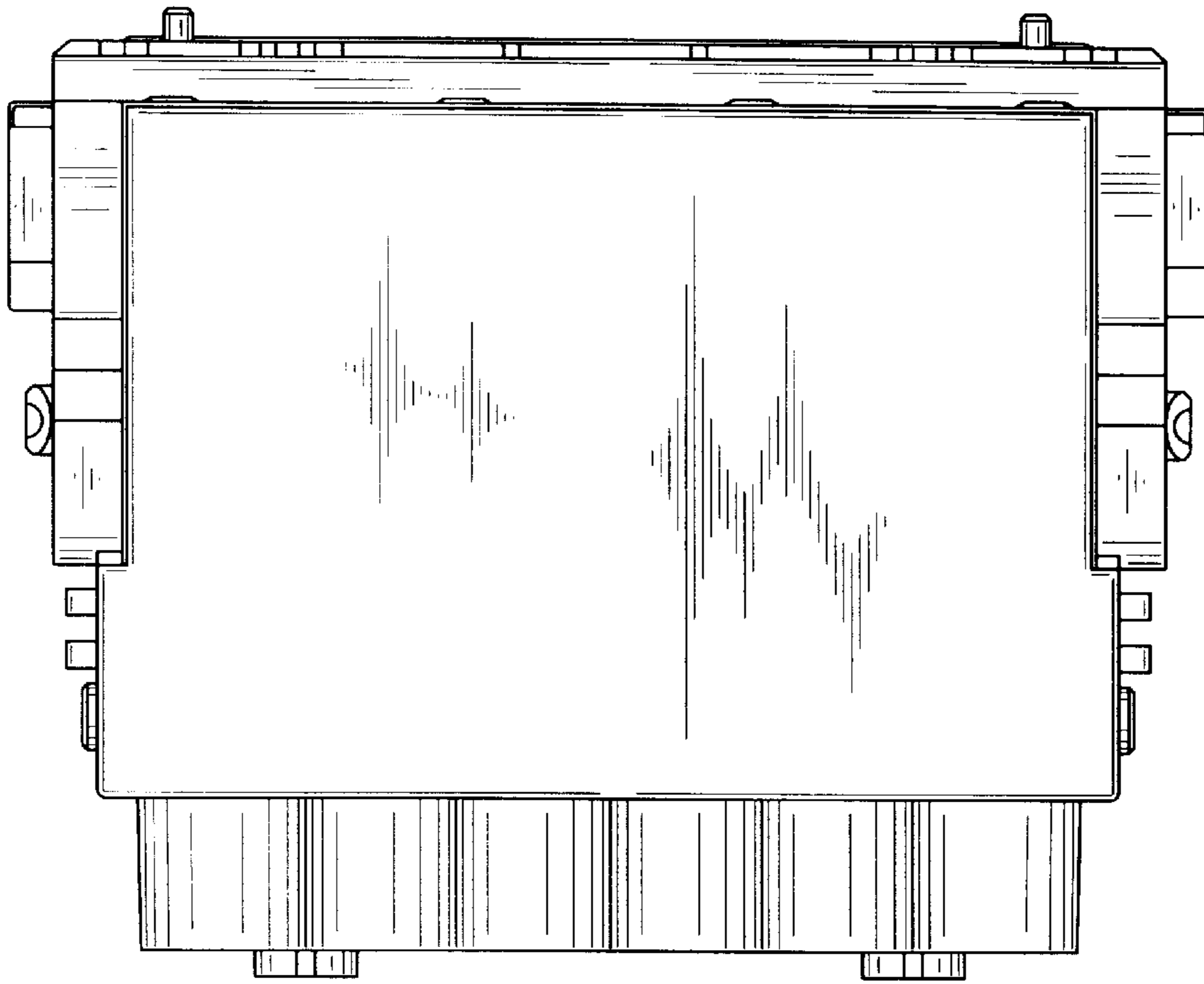

FIG. 4

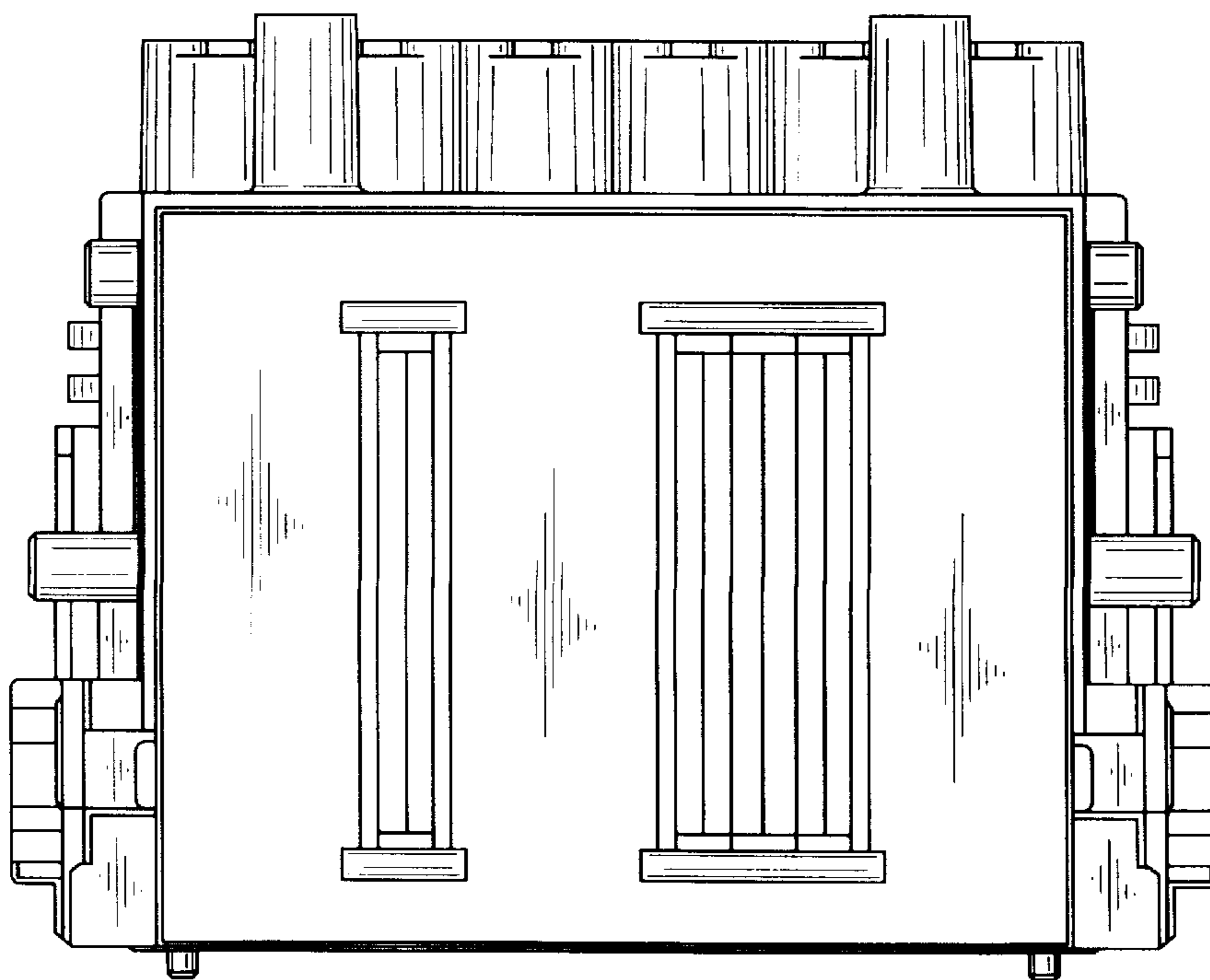

FIG. 5

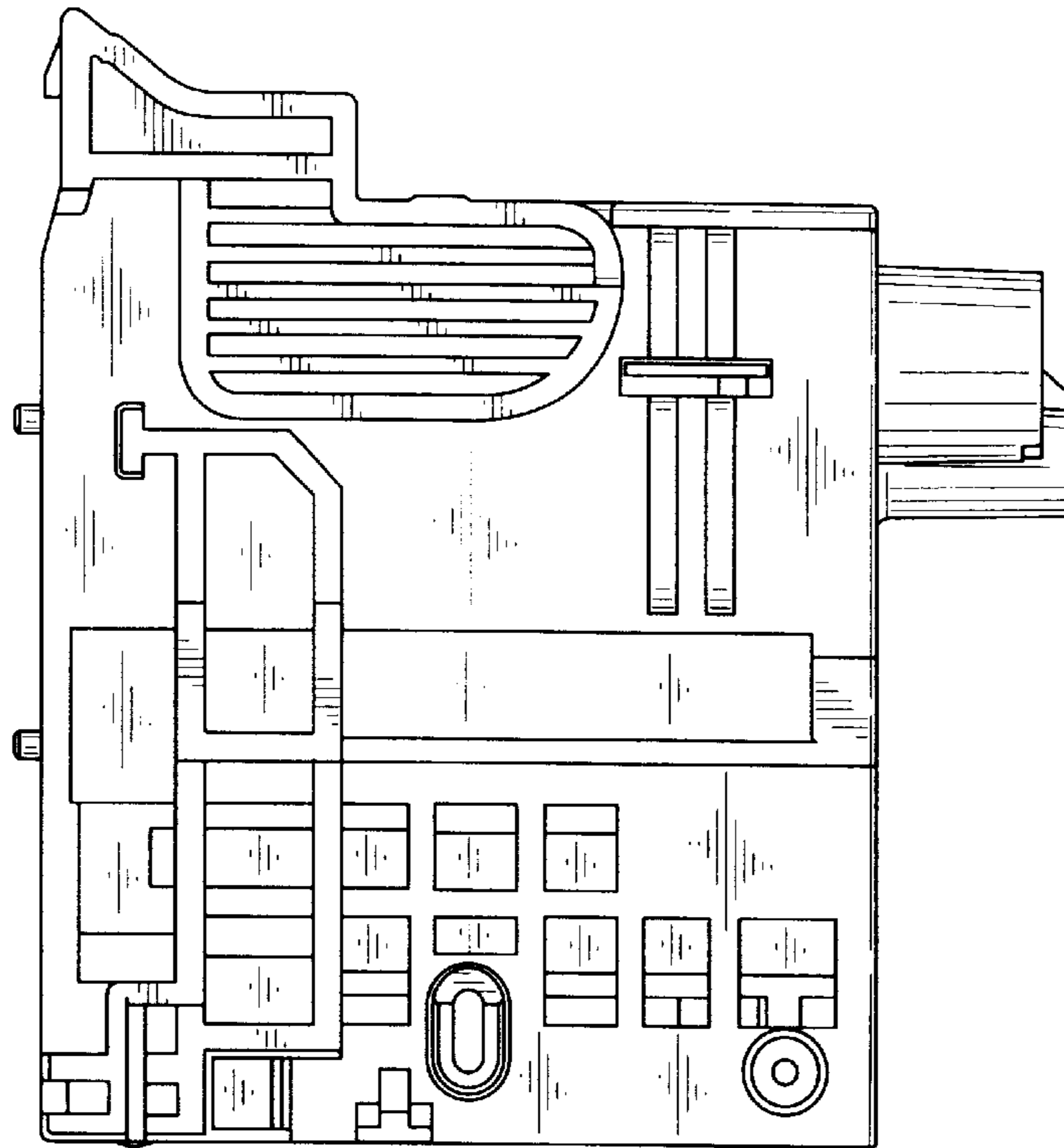

FIG. 6

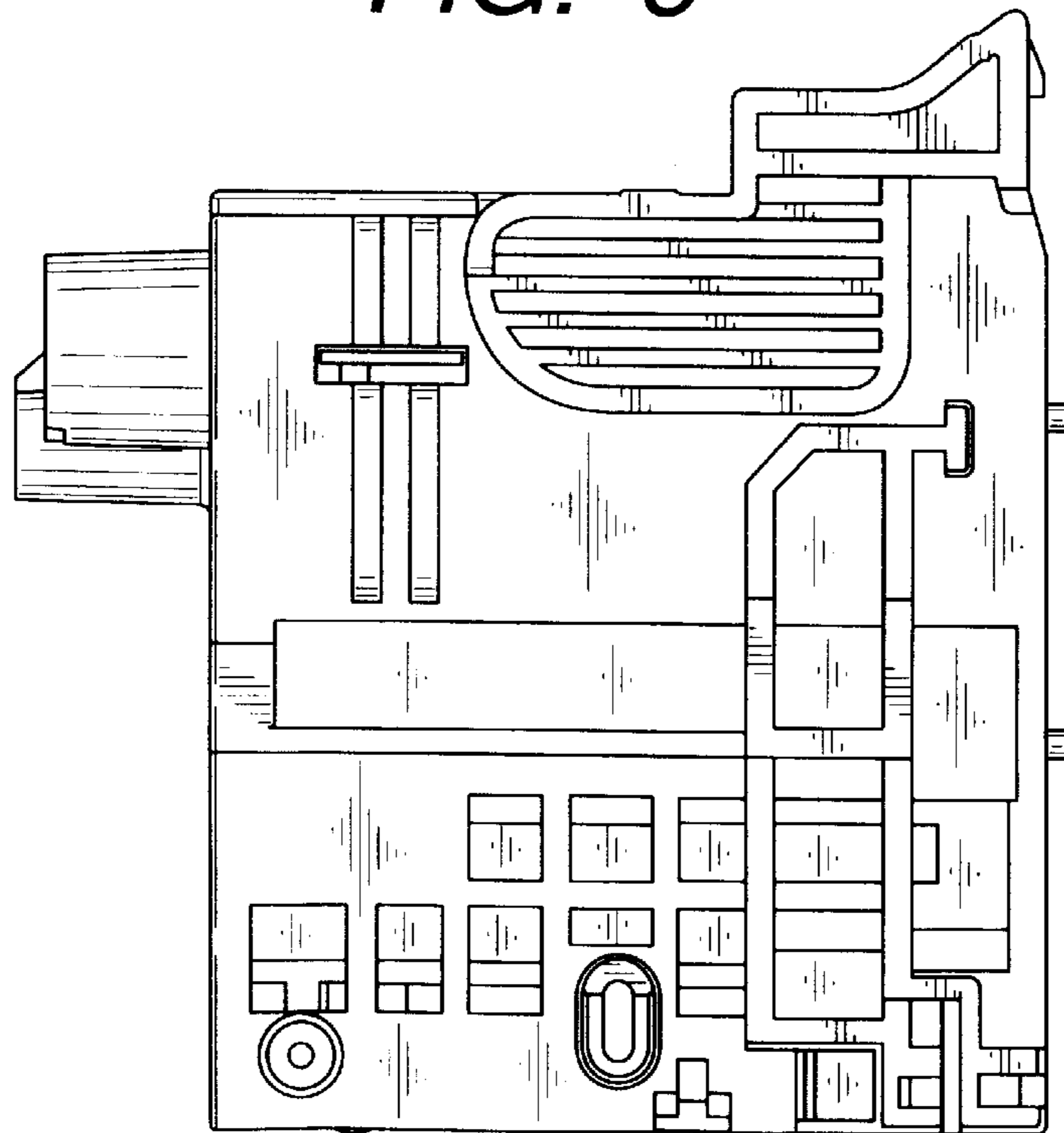

FIG. 7

