



US00D461489S

(12) **United States Design Patent**
Dituri et al.

(10) **Patent No.: US D461,489 S**

(45) **Date of Patent: ** Aug. 13, 2002**

(54) **GUITAR**

4,483,233 A * 11/1984 Benson 84/267
D279,102 S * 6/1985 Holmes D17/20

(75) Inventors: **Monica Maestrelli Dituri**, Bronxville,
NY (US); **Isabella Kron**, London (GB)

OTHER PUBLICATIONS

(73) Assignee: **Guccio Gucci S.p.A.**, Florence (IT)

The Music Trades, Jan. 1988 p.69.*

(**) Term: **14 Years**

* cited by examiner

(21) Appl. No.: **29/135,175**

Primary Examiner—Adir Aronovich

(22) Filed: **Jan. 8, 2001**

(74) *Attorney, Agent, or Firm*—Rothwell, Figg, Ernst &
Manbeck, P.C.

(30) **Foreign Application Priority Data**

(57) **CLAIM**

Jul. 7, 2000 (IT) TO0000151

The ornamental design for a guitar, as shown and described.

(51) **LOC (7) Cl.** **17-03**

DESCRIPTION

(52) **U.S. Cl.** **D17/14**

FIG. 1 is a front perspective view of a guitar showing the
new design;

(58) **Field of Search** D17/14, 18, 19,
D17/20; 84/267, 291, 293, 743

FIG. 2 is a front view thereof;

FIG. 3 is a right view thereof;

FIG. 4 is a left view thereof;

FIG. 5 is a rear view thereof;

FIG. 6 is a top view thereof; and,

FIG. 7 is a bottom view thereof.

(56) **References Cited**

U.S. PATENT DOCUMENTS

D208,500 S * 9/1967 Ross D17/14
3,524,377 A * 8/1970 Desmond 84/267
3,911,777 A * 10/1975 Rendell 84/743

1 Claim, 4 Drawing Sheets

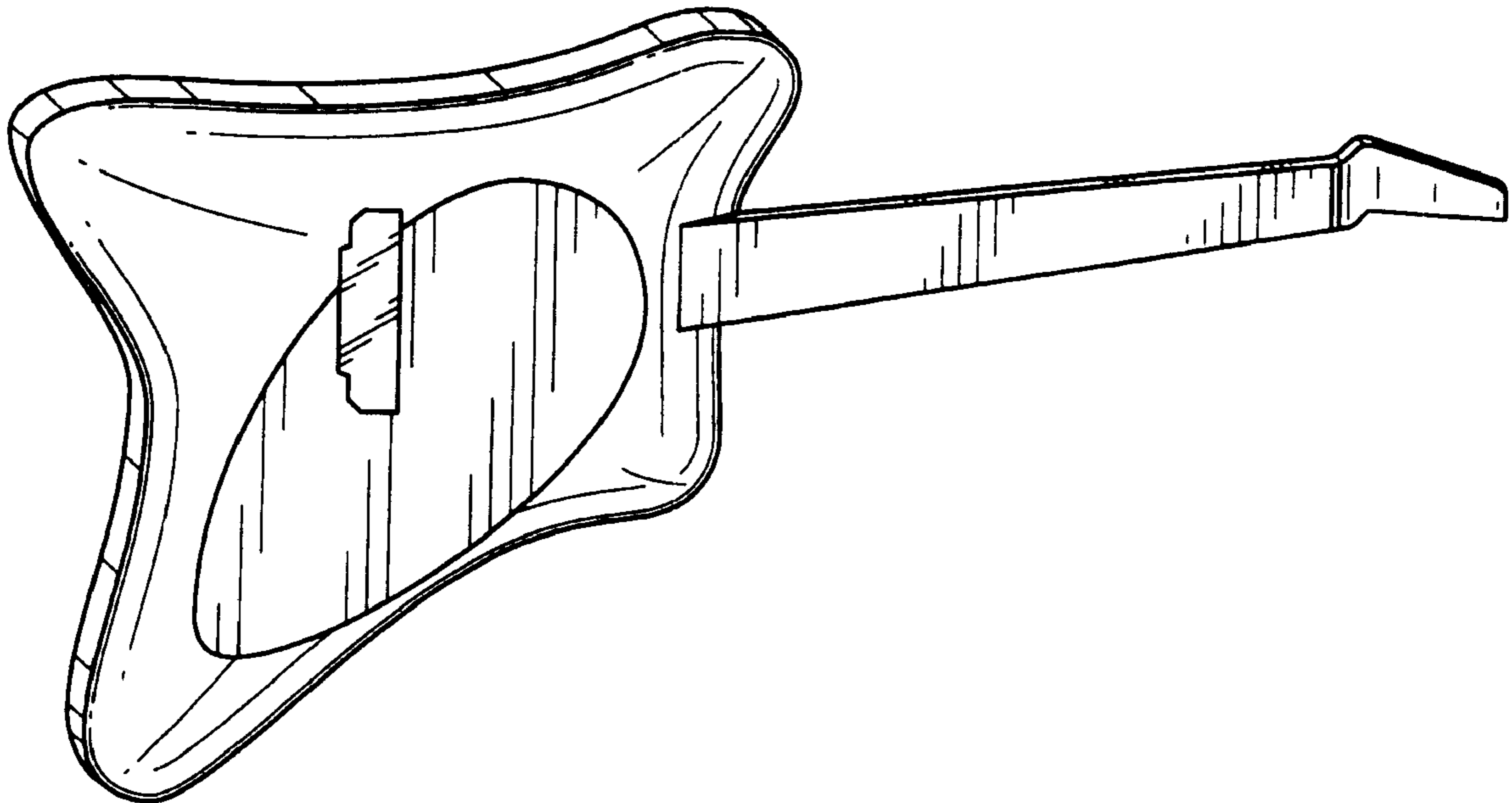

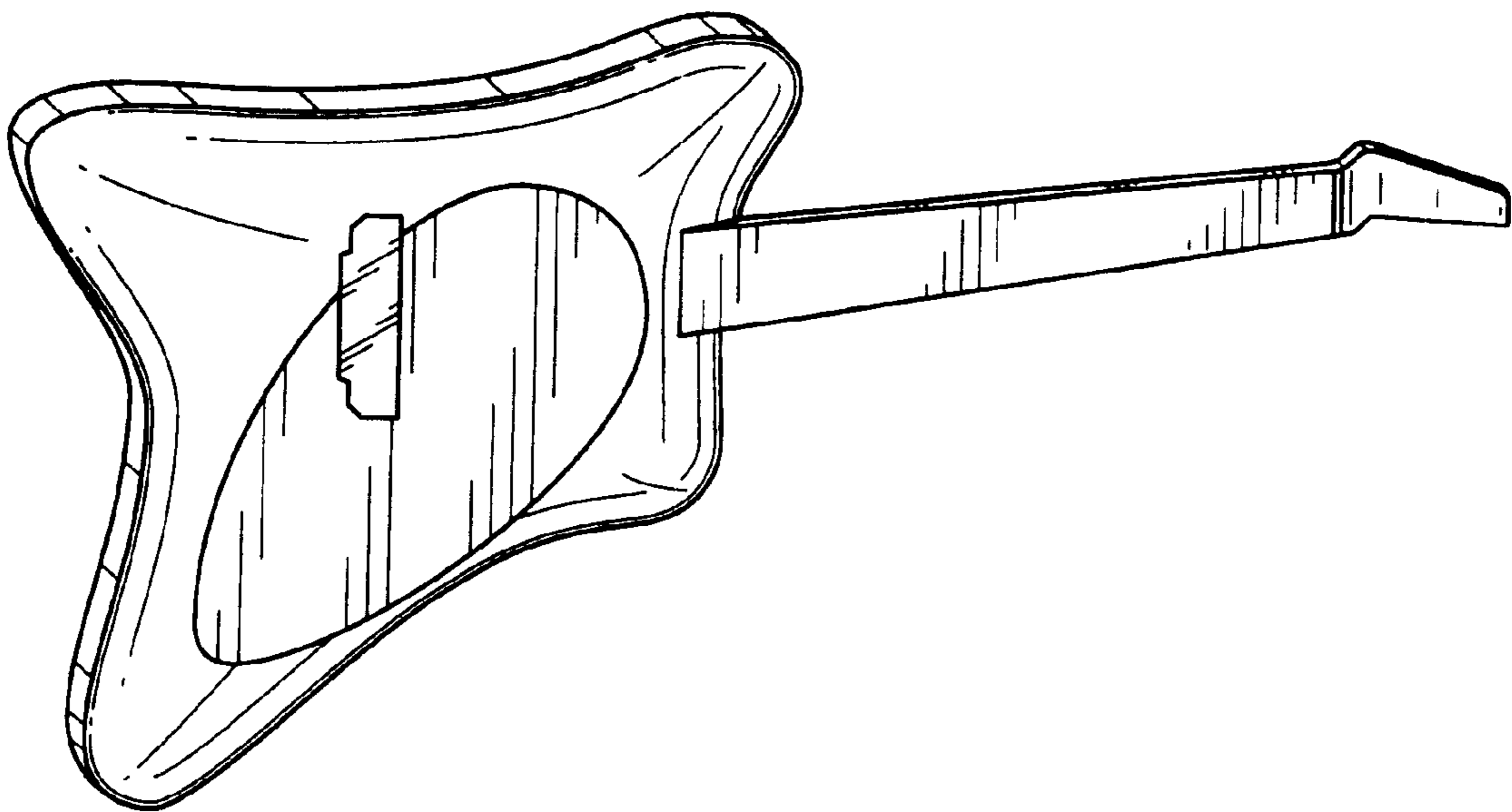

FIG. 1

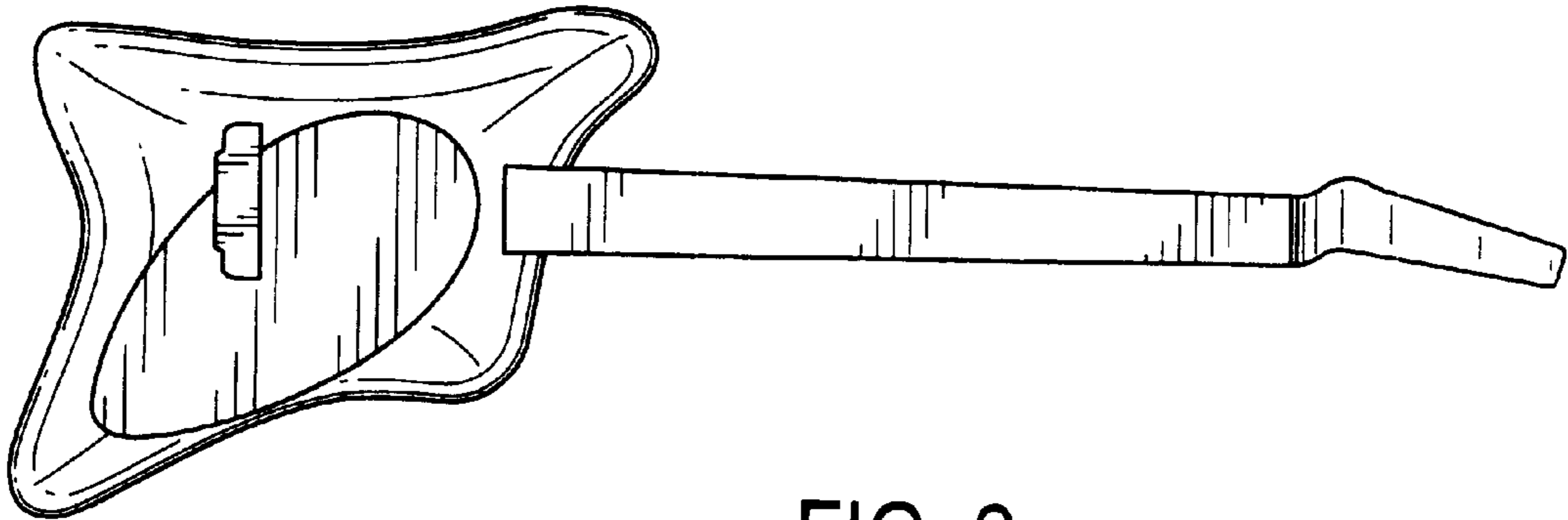

FIG. 2

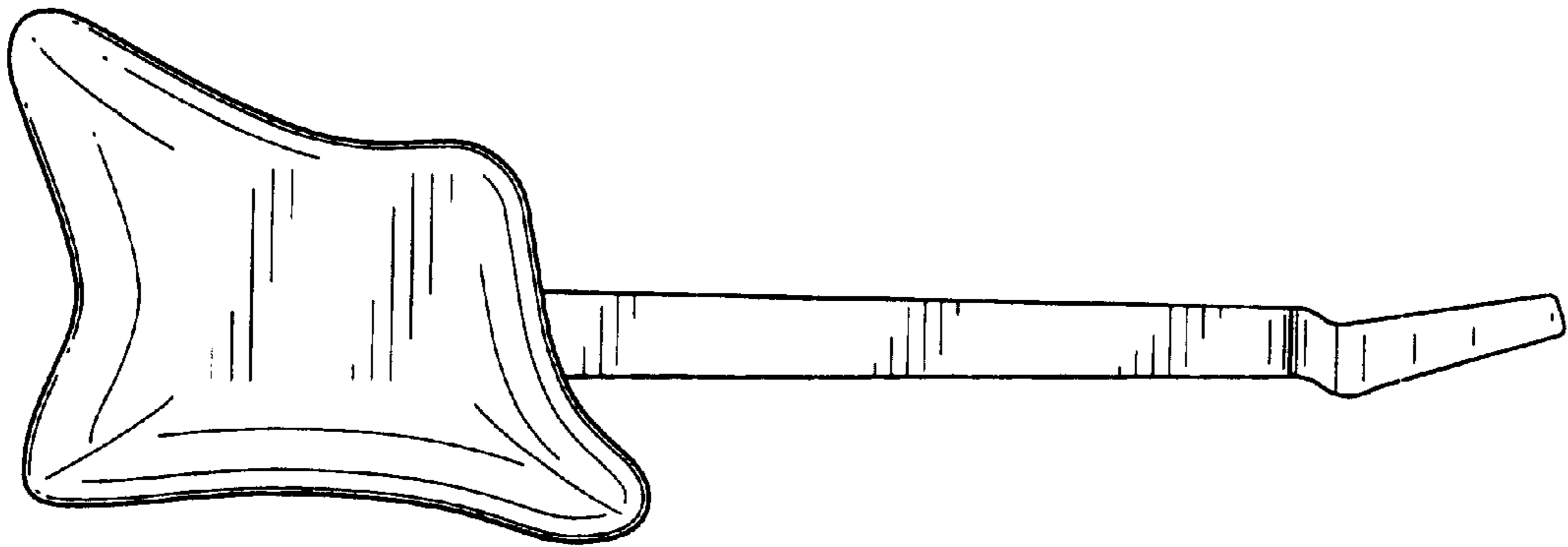

FIG. 5



FIG. 3

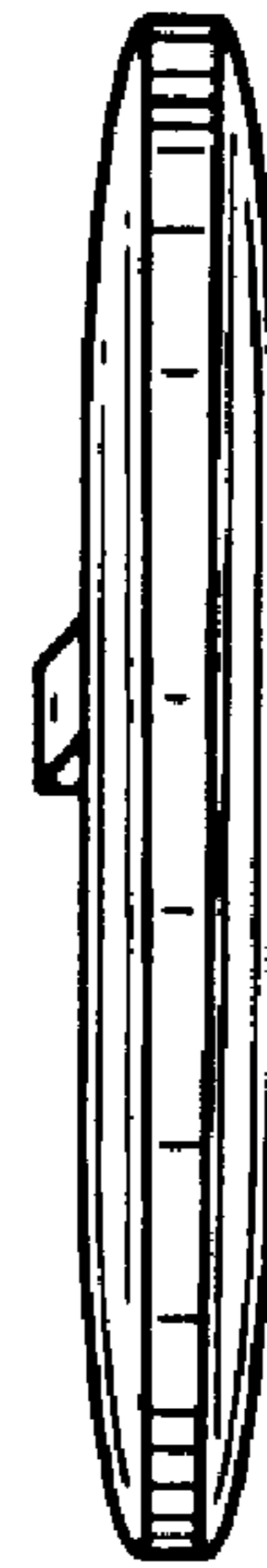

FIG. 4

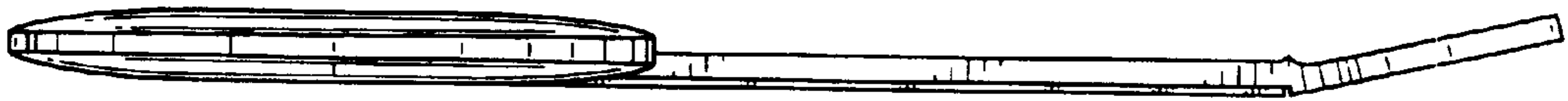

FIG. 6

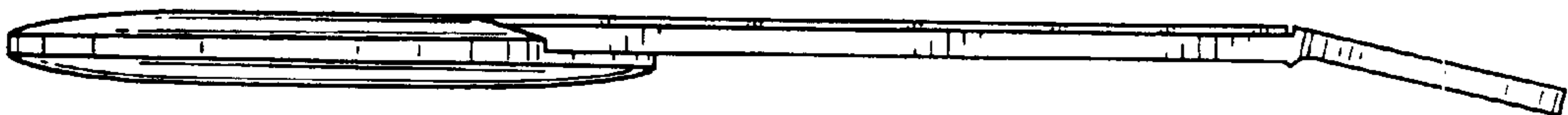

FIG. 7