



US00D461470S

(12) **United States Design Patent**
Kawa

(10) **Patent No.:** **US D461,470 S**

(45) **Date of Patent:** **** Aug. 13, 2002**

(54) **COMPUTER**

(75) Inventor: **Mitsuo Kawa**, Nara-ken (JP)

(73) Assignee: **Sharp Kabushiki Kaisha**, Osaka (JP)

(**) Term: **14 Years**

(21) Appl. No.: **29/150,103**

(22) Filed: **Nov. 6, 2001**

(30) **Foreign Application Priority Data**

May 16, 2001 (JP) 2001-013967

(51) **LOC (7) Cl.** **14-02**

(52) **U.S. Cl.** **D14/318**

(58) **Field of Search** D14/318, 319,
D14/321-323, 326, 327; D18/1, 2, 7; 235/145 A,
145 R; 341/22, 23; 345/104, 156, 168,
169, 173; 361/680-686; 400/486, 489

(56) **References Cited**

U.S. PATENT DOCUMENTS

D330,016 S	10/1992	Mizusugi et al.
D334,182 S	3/1993	Mizusugi et al.
D335,124 S	4/1993	Mizusugi et al.
D338,880 S	8/1993	Mizusugi et al.
D339,114 S	9/1993	Mizusugi et al.
D340,920 S	11/1993	Okuda et al.
D340,921 S	11/1993	Mizusugi et al.
D343,167 S	1/1994	Mizusugi et al.
D344,496 S	2/1994	Mizusugi et al.
D357,674 S	4/1995	Mizusugi
D384,043 S	9/1997	Tamaki
D385,856 S	11/1997	Kawa
D398,904 S	9/1998	Tamaki et al.
D405,434 S	2/1999	Mizuno
D411,181 S	6/1999	Tamaki et al.
D413,107 S	8/1999	Kawa et al.
D415,466 S	10/1999	Kawa

D419,535 S	1/2000	Tanimura
D421,972 S	3/2000	Makidera et al.
D425,874 S	5/2000	Tanimura
D426,835 S	6/2000	Tanimura
D434,031 S	* 11/2000	Koike et al. D14/318
D435,549 S	* 12/2000	Amano et al. D14/318
6,205,021 B1	* 3/2001	Klein et al. 345/167
D443,875 S	* 6/2001	Ma et al. D14/318
D444,462 S	7/2001	Tsuji

* cited by examiner

Primary Examiner—Freda Nunn

(74) *Attorney, Agent, or Firm*—Nixon & Vanderhye

(57) **CLAIM**

The ornamental design for a computer, as shown and described.

DESCRIPTION

FIG. 1 is a top, front and right side perspective view of a computer according to my design;
 FIG. 2 is a front elevational view thereof;
 FIG. 3 is a rear elevational view thereof;
 FIG. 4 is a top plan view thereof;
 FIG. 5 is a bottom plan view thereof;
 FIG. 6 is a right side elevational view thereof;
 FIG. 7 is a left side elevational view thereof;
 FIG. 8 is a top, front and right side perspective view thereof in a closed position;
 FIG. 9 is a bottom, rear and right side perspective view thereof;
 FIG. 10 is a front elevational view thereof;
 FIG. 11 is a rear elevational view thereof;
 FIG. 12 is a top plan view thereof;
 FIG. 13 is a bottom plan view thereof;
 FIG. 14 is a right side elevational view thereof; and,
 FIG. 15 is a left side elevational view thereof.

1 Claim, 13 Drawing Sheets

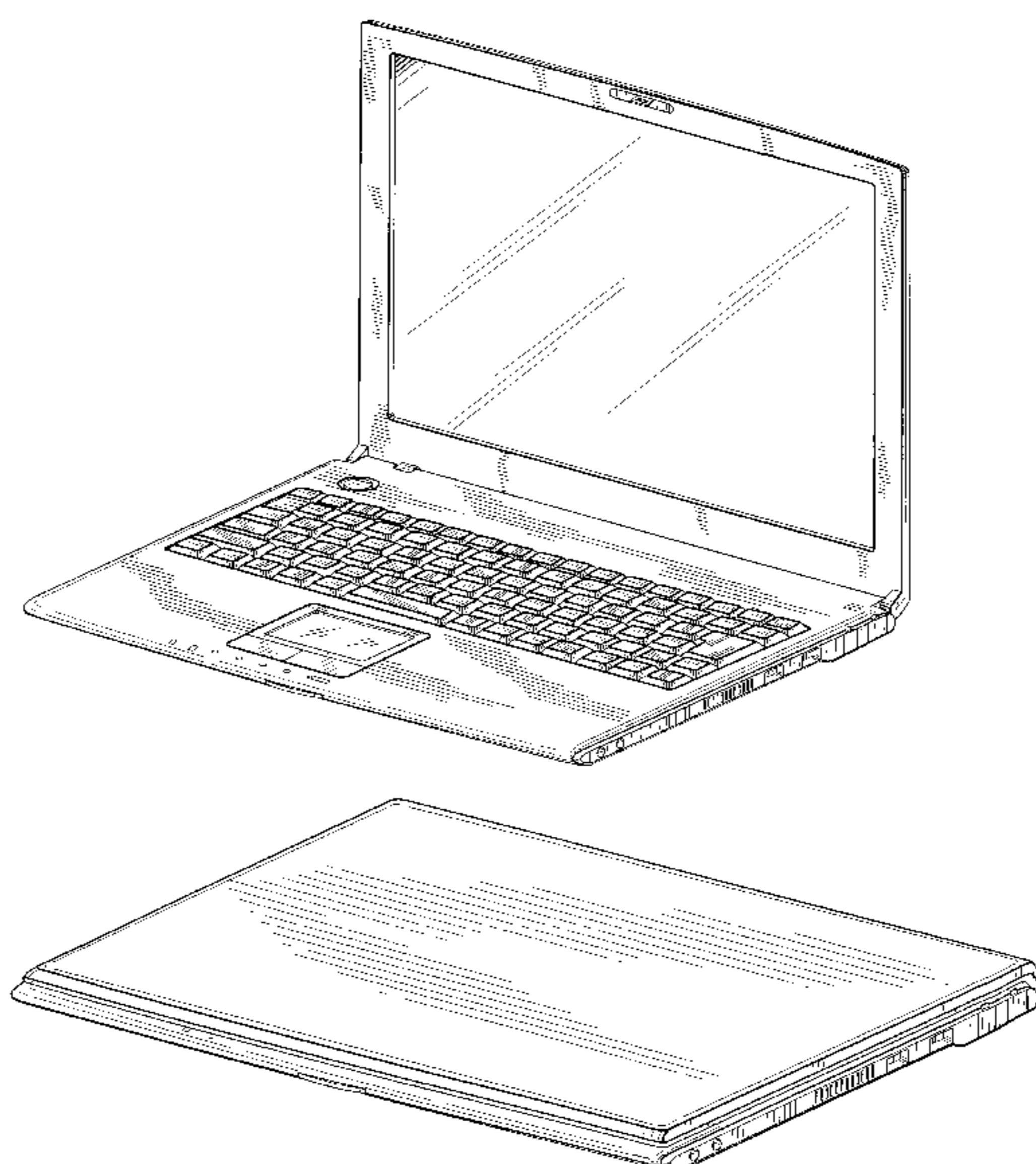

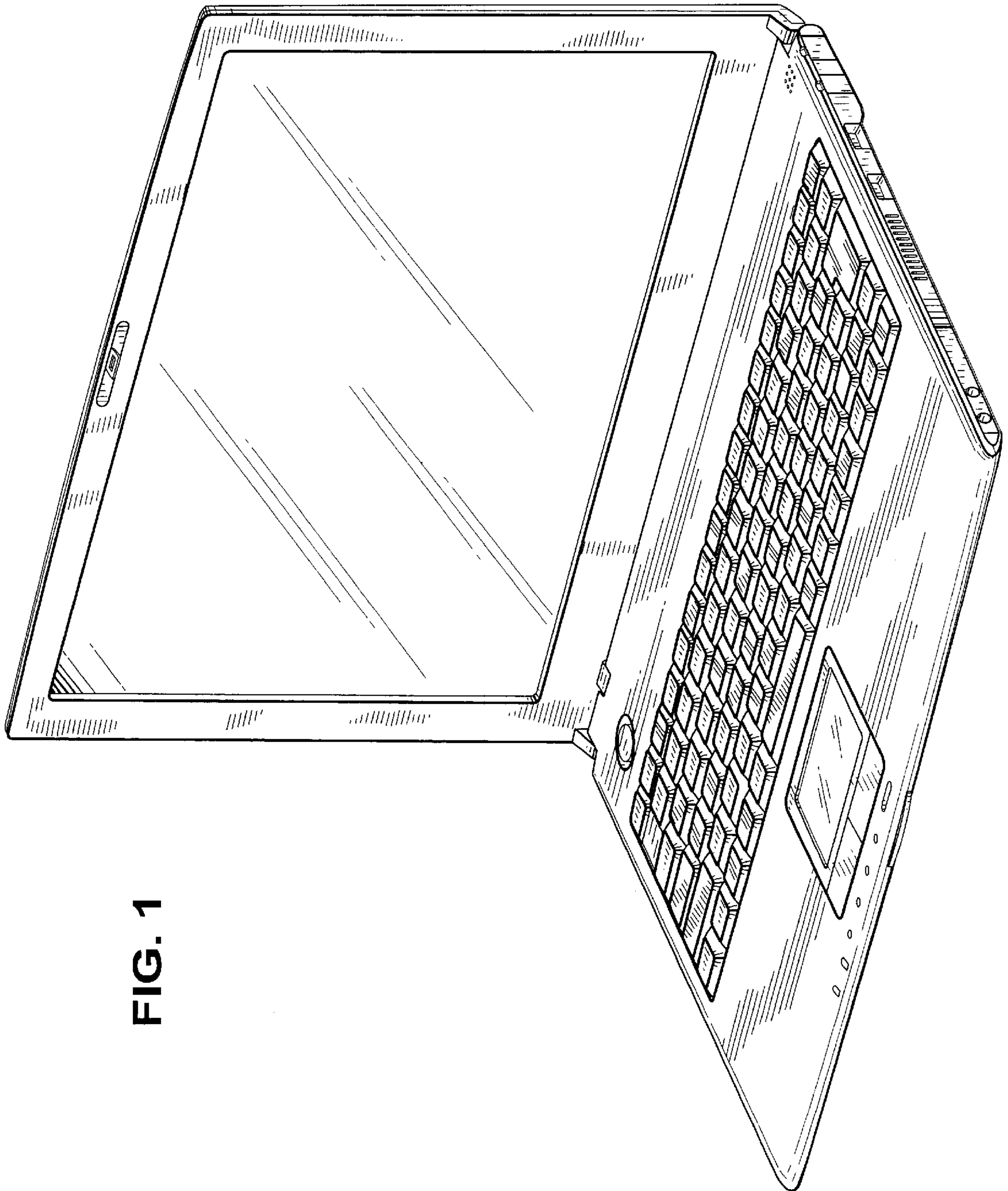

FIG. 1

FIG. 2

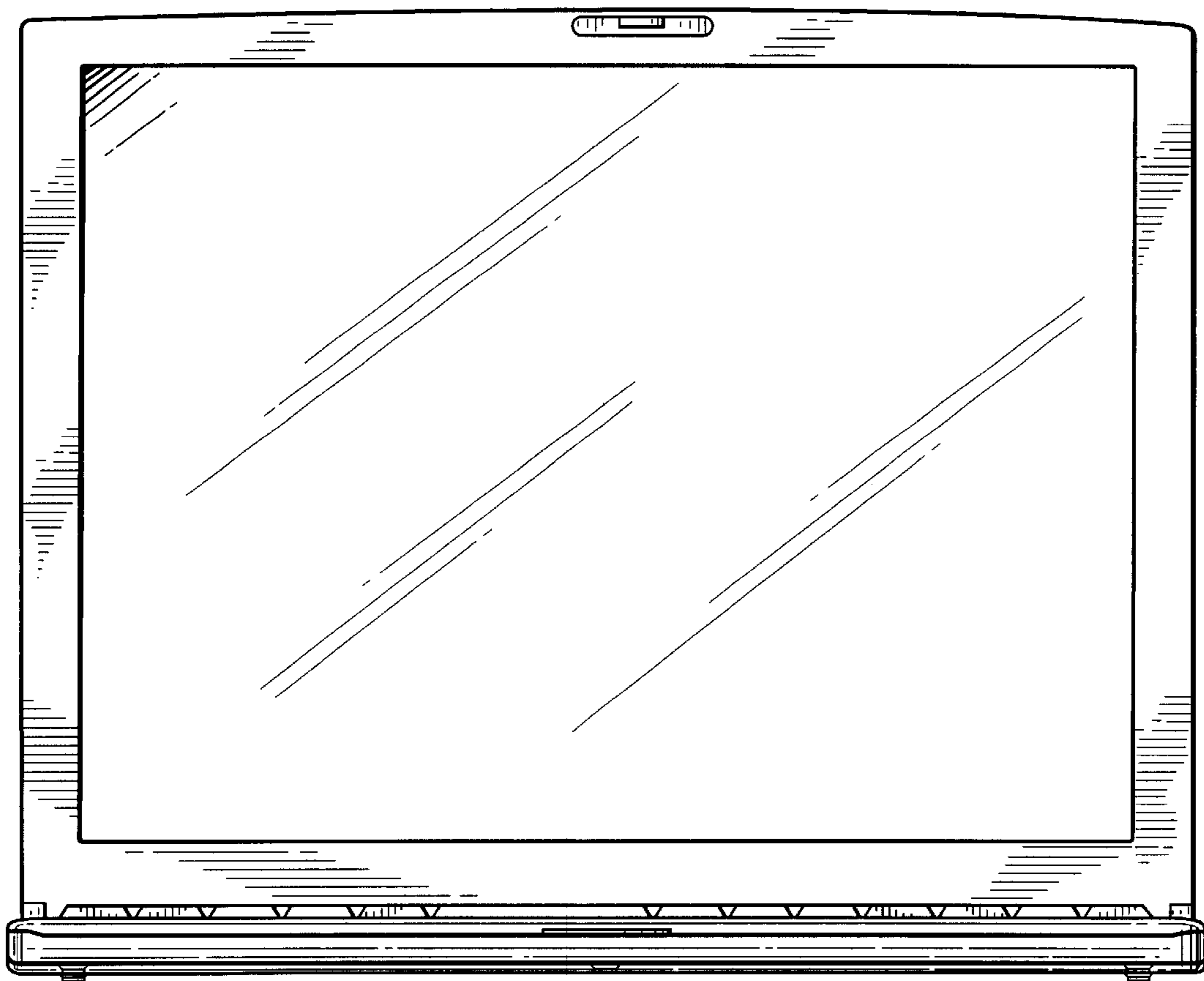

FIG. 3

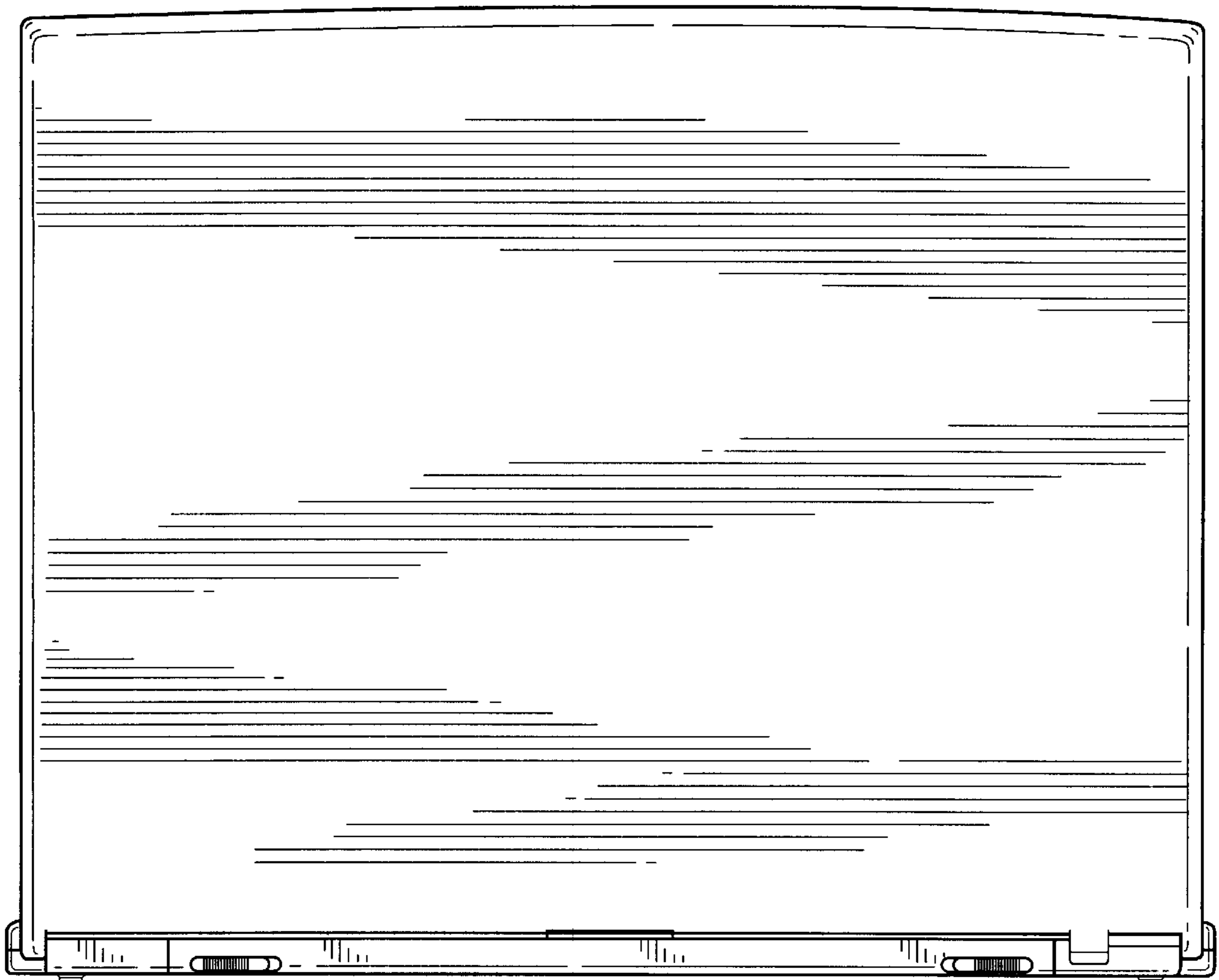

FIG. 4

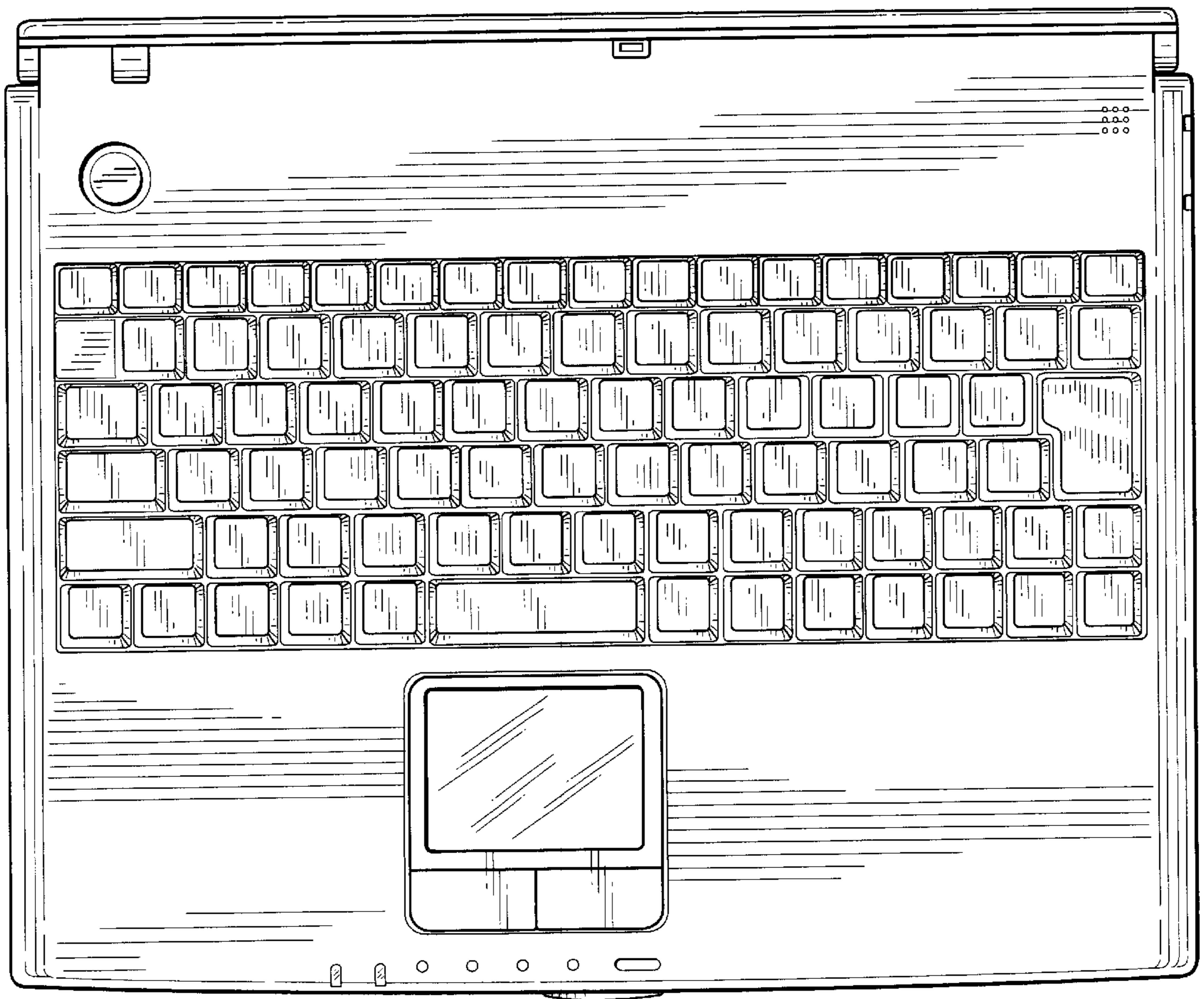
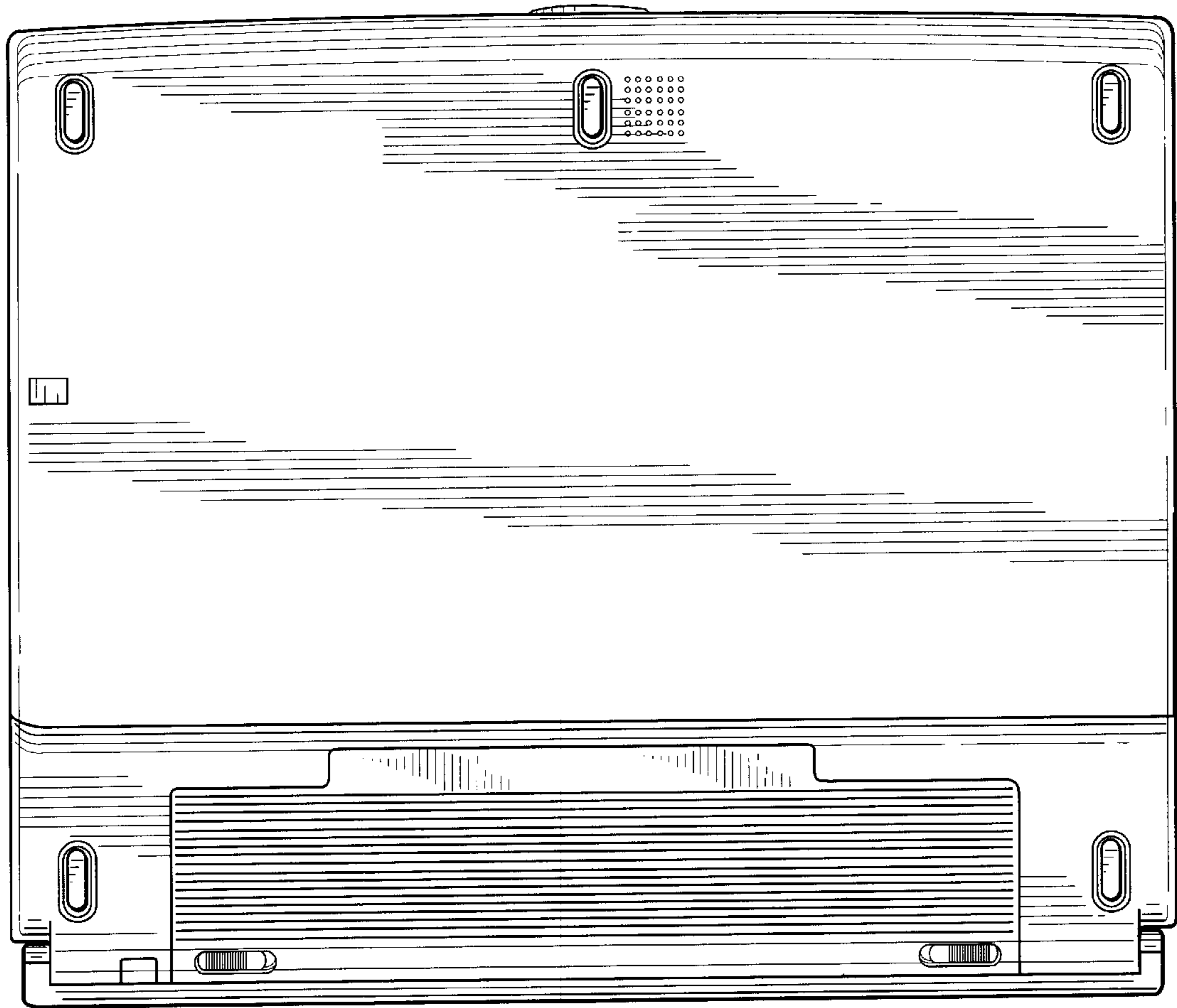

FIG. 5



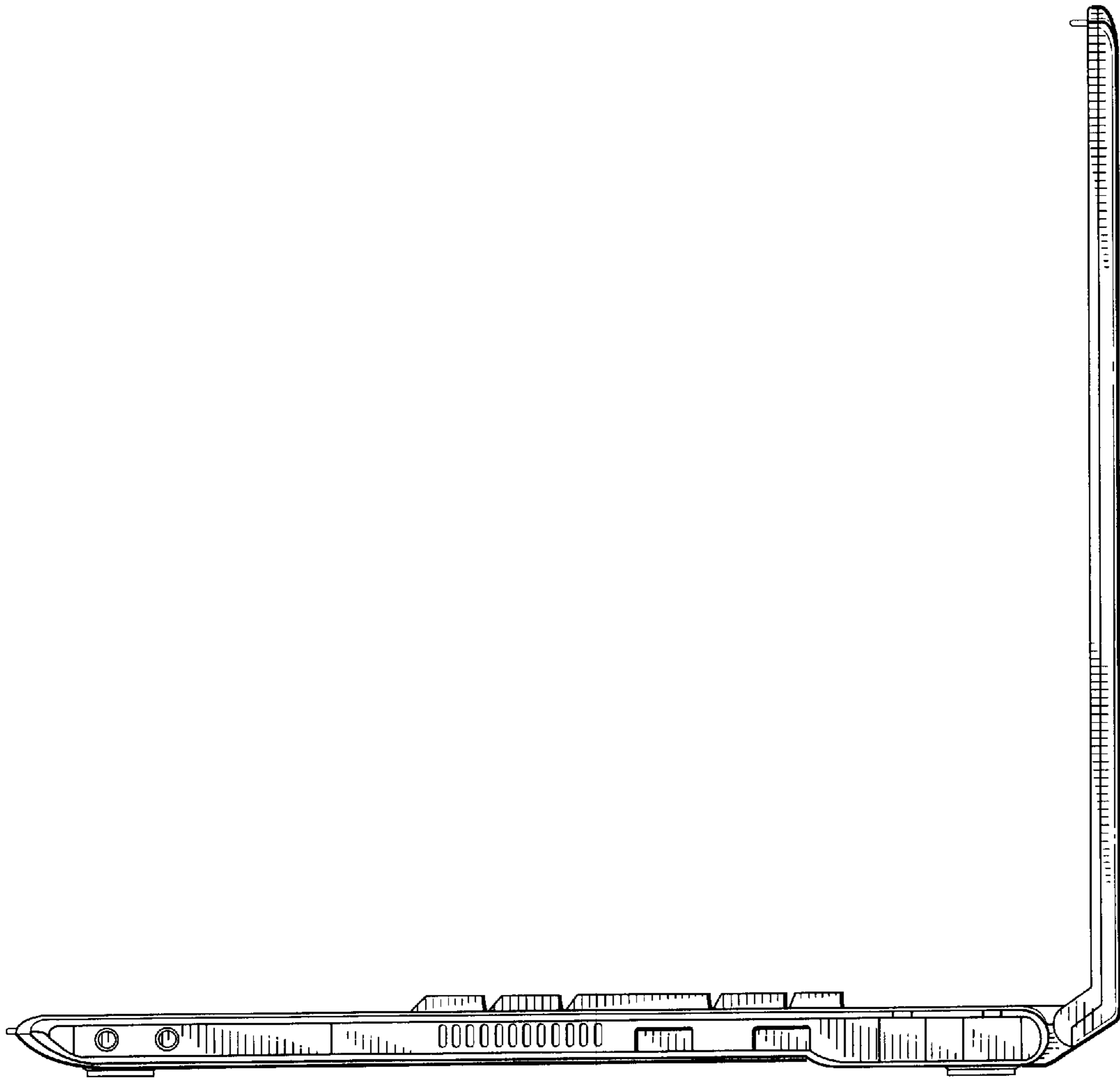

FIG. 6

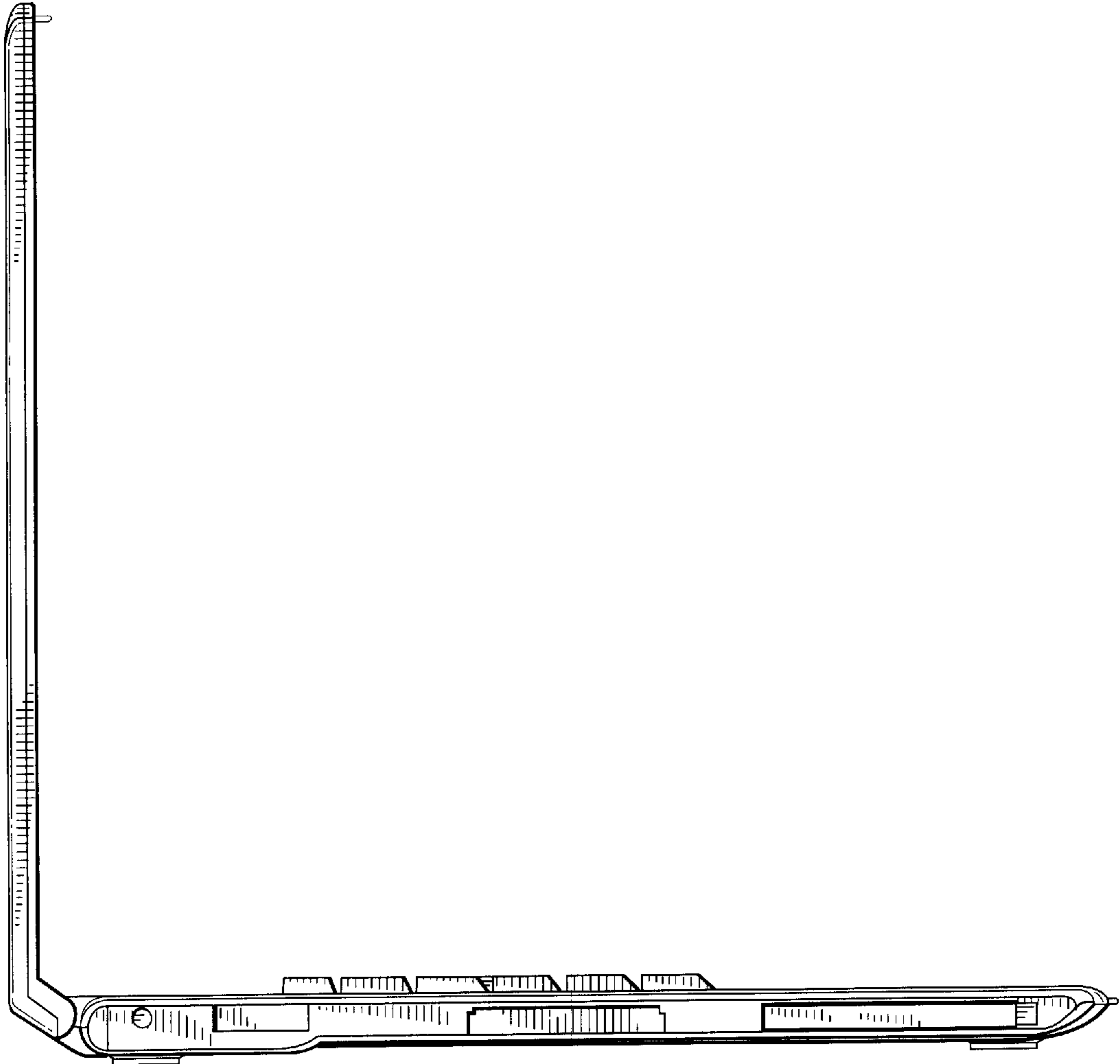
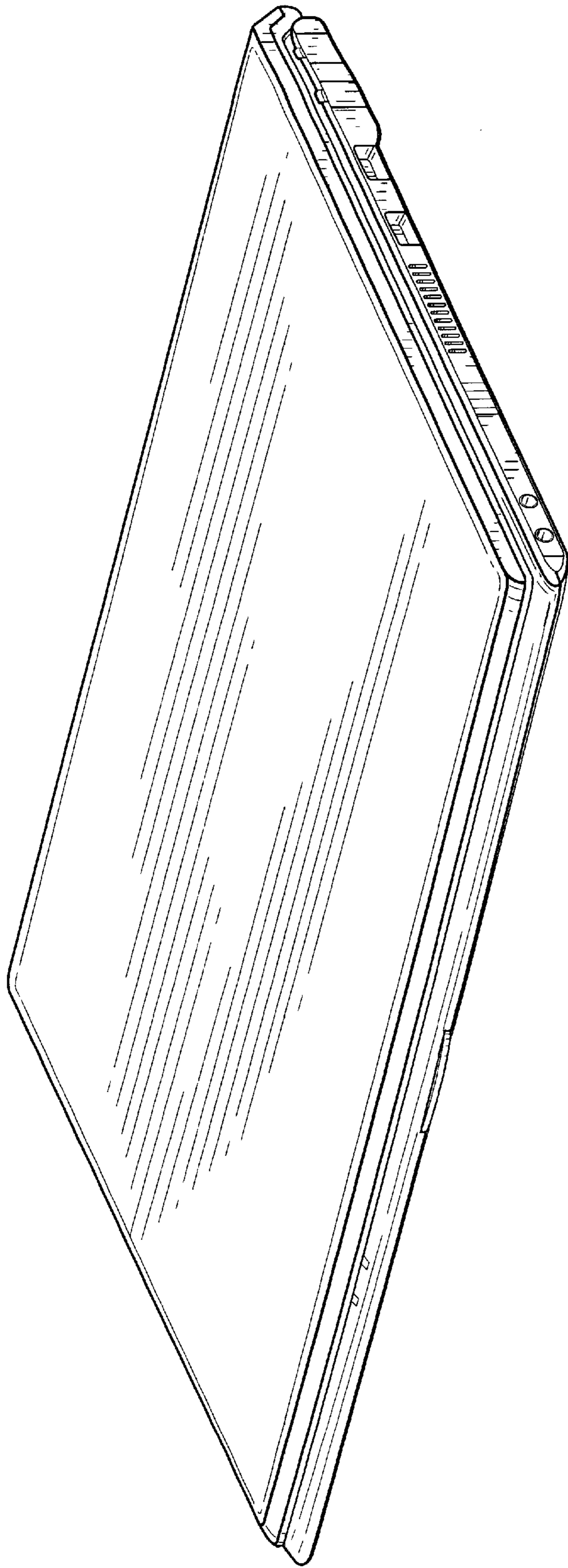

FIG. 7

FIG. 8



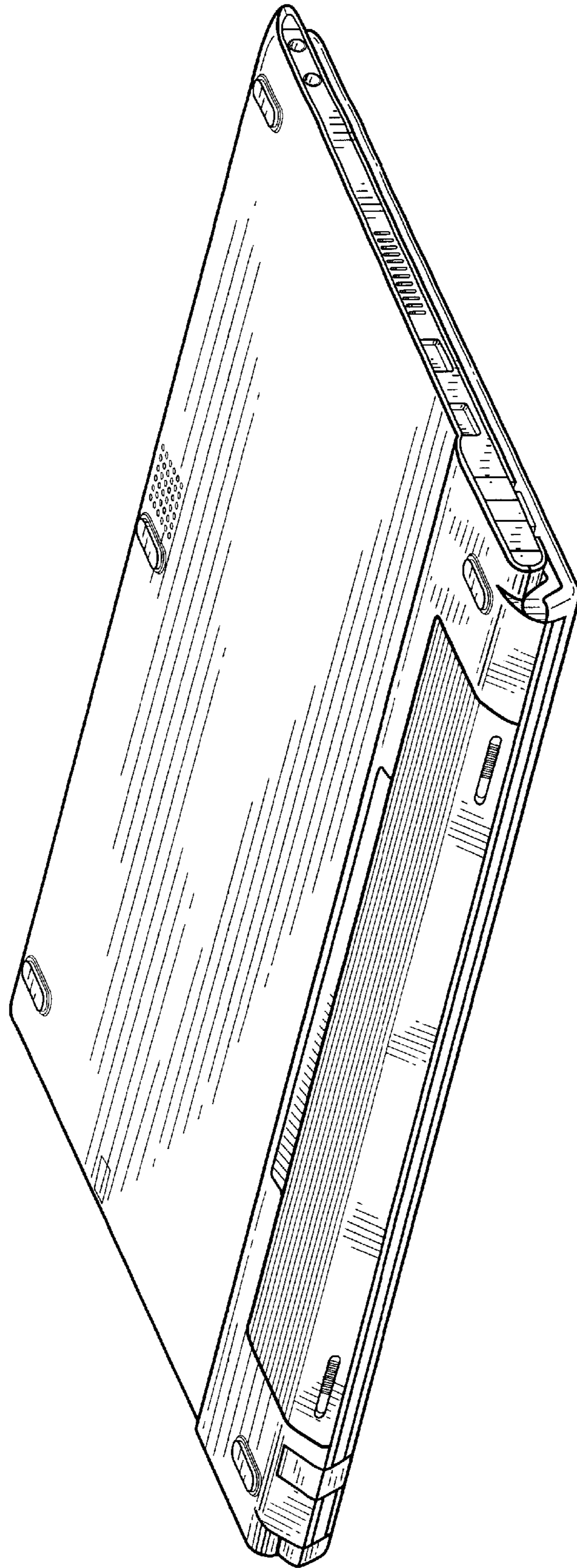

FIG. 9

FIG. 10

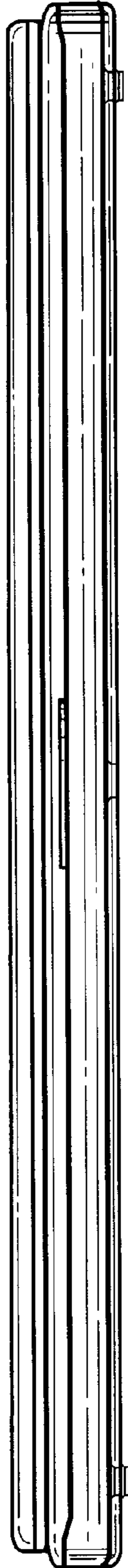

FIG. 11

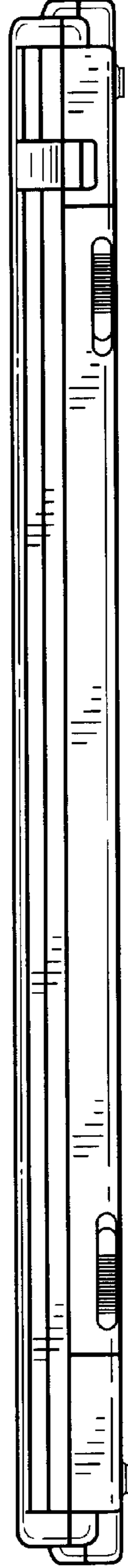

FIG. 12

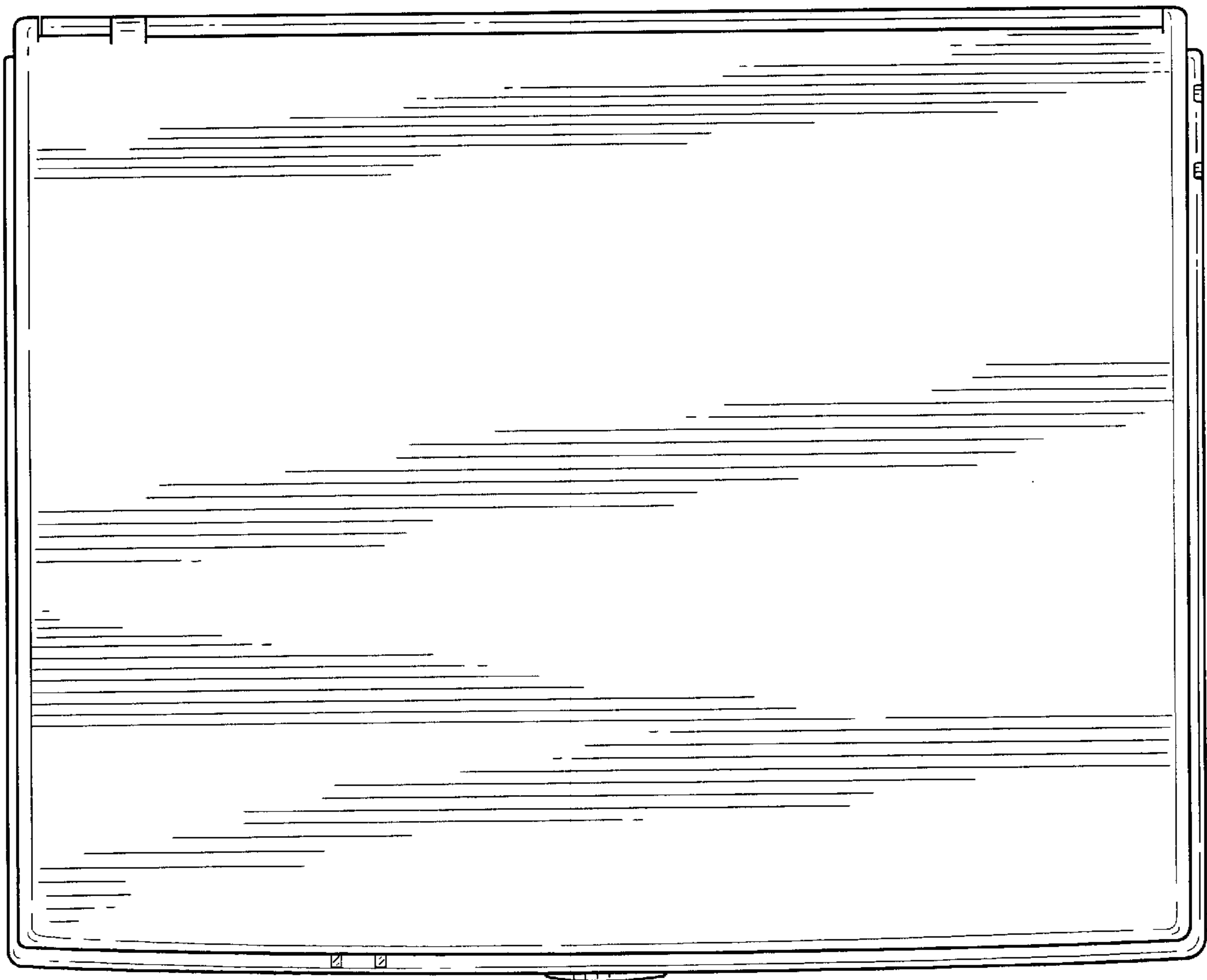

FIG. 13

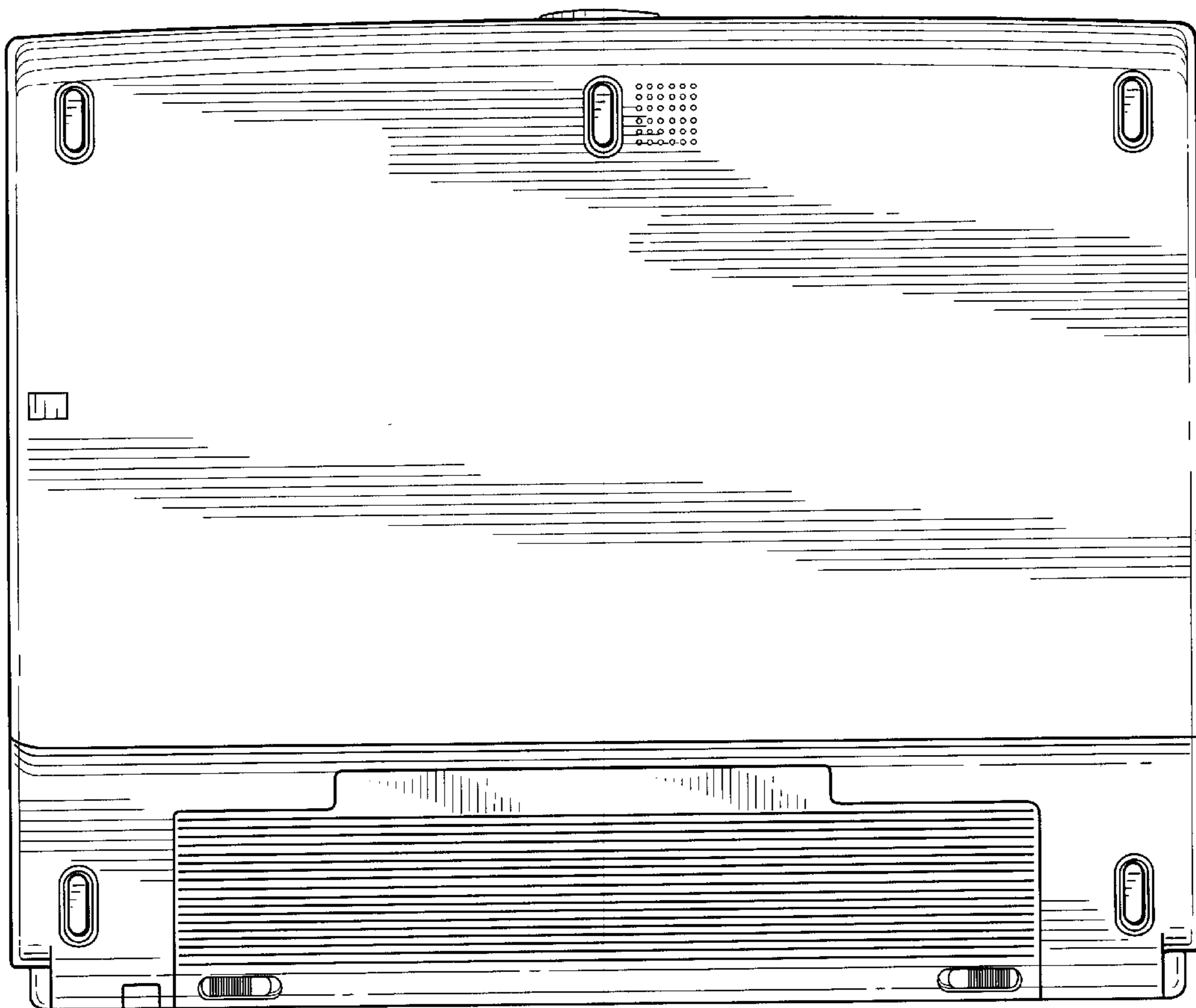

FIG. 14

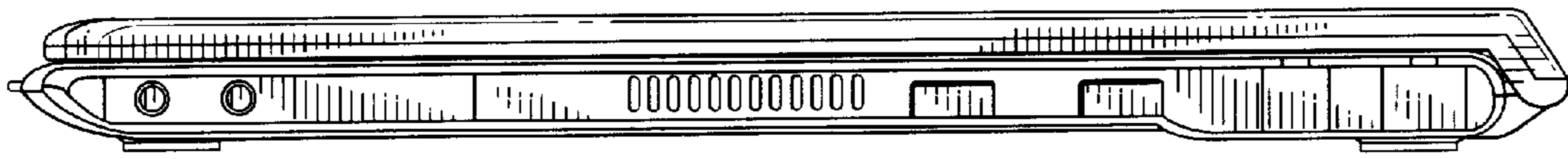

FIG. 15

