



US00D461376S

(12) **United States Design Patent**  
**Bodum**

(10) **Patent No.:** **US D461,376 S**

(45) **Date of Patent:** **\*\* Aug. 13, 2002**

(54) **SPICE GRINDER**

(75) **Inventor:** **Jorgen Bodum, St. Niklausen (CH)**

(73) **Assignee:** **PI-Design AG, Triengen (CH)**

(\*\*) **Term:** **14 Years**

(21) **Appl. No.:** **29/148,648**

(22) **Filed:** **Sep. 26, 2001**

(30) **Foreign Application Priority Data**

Apr. 3, 2001 (DK) ..... MA 2001 00352

(51) **LOC (7) Cl.** ..... **07-04**

(52) **U.S. Cl.** ..... **D7/679**

(58) **Field of Search** ..... D7/679, 372, 373,  
D7/591-597; 222/142.1-142.9, 480; 241/168,  
169, 169.1, 262, 286

(56) **References Cited**

**U.S. PATENT DOCUMENTS**

D155,428 S \* 10/1949 Isrin ..... D7/679

3,991,947 A \* 11/1976 Schlessel ..... 241/169.1  
5,156,084 A \* 10/1992 Lin ..... 241/169.1 X  
D397,919 S \* 9/1998 Chiu ..... D7/679

\* cited by examiner

*Primary Examiner*—Terry A. Wallace

(74) *Attorney, Agent, or Firm*—Nath & Associates PLLC;  
Gary M. Nath; Marvin C. Berkowitz

(57) **CLAIM**

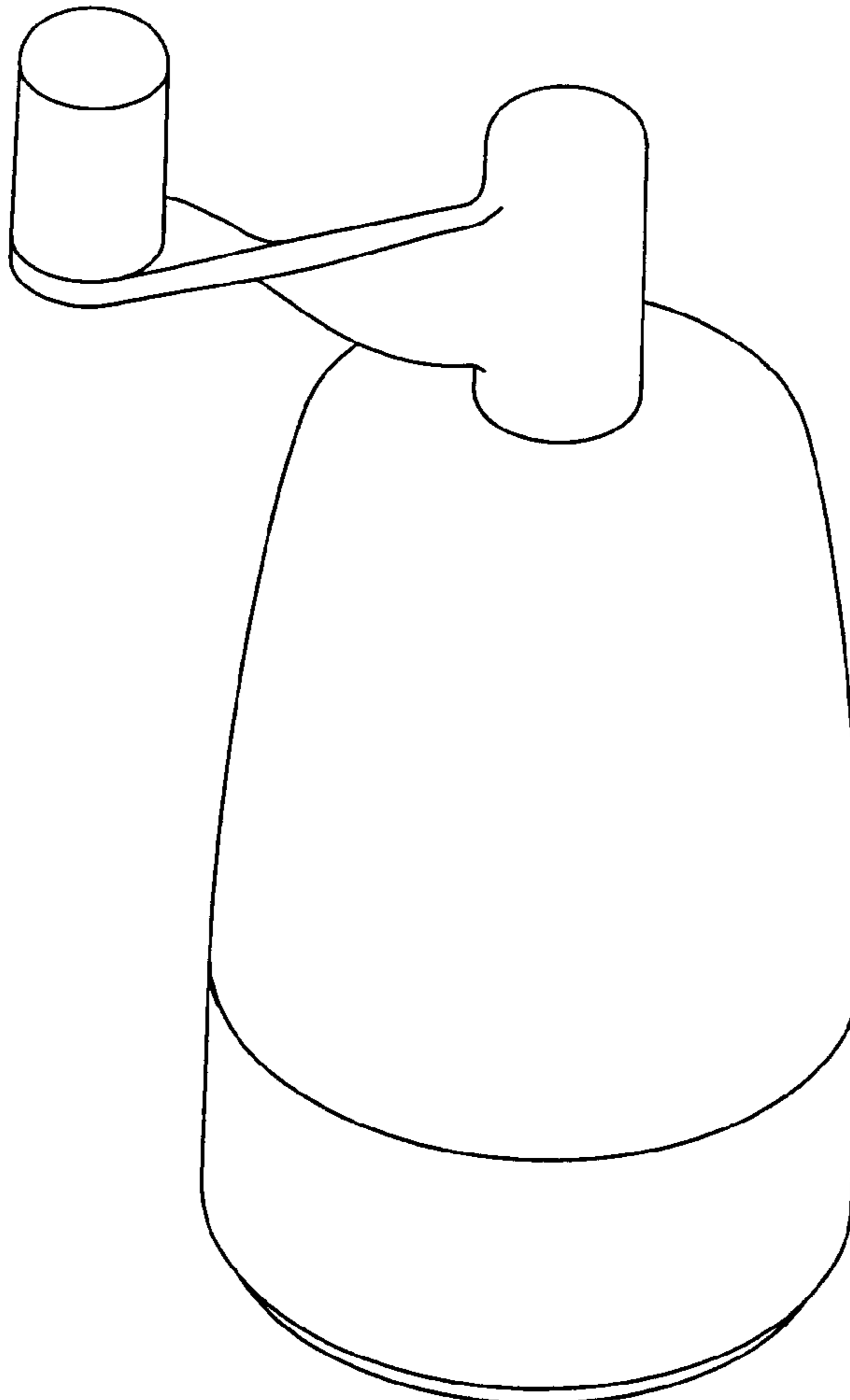
The ornamental design for a spice grinder, as shown and described.

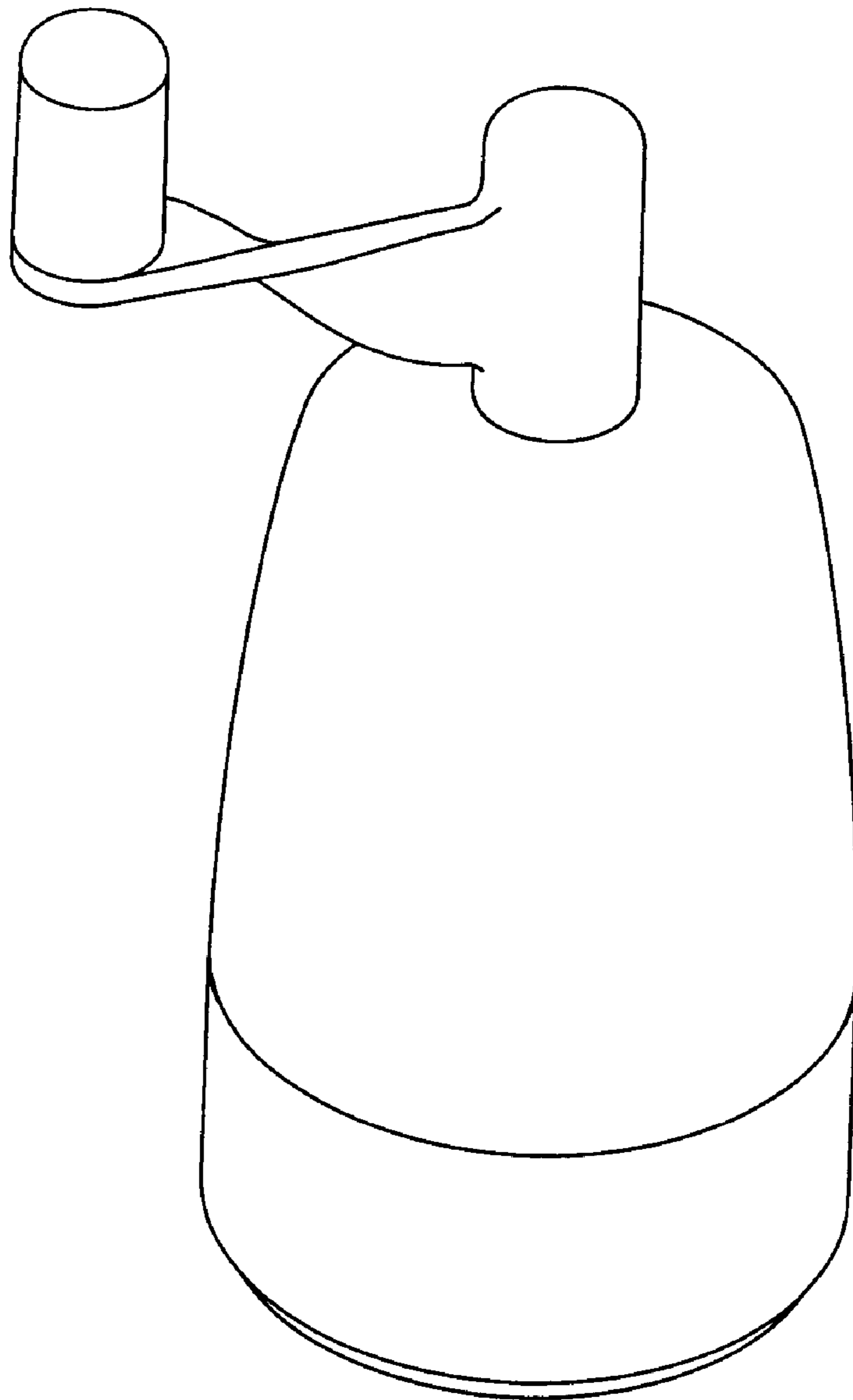
**DESCRIPTION**

FIG. 1 is an oblique perspective view of the spice grinder; FIG. 2 is a right side view of the spice grinder, as shown in FIG. 1;

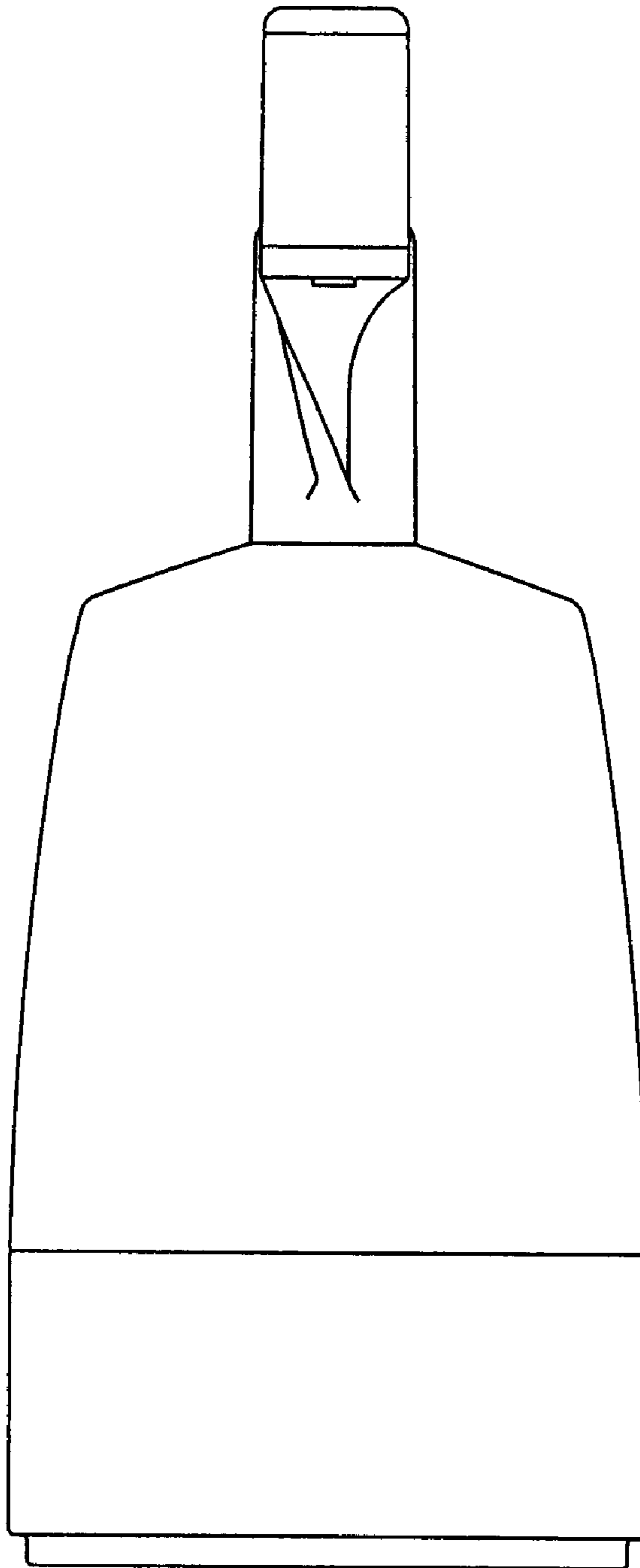
FIG. 3 is a left side view of the spice grinder; FIG. 4 is a front side view of the spice grinder; FIG. 5 is a back side view of the spice grinder; FIG. 6 is a top view of the spice grinder; and, FIG. 7 is a bottom view of the spice grinder.

**1 Claim, 7 Drawing Sheets**

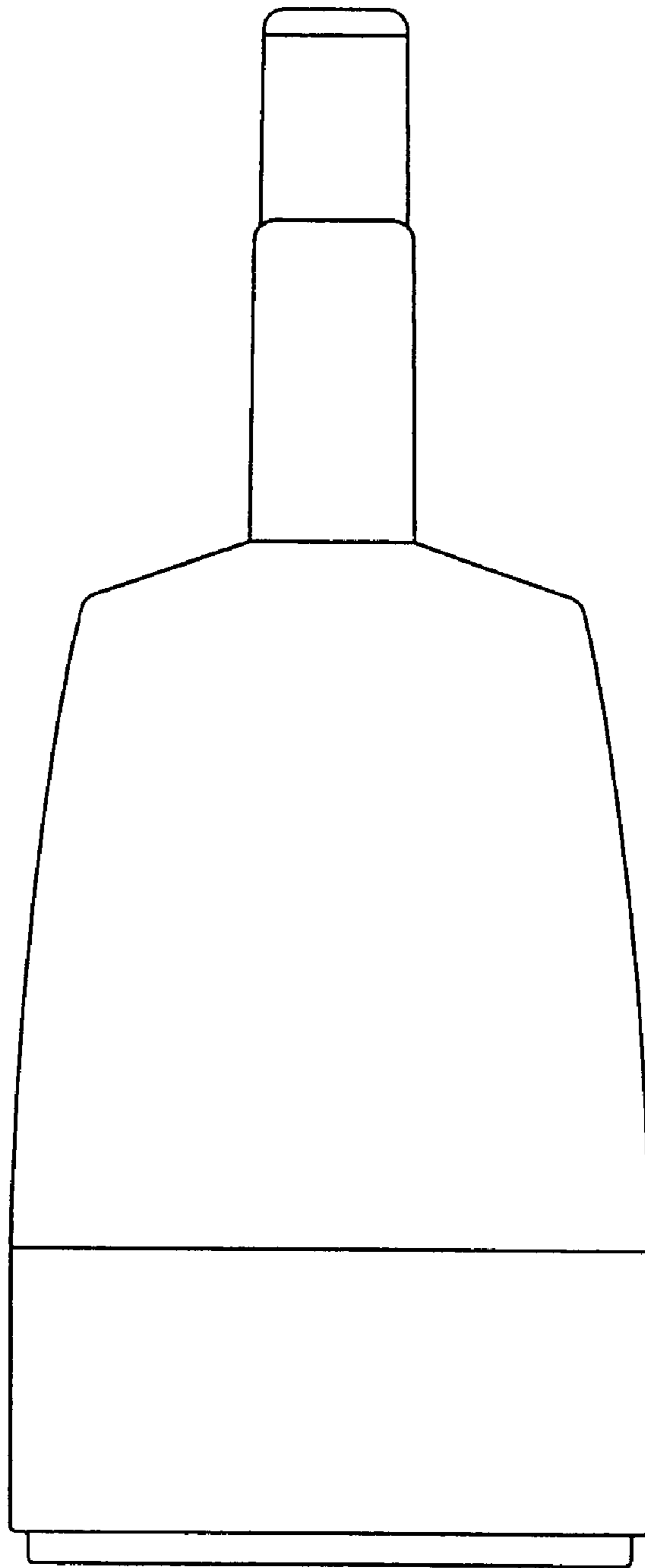




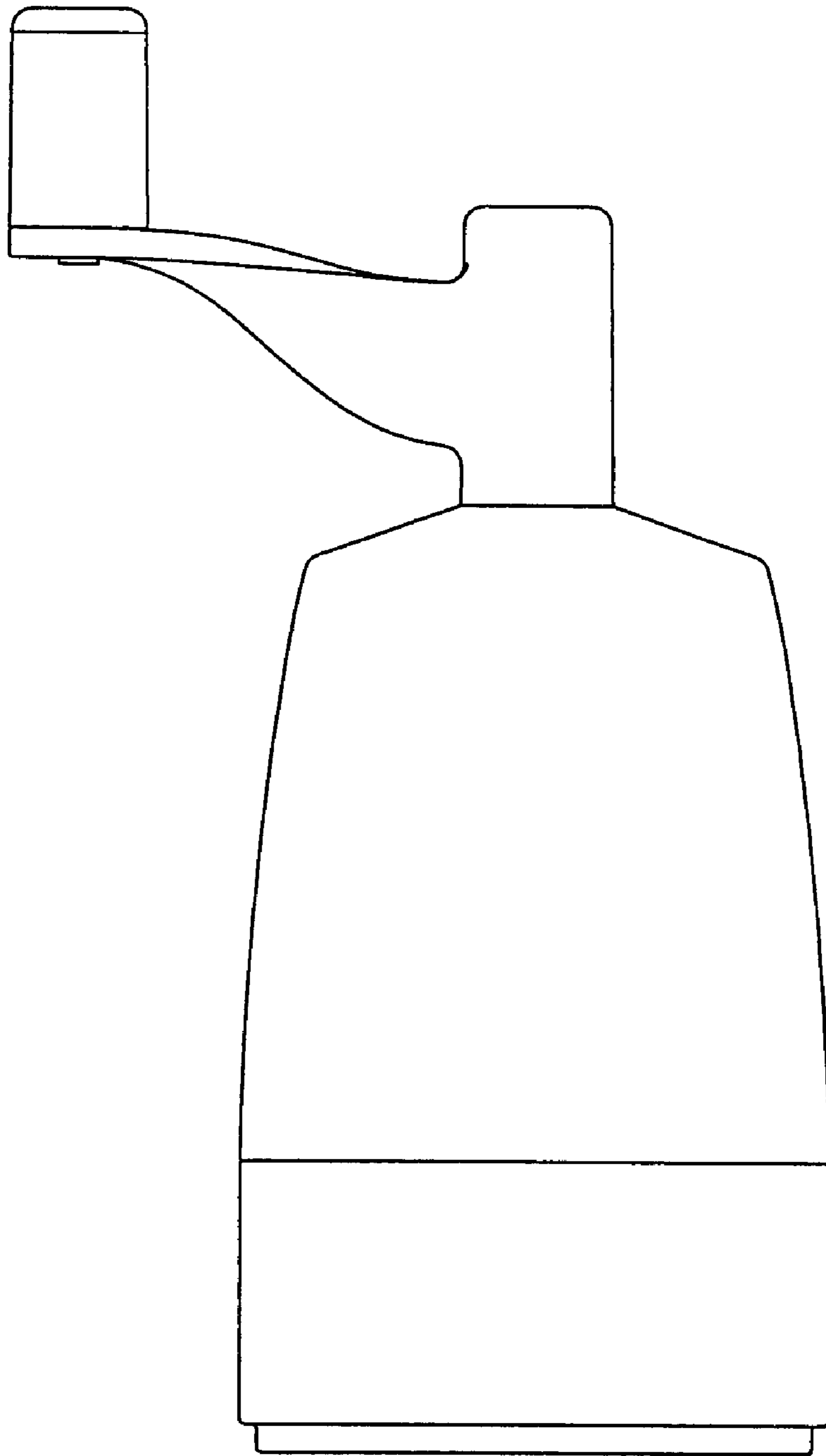
**Fig. 1**



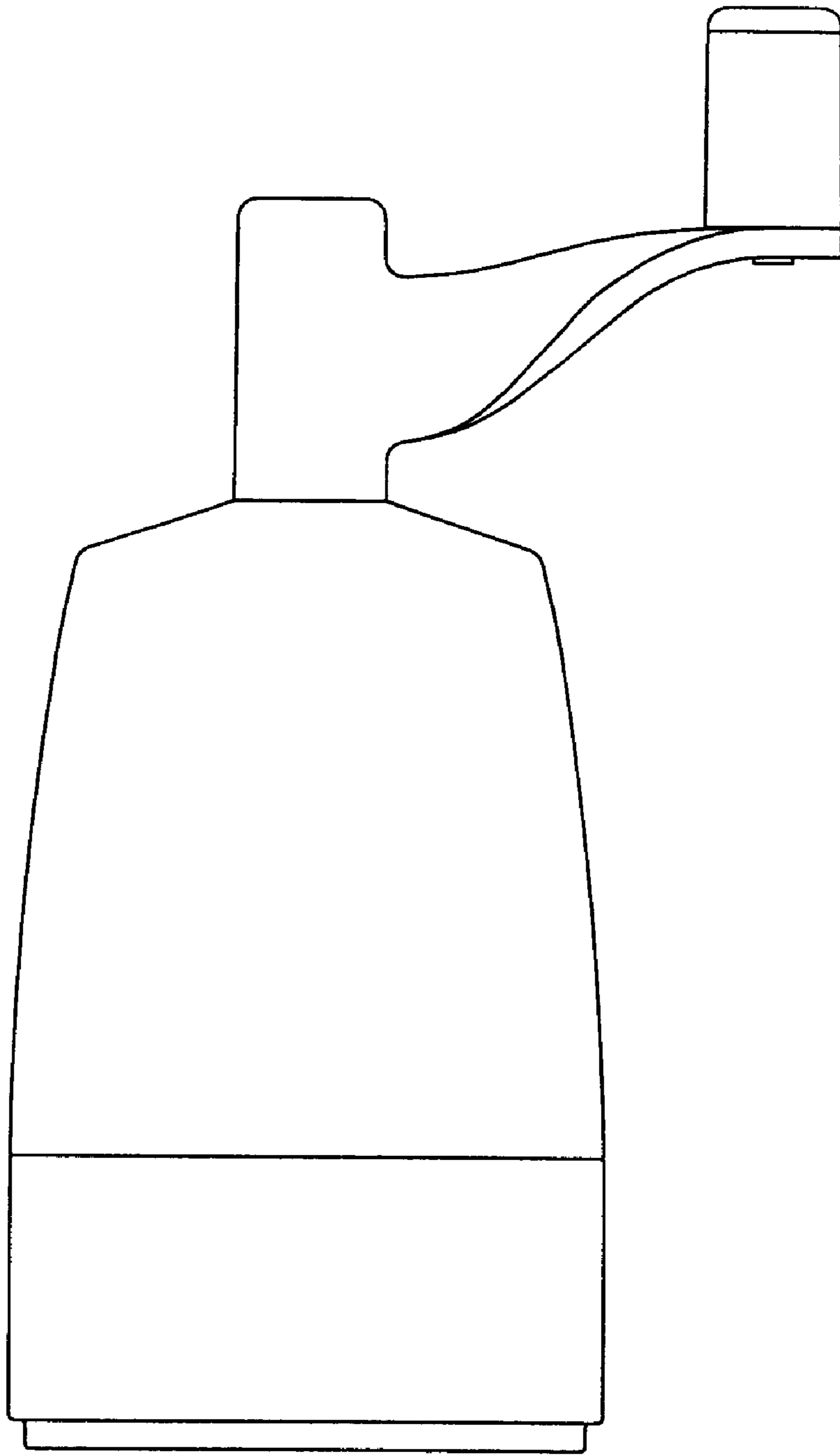
**Fig. 2**



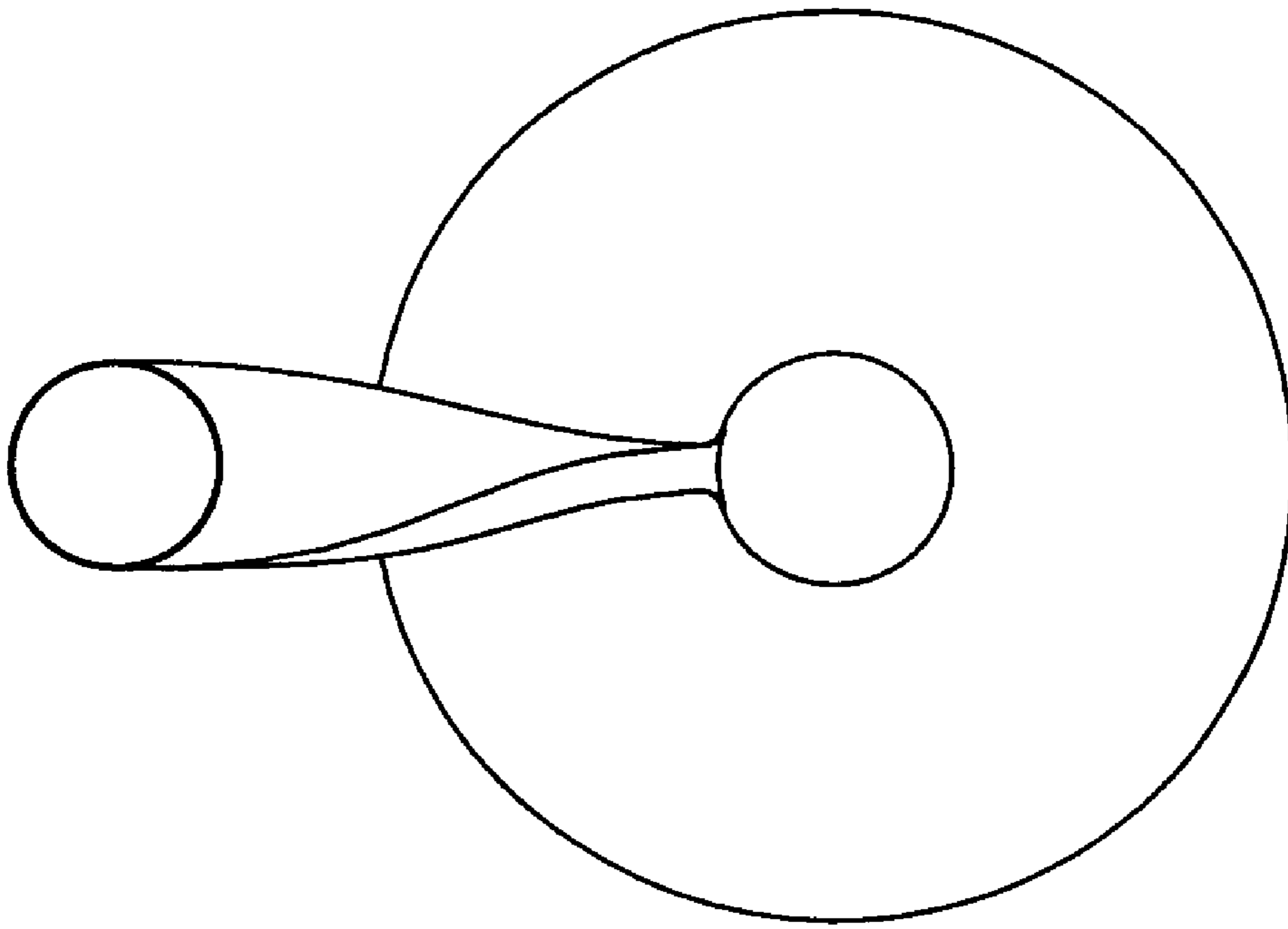
**Fig. 3**



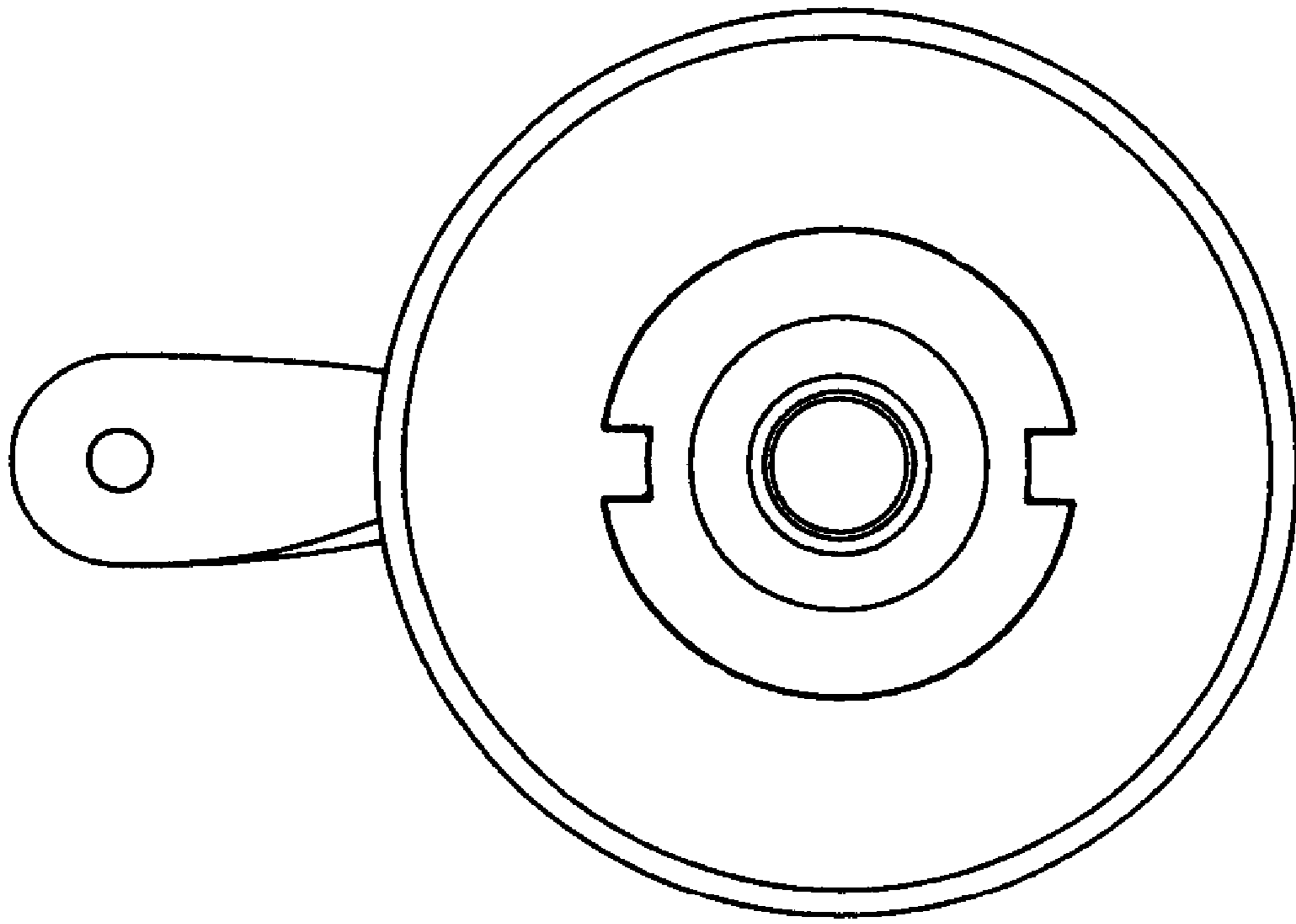
**Fig. 4**



**Fig. 5**



**Fig. 6**



**Fig. 7**