

US00D461369S

(12) **United States Design Patent**  
**Sims et al.**

(10) **Patent No.:** **US D461,369 S**

(45) **Date of Patent:** **\*\* Aug. 13, 2002**

(54) **CUP**  
(75) **Inventors:** **Bruce J. Sims**, Leewood, KS (US);  
**Jeffrey A. Mann; Scott L. Fisher**, both  
of Evansville, IN (US)

D405,319 S 2/1999 Jarvis ..... D7/531  
6,047,849 A 4/2000 Schwegman et al.  
D428,307 S 7/2000 Yeandel ..... D7/531  
D436,499 S \* 1/2001 Pritchard et al. .... D7/530  
D446,687 S \* 8/2001 Furman et al. .... D7/523

(73) **Assignee:** **Berry Plastics Corporation**,  
Evansville, IN (US)

(\*\*) **Term:** **14 Years**

(21) **Appl. No.:** **29/139,593**

(22) **Filed:** **Apr. 3, 2001**

(51) **LOC (7) Cl.** ..... **07-01**

(52) **U.S. Cl.** ..... **D7/531; D7/523; D7/509**

(58) **Field of Search** ..... D7/531, 523, 509,  
D7/507, 532; 220/737, 675, 771, 669, 592.1;  
229/400, 404, 118; 215/382, 12.1; 206/217

**OTHER PUBLICATIONS**

Photocopy of a prior art cup (sheet 1—side view, sheet 2 top view and sheet 3 bottom view). Date of publication unknown.

\* cited by examiner

*Primary Examiner*—M. N. Pandozzi

(74) *Attorney, Agent, or Firm*—Barnes & Thornburg

(57) **CLAIM**

The ornamental design for a cup, as shown and described.

**DESCRIPTION**

FIG. 1 is a front view of a cup showing our new design;  
FIG. 2 is a top view of the cup of FIG. 1;  
FIG. 3 is a bottom view of the cup of FIG. 1;  
FIG. 4 is a sectional view of the cup of FIG. 1 taken along line 4—4 of FIG. 1;  
FIG. 5 is a front view of a second embodiment of a cup showing our new design;  
FIG. 6 is a top view of the cup of FIG. 5;  
FIG. 7 is a bottom view of the cup of FIG. 5;  
FIG. 8 is a sectional view of the cup of FIG. 5 taken along line 8—8 of FIG. 5;  
FIG. 9 is a front view of a third embodiment of a cup showing our new design;  
FIG. 10 is a top view of the cup of FIG. 9;  
FIG. 11 is a bottom view of the cup of FIG. 9; and,  
FIG. 12 is a sectional view of the cup of FIG. 9 taken along line 12—12 of FIG. 9.

(56) **References Cited**

**U.S. PATENT DOCUMENTS**

D46,619 S 11/1914 Fisher  
D47,527 S \* 6/1915 Sanford ..... D7/531  
D47,721 S 8/1915 Haley  
D81,984 S \* 9/1930 Kirkpatrick ..... D7/531  
2,142,811 A 1/1939 Agonis  
3,123,273 A \* 3/1964 Miller ..... 229/400  
3,288,340 A 11/1966 Shapiro et al.  
4,039,435 A \* 8/1977 Narva ..... 206/217  
5,025,981 A \* 6/1991 Schellenberg ..... 229/118  
5,427,269 A 6/1995 Willbrandt  
5,433,337 A 7/1995 Willbrandt  
D362,368 S 9/1995 Willbrandt  
D370,389 S 6/1996 Wilson  
D379,738 S 6/1997 Liming et al.  
D381,558 S \* 7/1997 Schaefer et al. .... D7/531  
5,657,897 A 8/1997 Schwartzburg  
D383,038 S 9/1997 Willbrandt  
D402,505 S 12/1998 Jarvis

**1 Claim, 3 Drawing Sheets**

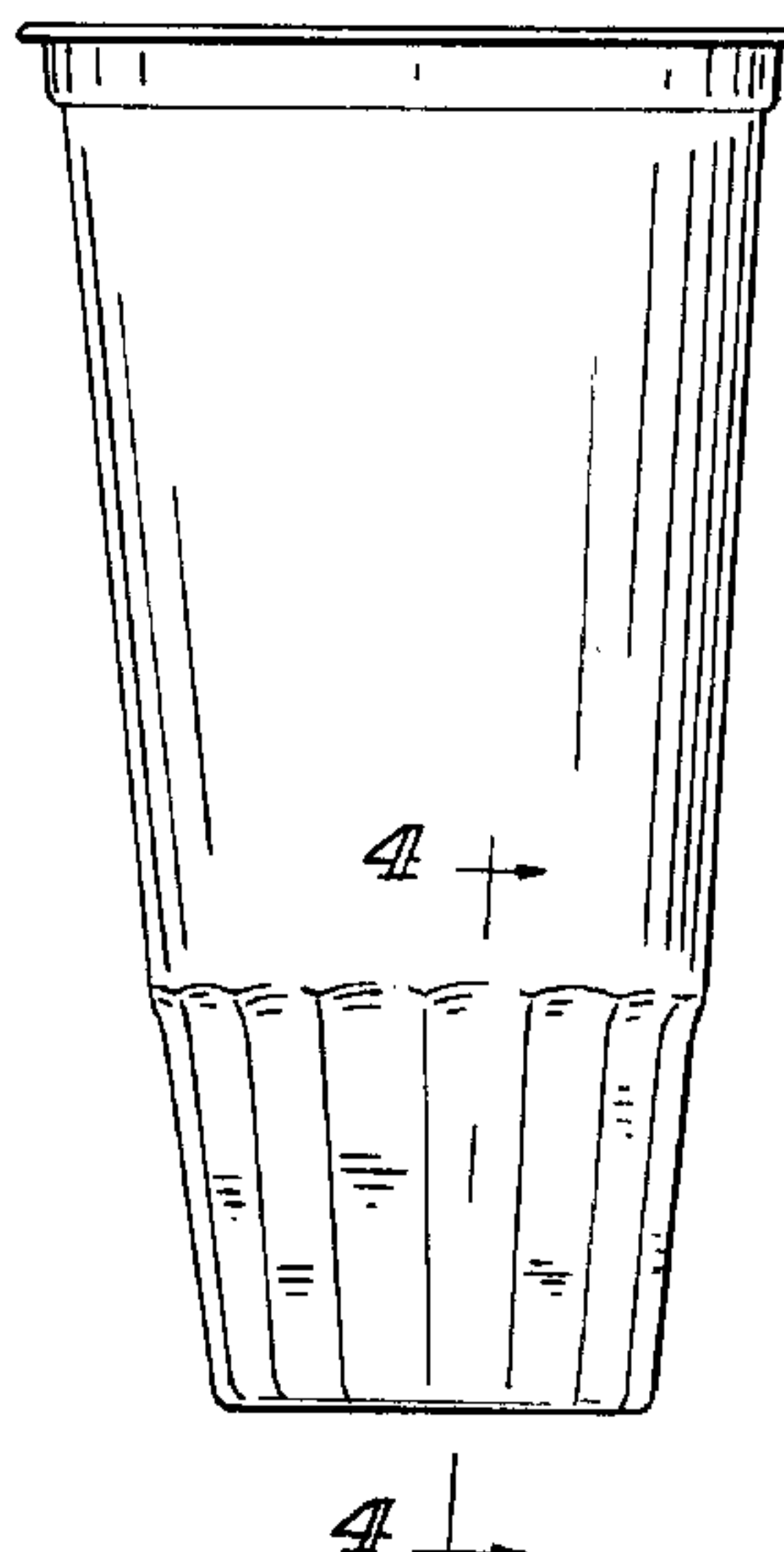

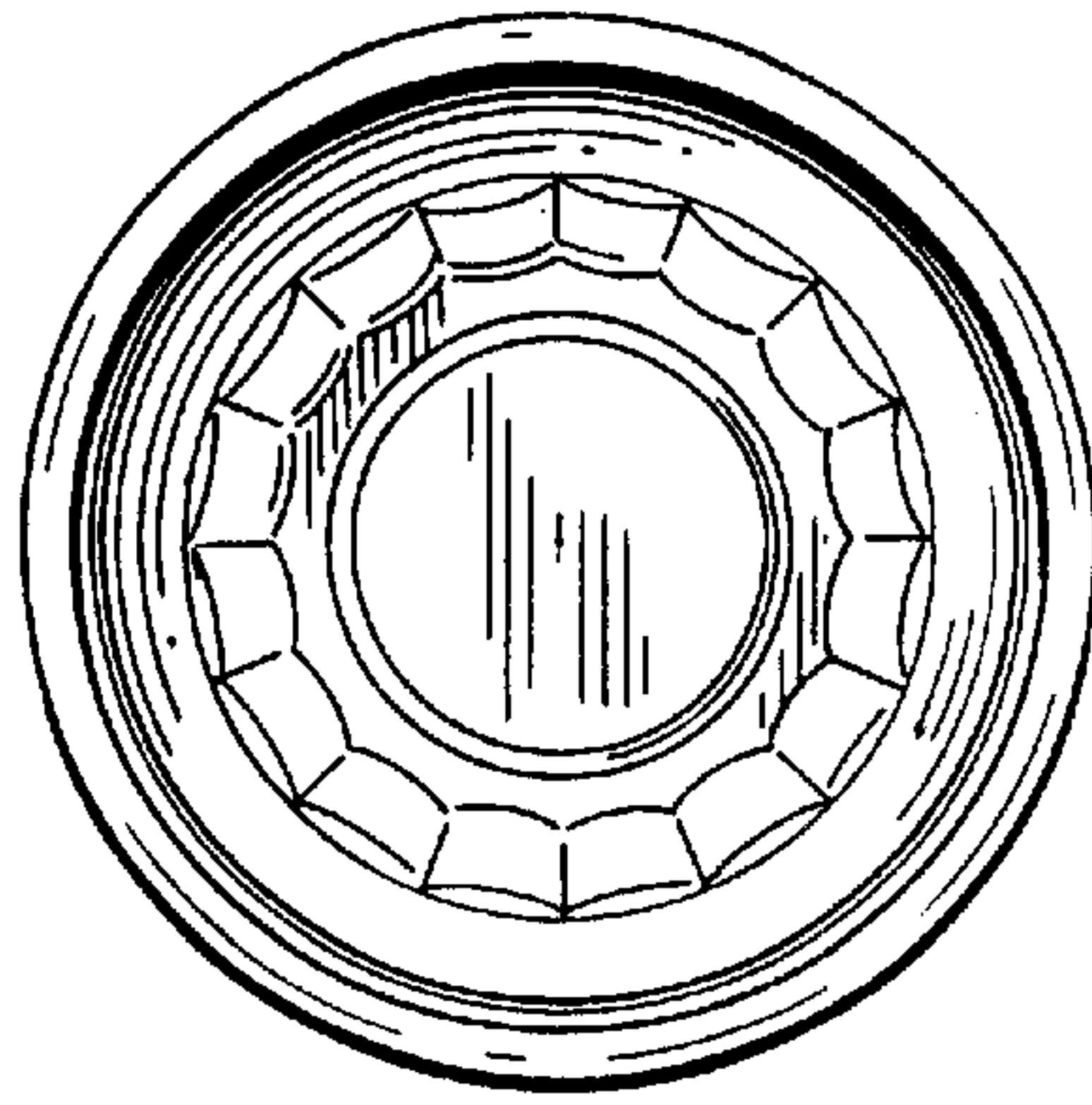

FIG. 2

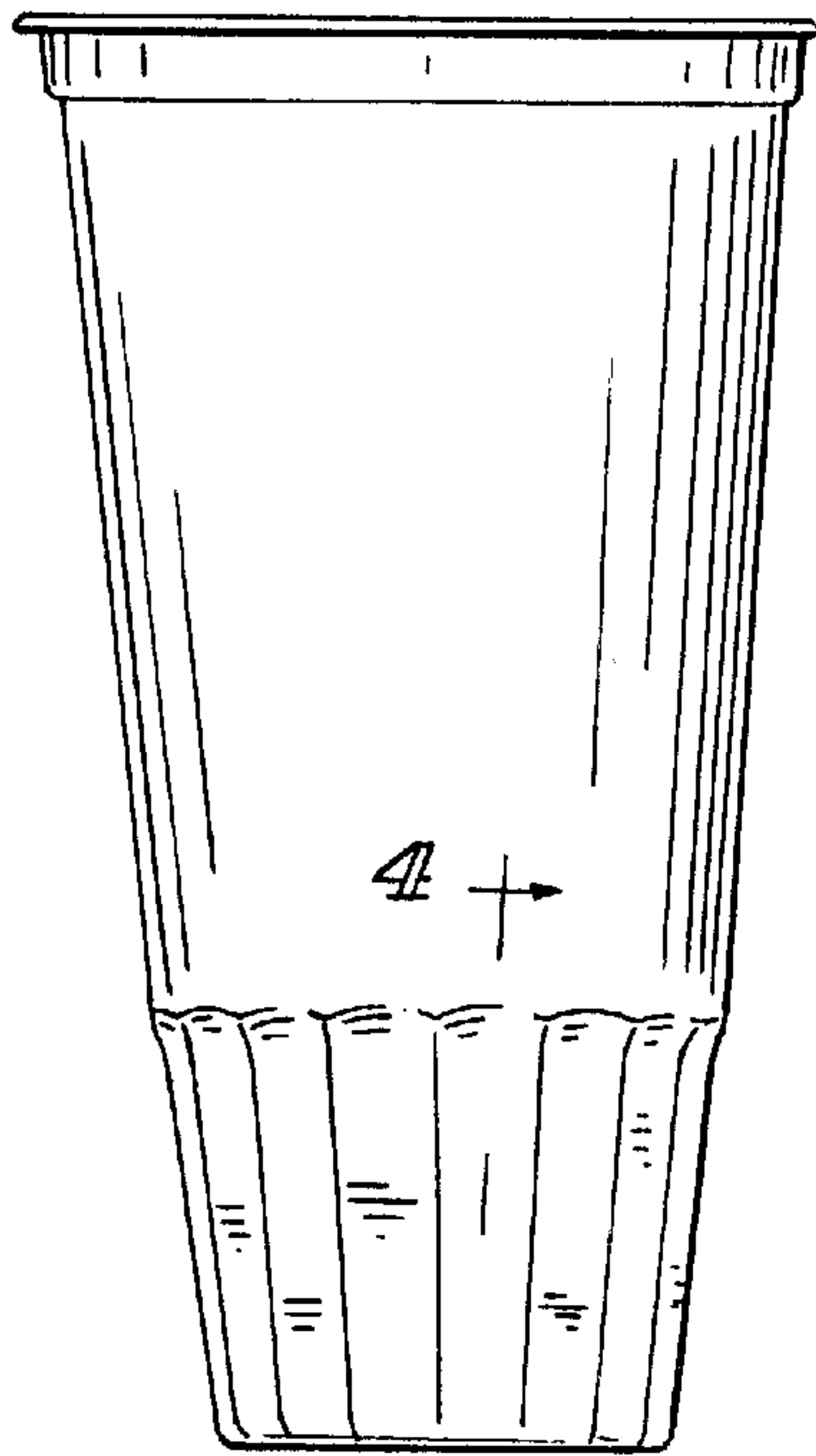

FIG. 1

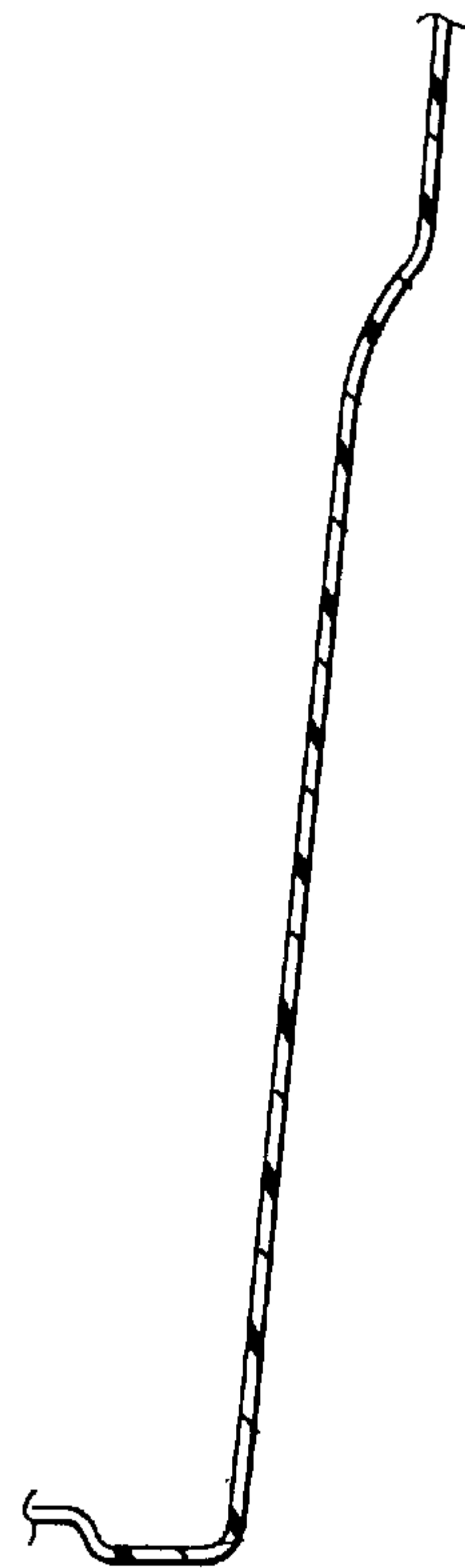

FIG. 4

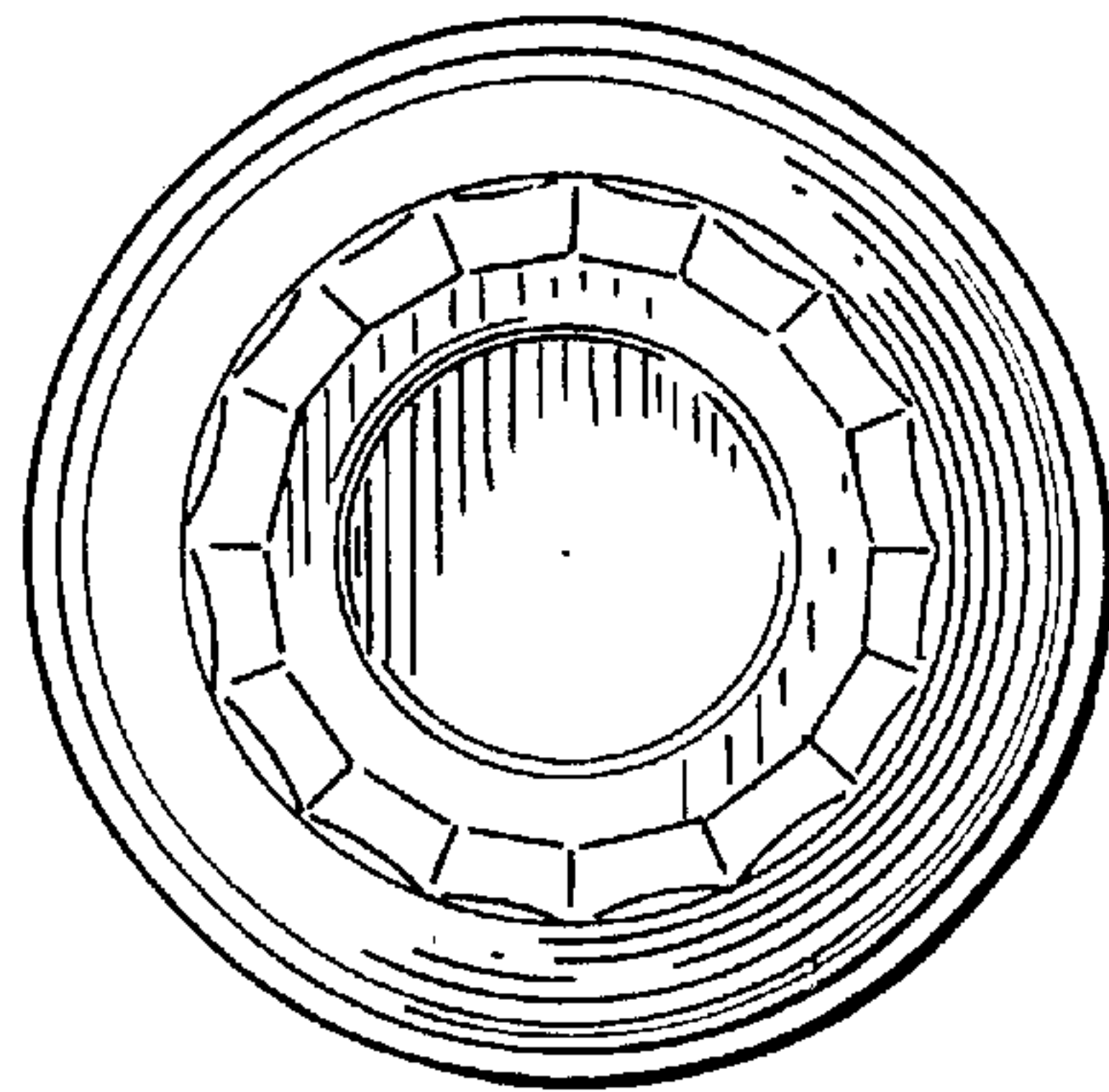

FIG. 3

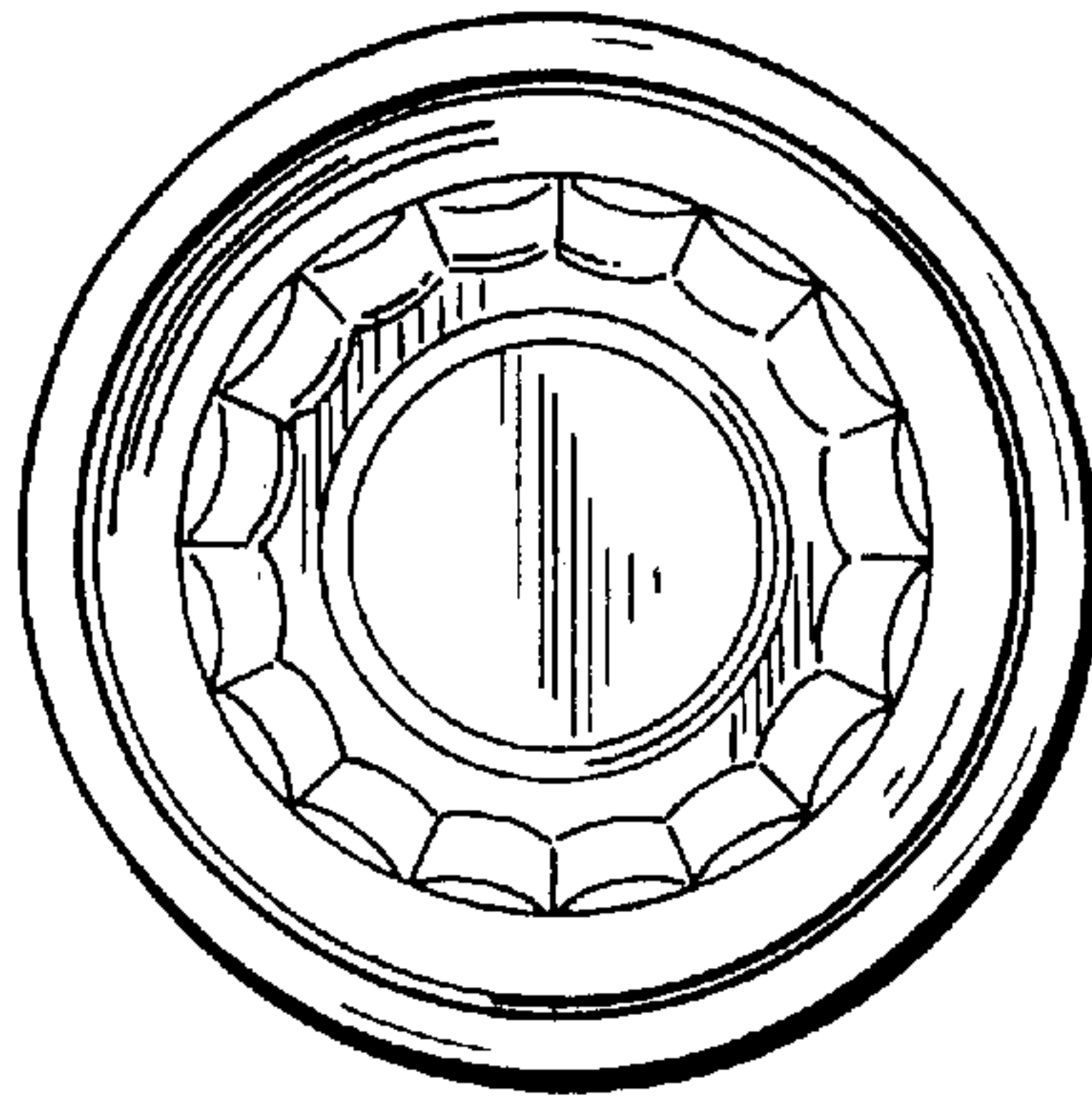

FIG. 6

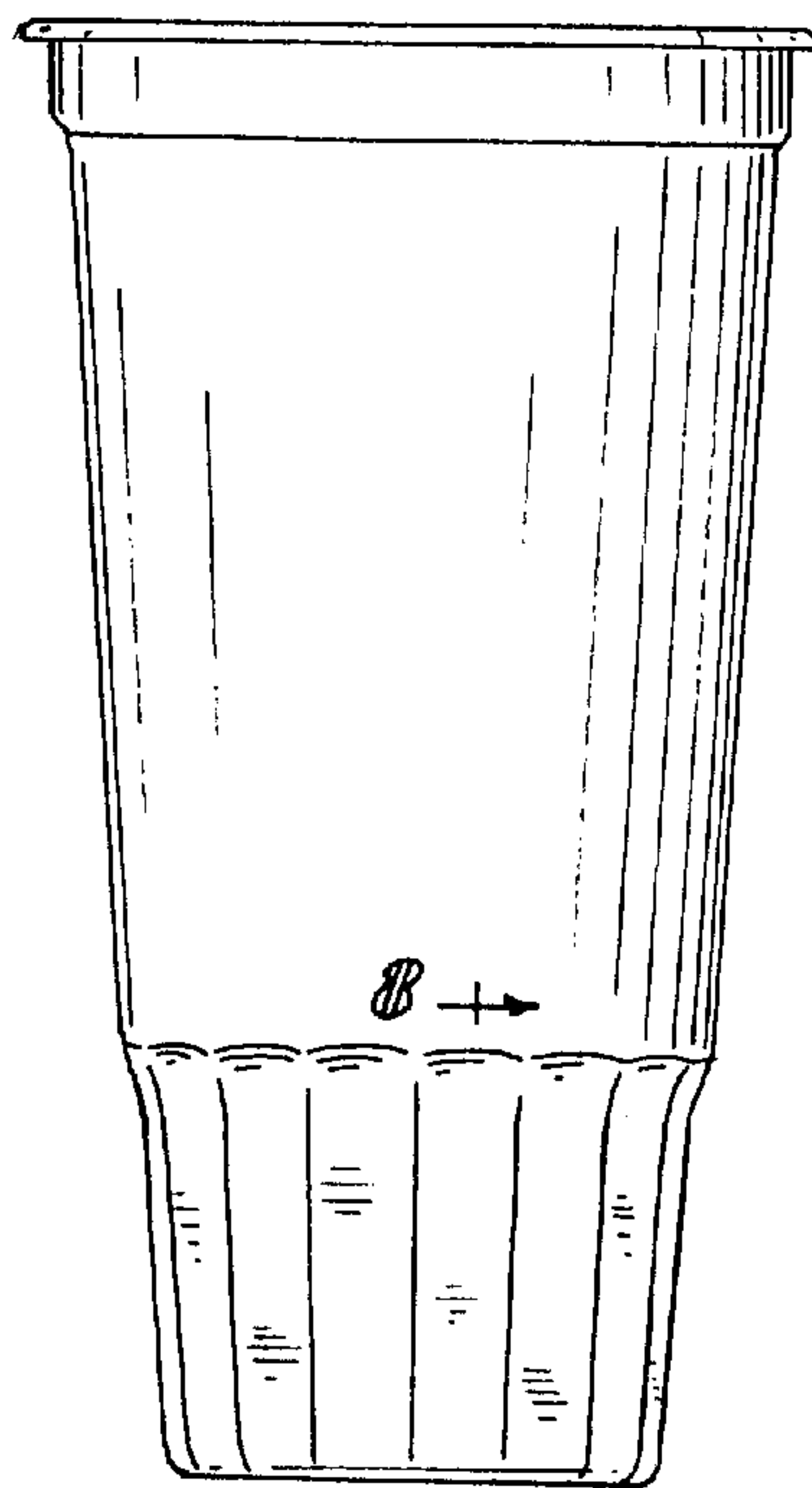

FIG. 5 <sup>B</sup> →

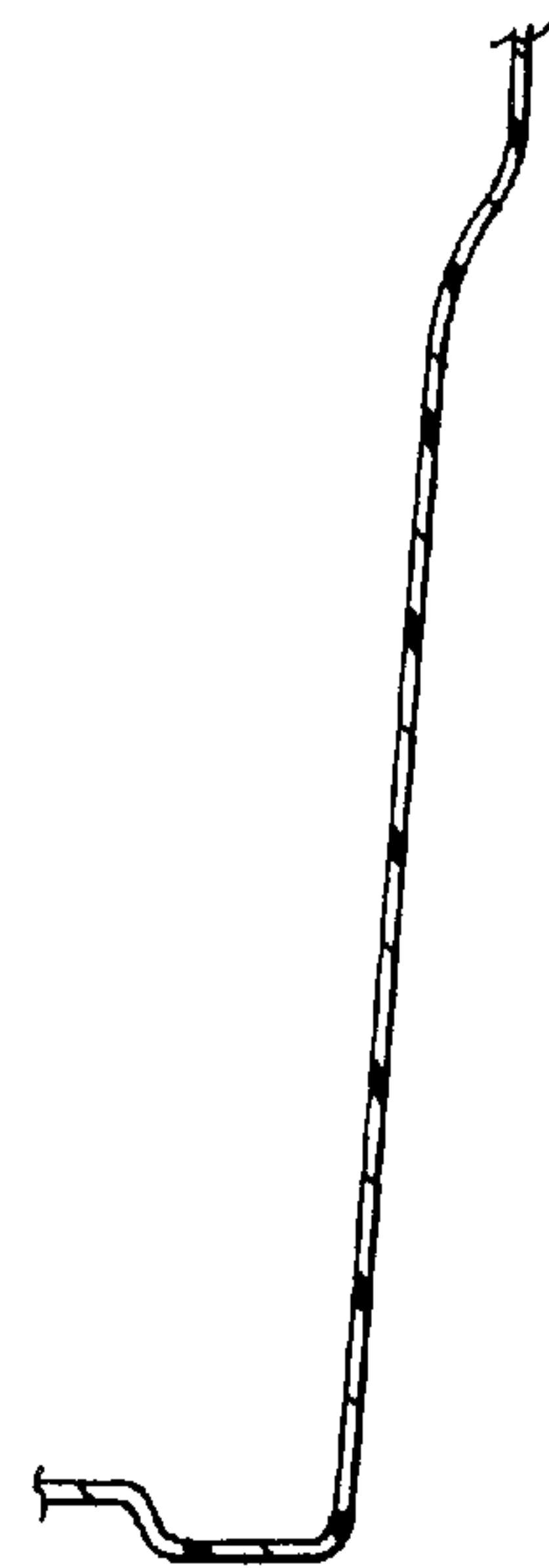

FIG. 8

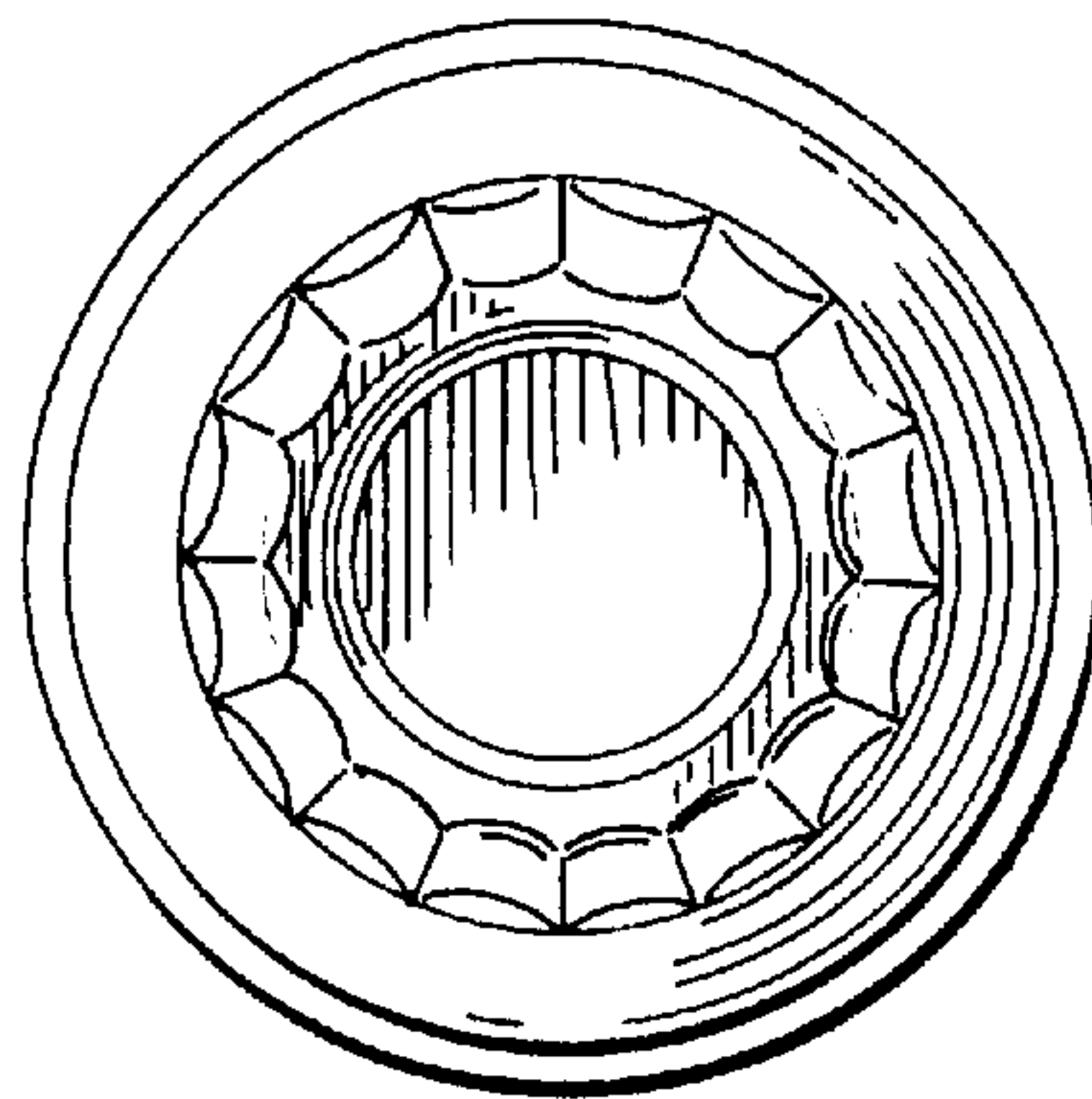

FIG. 7

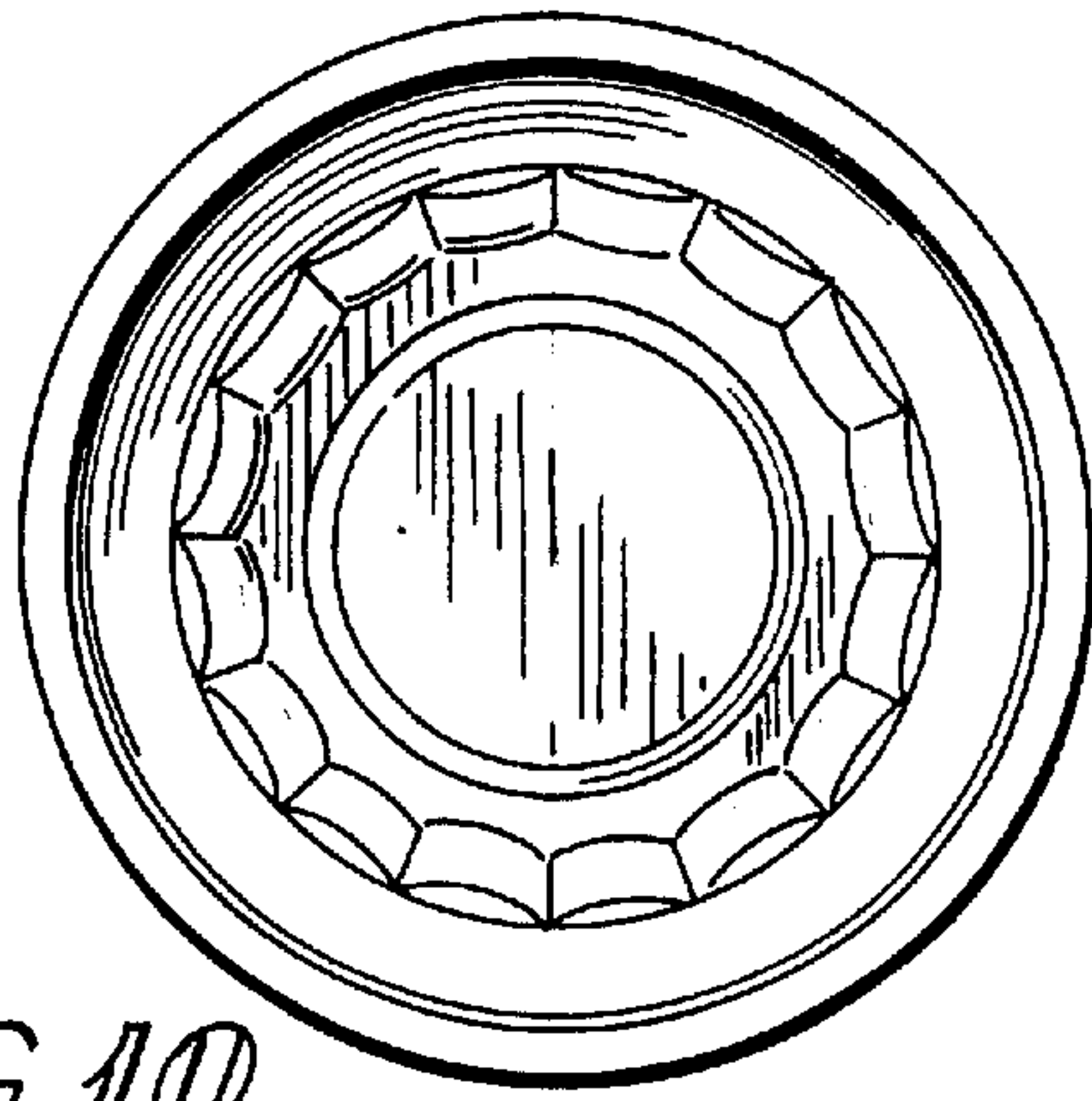

FIG. 10

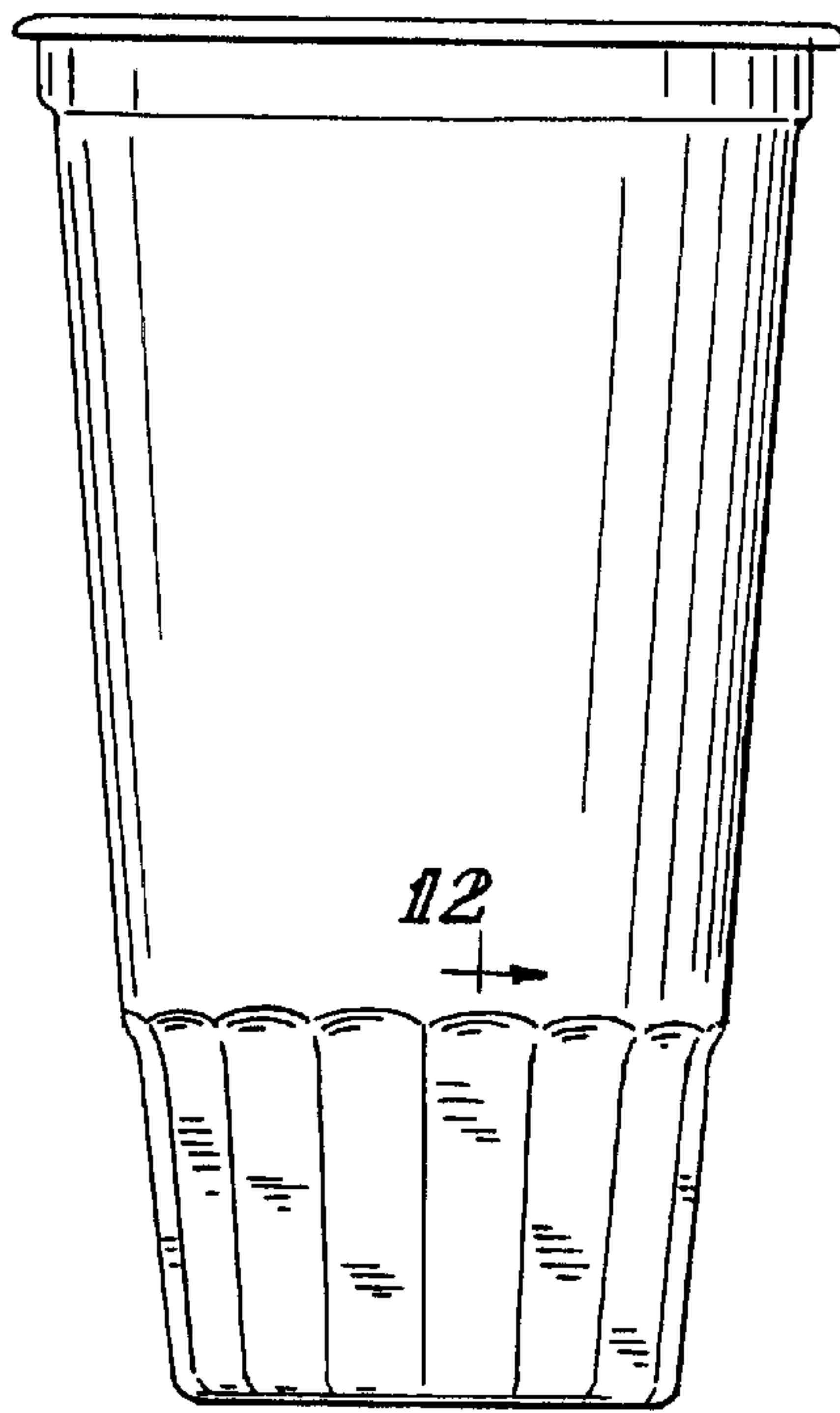

FIG. 9 12 →

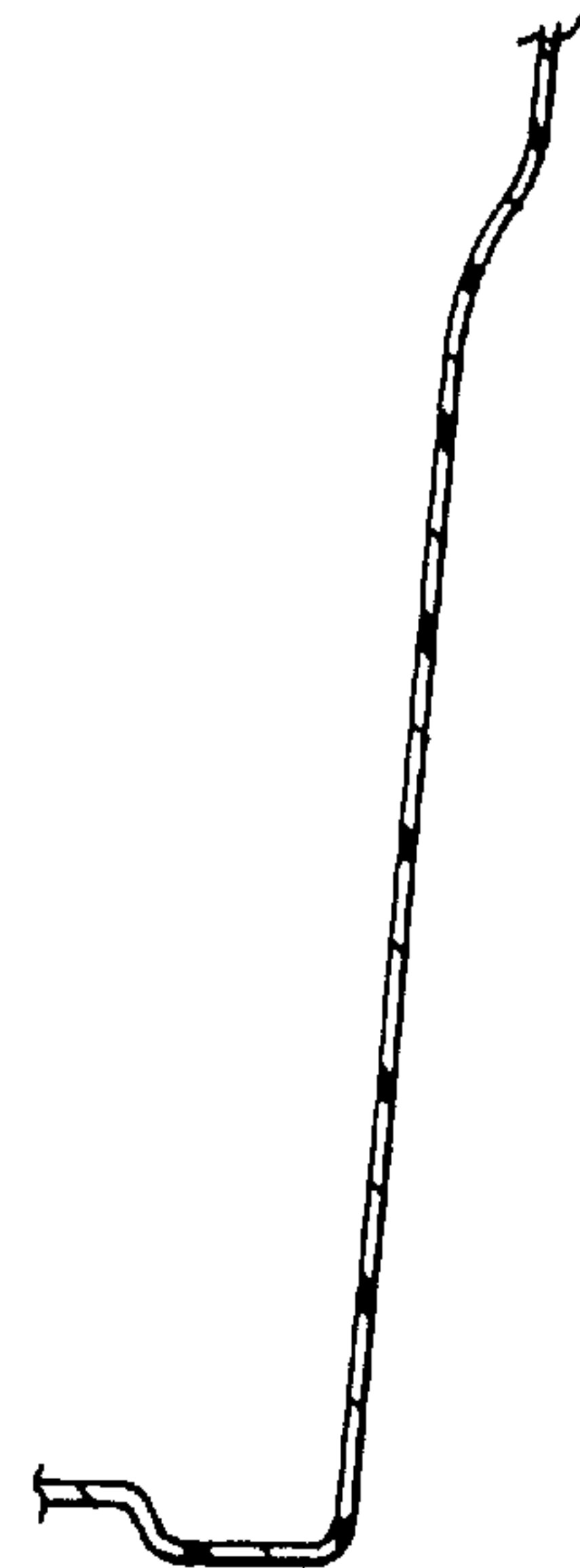

FIG. 12

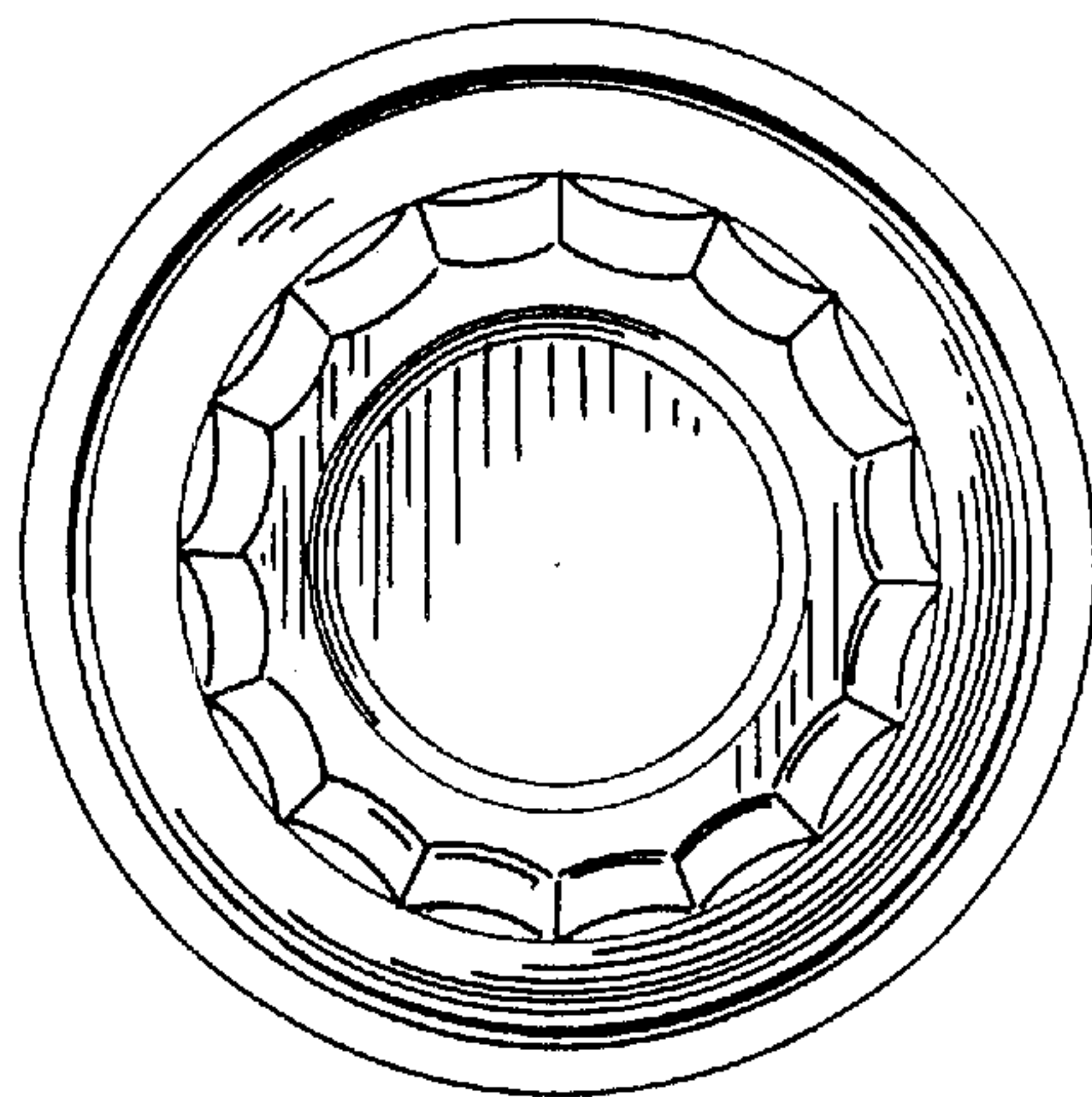

FIG. 11