



US00D461346S

(12) **United States Design Patent**
Matern

(10) **Patent No.:** **US D461,346 S**

(45) **Date of Patent:** **** Aug. 13, 2002**

(54) **CHAIR CONTROL HOUSING**

(75) Inventor: **Gerard J. Matern, Waterloo (CA)**

(73) Assignee: **Northfield Metal Products Limited, Waterloo (CA)**

(**) Term: **14 Years**

(21) Appl. No.: **29/135,775**

(22) Filed: **Jan. 18, 2001**

(51) **LOC (7) Cl.** **06-06**

(52) **U.S. Cl.** **D6/500**

(58) **Field of Search** D6/364, 365, 366,
D6/367, 500, 501, 502; 248/161, 578; 297/344.18,
344.19, 344.21

(56) **References Cited**

U.S. PATENT DOCUMENTS

D242,514 S	*	11/1976	Doerner	D6/500
D247,943 S	*	5/1978	Doerner	D6/500
D289,591 S	*	5/1987	Groseth	D6/500
D290,073 S	*	6/1987	Doerner	D6/500
D292,459 S	*	10/1987	Doerner	D6/500
D447,652 S	*	9/2001	Beggs	D6/500

* cited by examiner

Primary Examiner—Gary D. Watson

(74) *Attorney, Agent, or Firm*—Shook, Hardy & Bacon L.L.P.

(57) **CLAIM**

The ornamental design for a chair control housing, as shown and described.

DESCRIPTION

FIG. 1 is a left side perspective view of the chair control housing;
 FIG. 2 is a bottom view of the chair control housing of FIG. 1;
 FIG. 3 is a right side view of the chair control housing of FIG. 1;
 FIG. 4 is a left side view of the chair control housing of FIG. 1;
 FIG. 5 is a front view of the chair control housing of FIG. 1;
 FIG. 6 is a rear view of the chair control housing of FIG. 1; and,
 FIG. 7 is a top view of the chair control housing of FIG. 1.
 The broken lines shown in FIG. 1 are for environmental purposes only. The broken lines which define boundary line edges of the design are shown in FIGS. 1 through 7. All broken lines form no part of the claimed design.

1 Claim, 5 Drawing Sheets

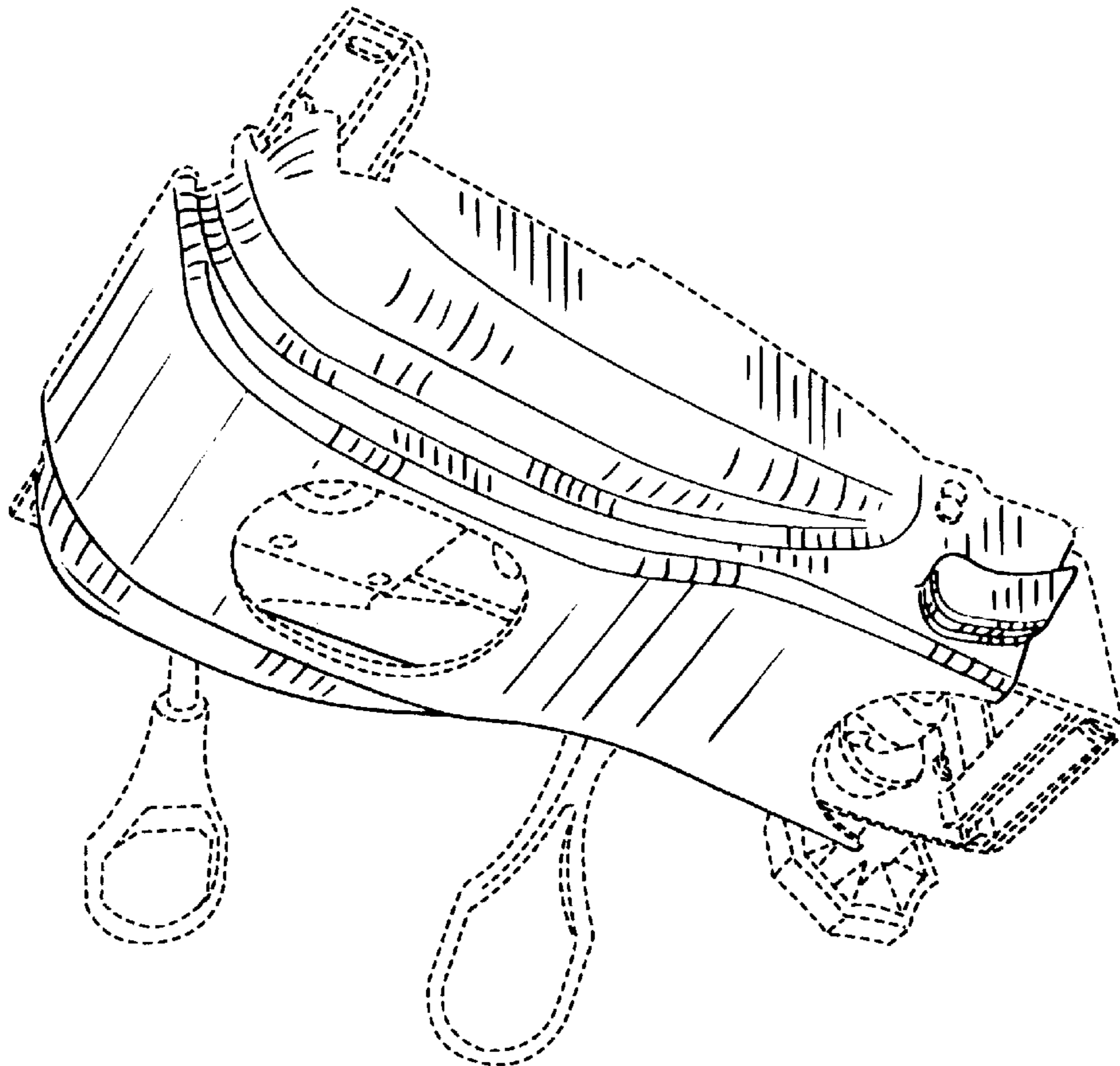

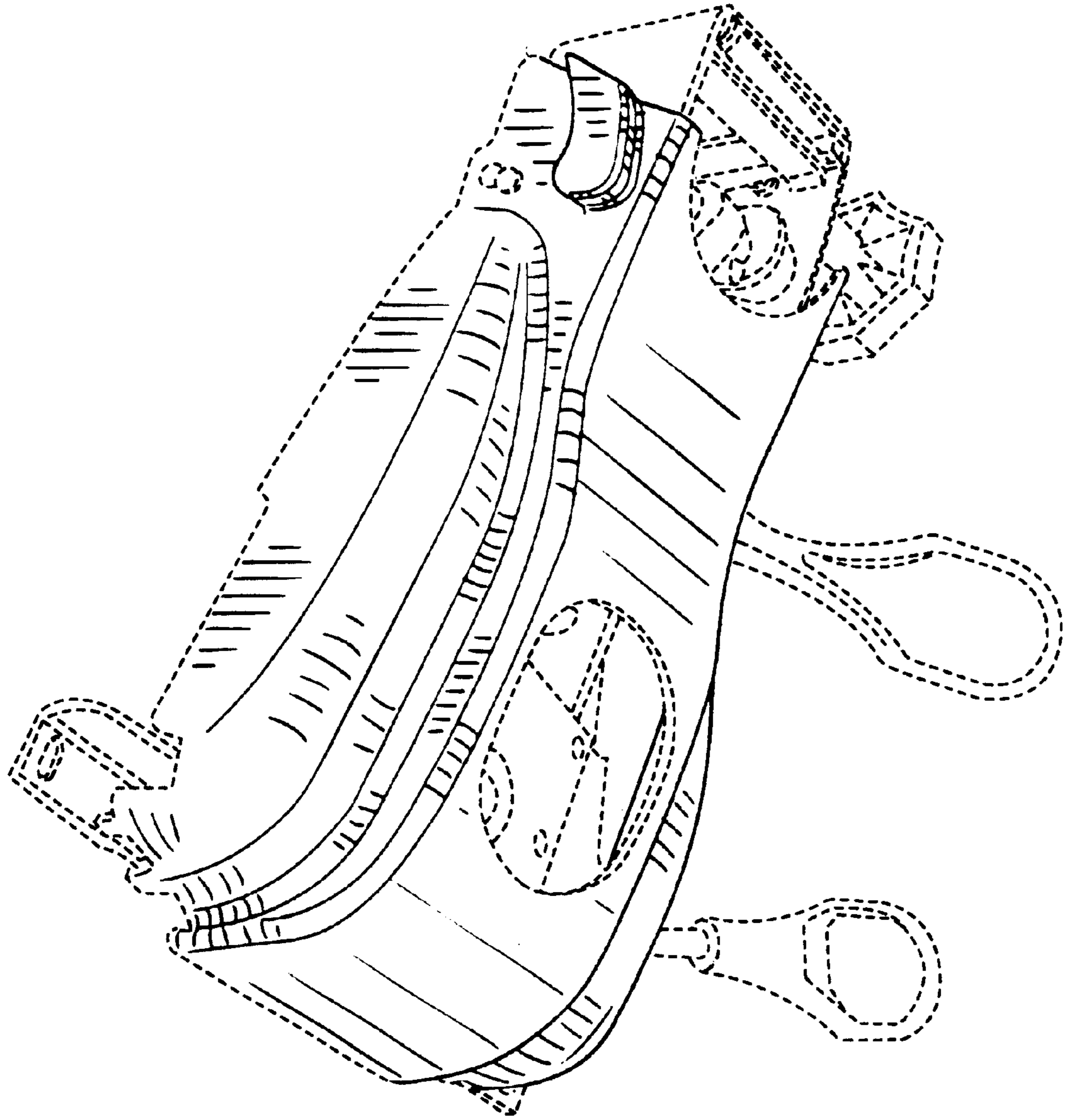
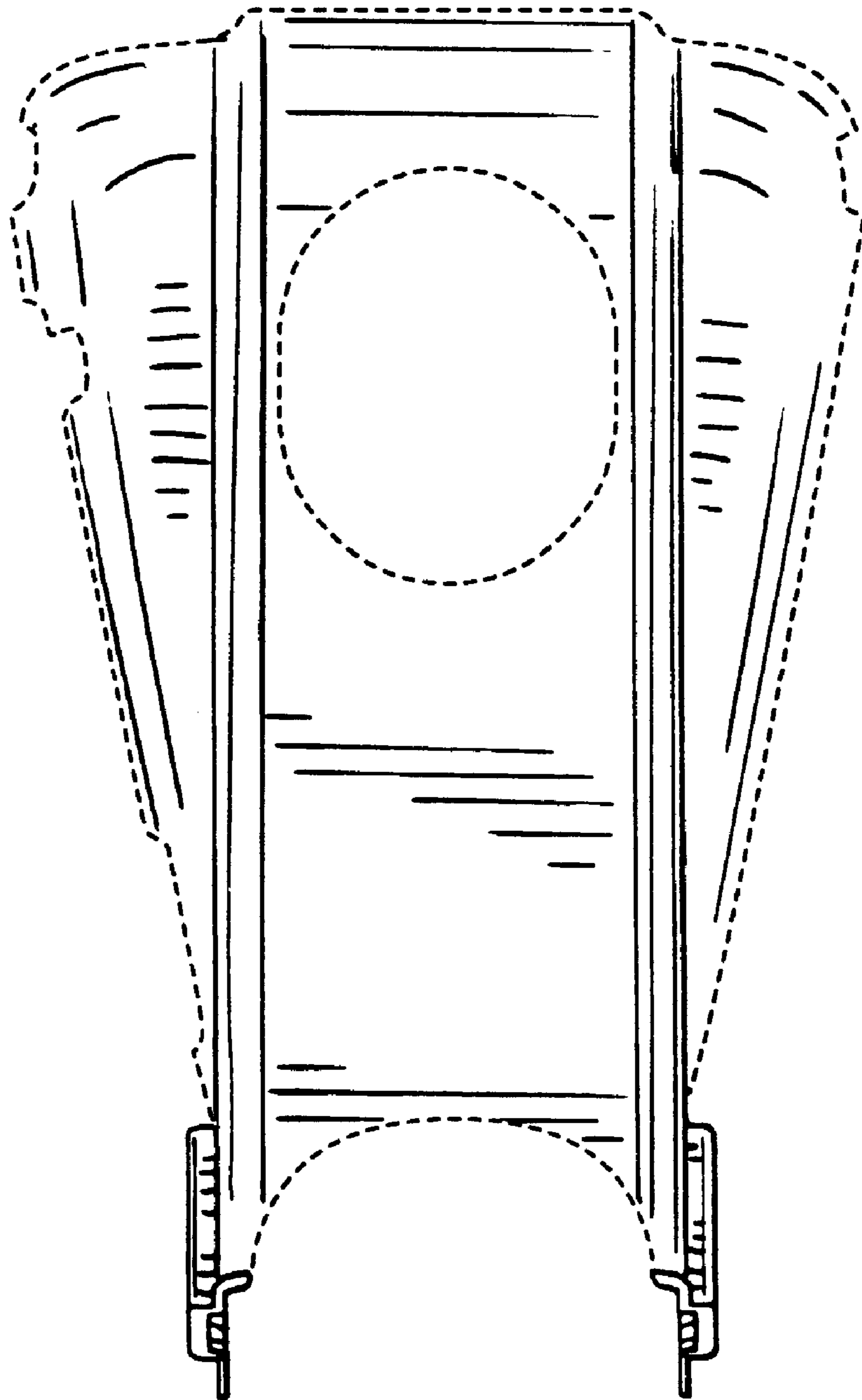

FIG. 1

FIG. 2



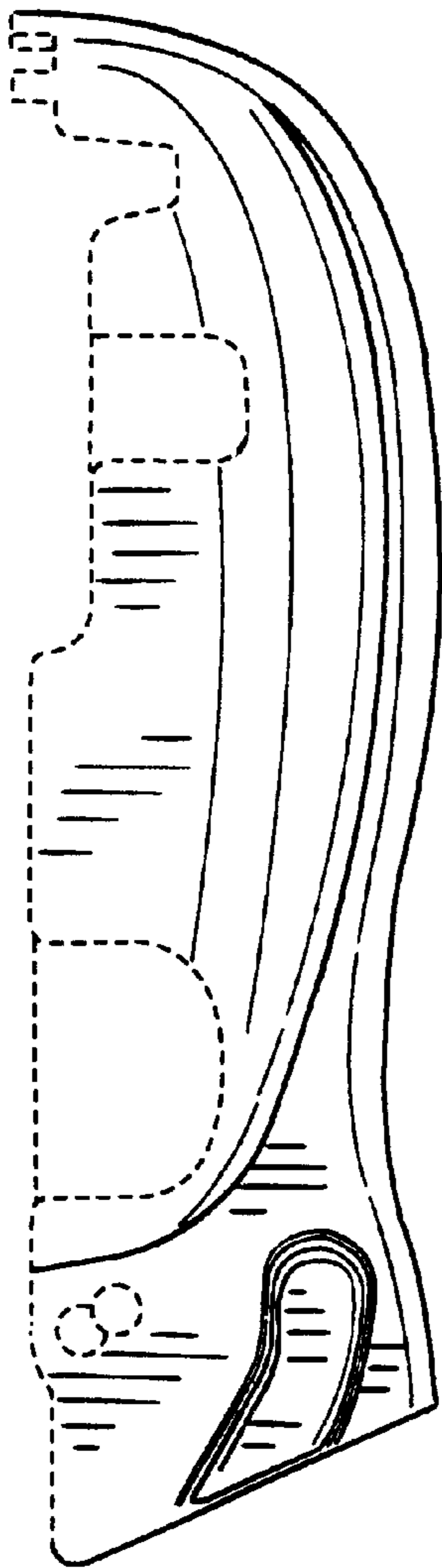

FIG. 3

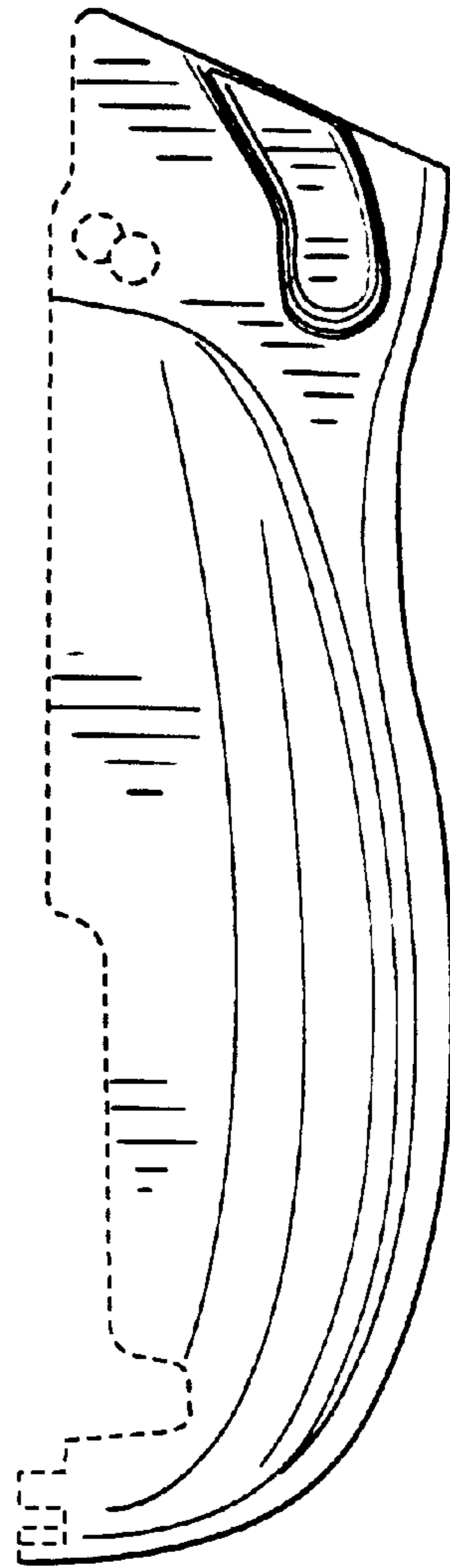

FIG. 4

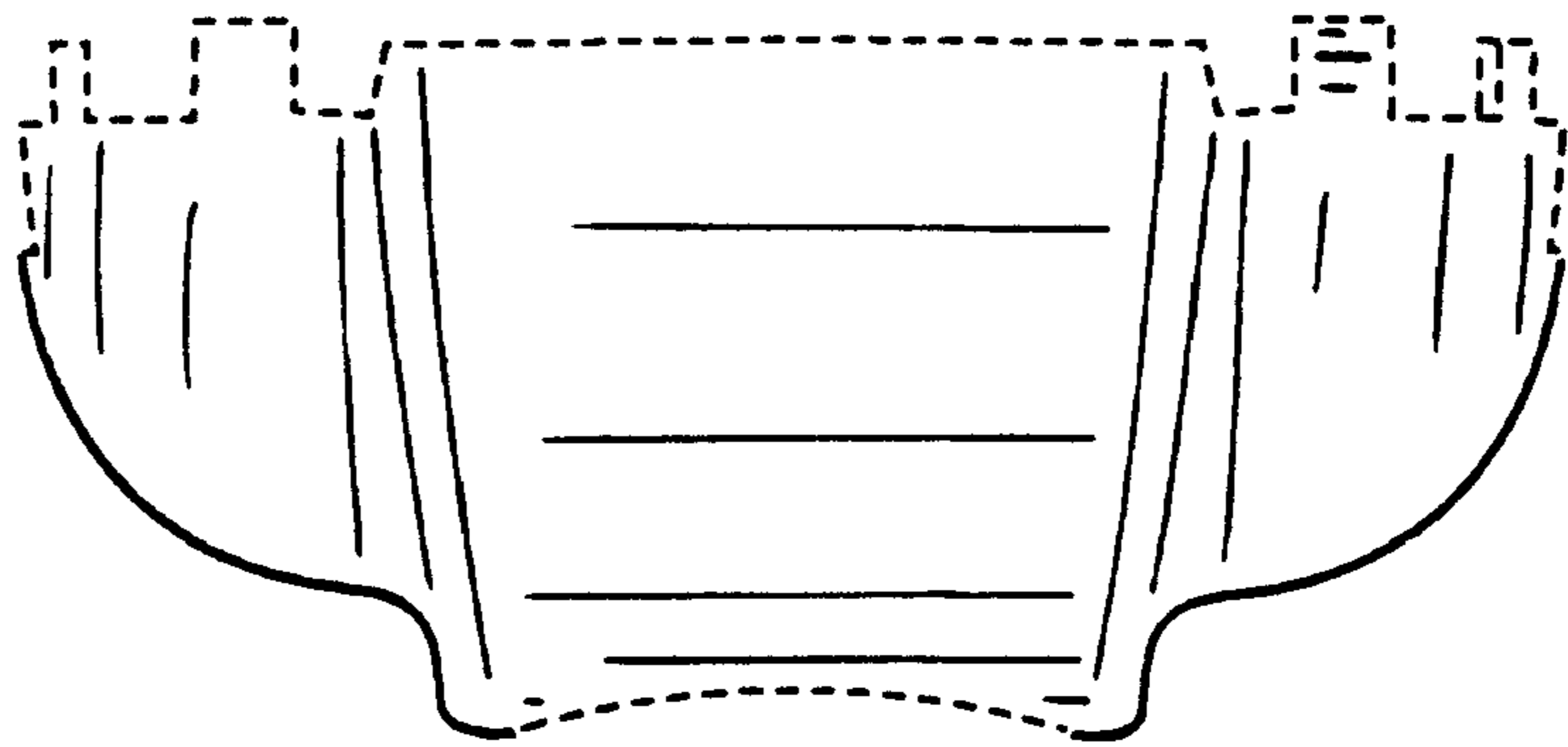

FIG. 5

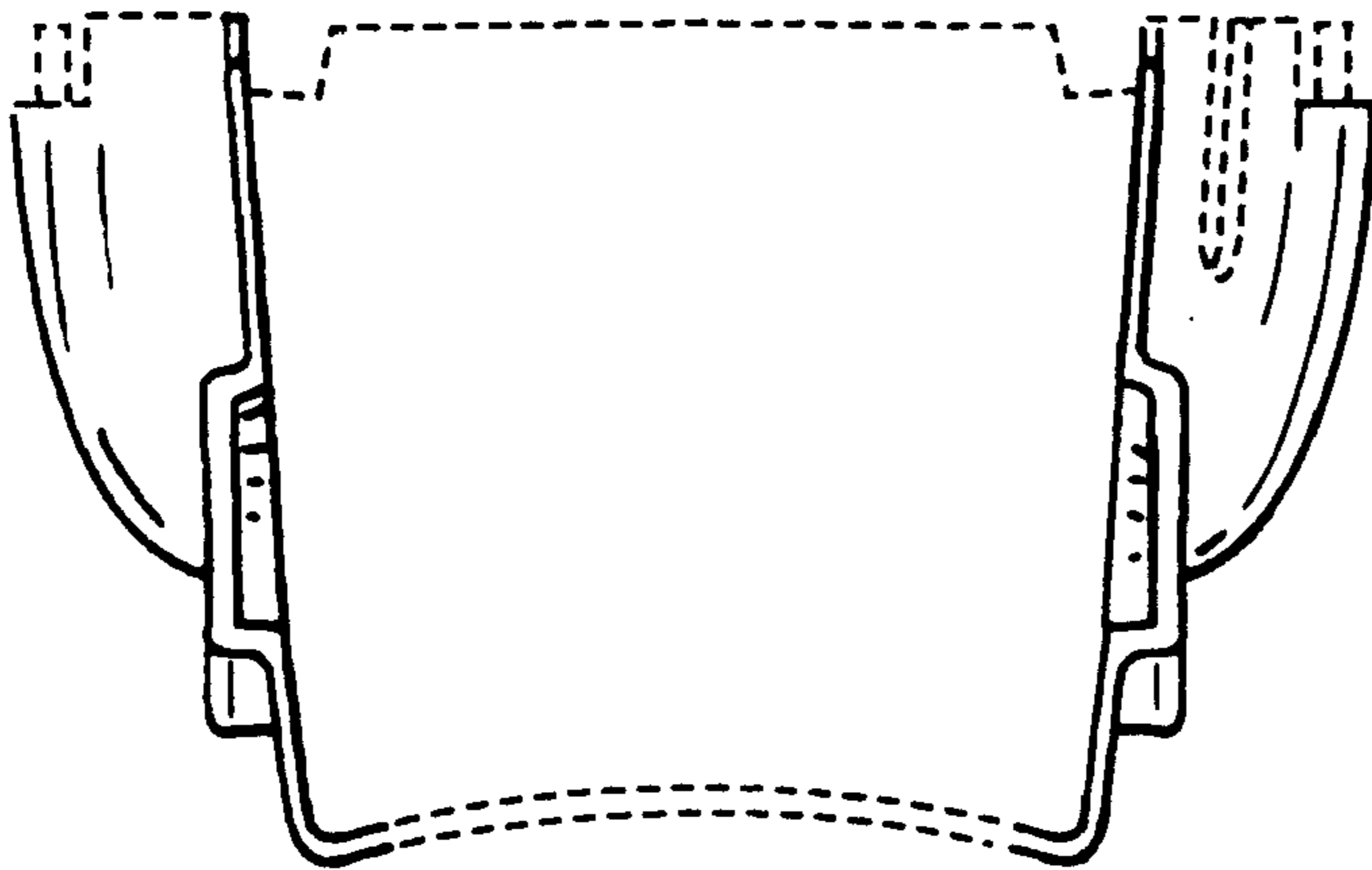

FIG. 6

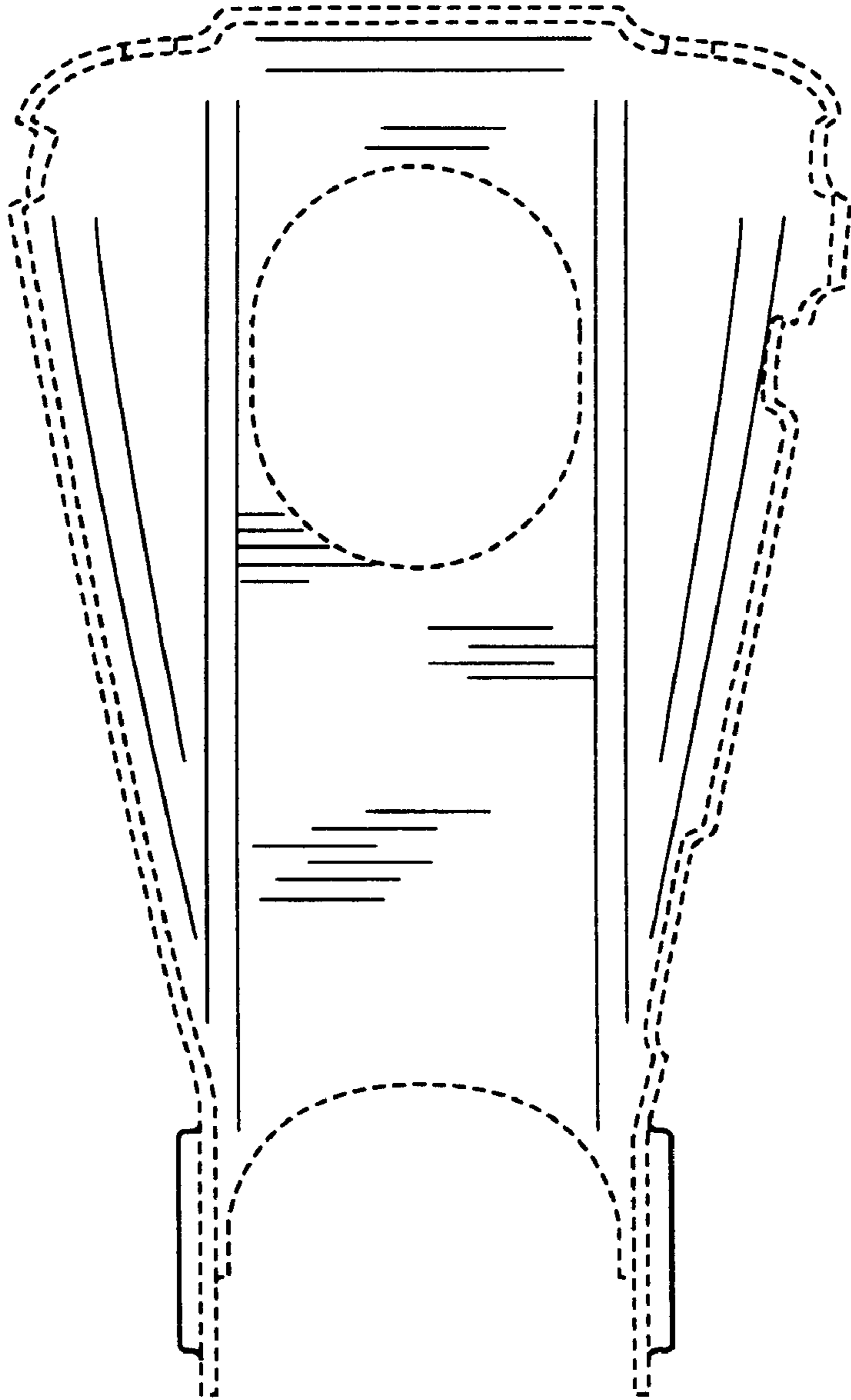

FIG. 7