



US00D461325S

(12) **United States Design Patent**  
**Opsvik**

(10) **Patent No.:** **US D461,325 S**

(45) **Date of Patent:** **\*\* Aug. 13, 2002**

(54) **CHAIR**

(76) Inventor: **Peter Opsvik**, Pilestredet 27 H, Oslo  
(NO), N-0164

(\*\*) Term: **14 Years**

(21) Appl. No.: **29/153,719**

(22) Filed: **Jan. 10, 2002**

**Related U.S. Application Data**

(62) Division of application No. 29/130,388, filed on Sep. 29,  
2000.

(51) **LOC (7) Cl.** ..... **06-01**

(52) **U.S. Cl.** ..... **D6/367**

(58) **Field of Search** ..... D6/333, 334, 335,  
D6/336, 339, 348, 367, 370, 371, 372,  
379, 380, 492, 500-502; 297/338, 411.28,  
411.4

(56) **References Cited**

**U.S. PATENT DOCUMENTS**

4,109,961 A \* 8/1978 Opsvik ..... 297/338

D352,614 S \* 11/1994 Adams ..... D6/370

5,490,715 A \* 2/1996 Posvik ..... 297/270.1

5,558,397 A \* 9/1996 Chang ..... 297/281

\* cited by examiner

*Primary Examiner*—Doris V. Coles

*Assistant Examiner*—Mimosa De

(74) *Attorney, Agent, or Firm*—Volpe & Koenig, P.C.

(57) **CLAIM**

The ornamental design for a chair, as shown and described.

**DESCRIPTION**

FIG. 1 is a perspective view of a chair in accordance with the  
inventive design;

FIG. 2 is a top plan view thereof;

FIG. 3 is a front elevational view thereof;

FIG. 4 is a rear elevational view thereof;

FIG. 5 is a left side elevational view thereof, the right side  
elevational view being a mirror image; and,

FIG. 6 is a bottom plan view thereof.

**1 Claim, 3 Drawing Sheets**

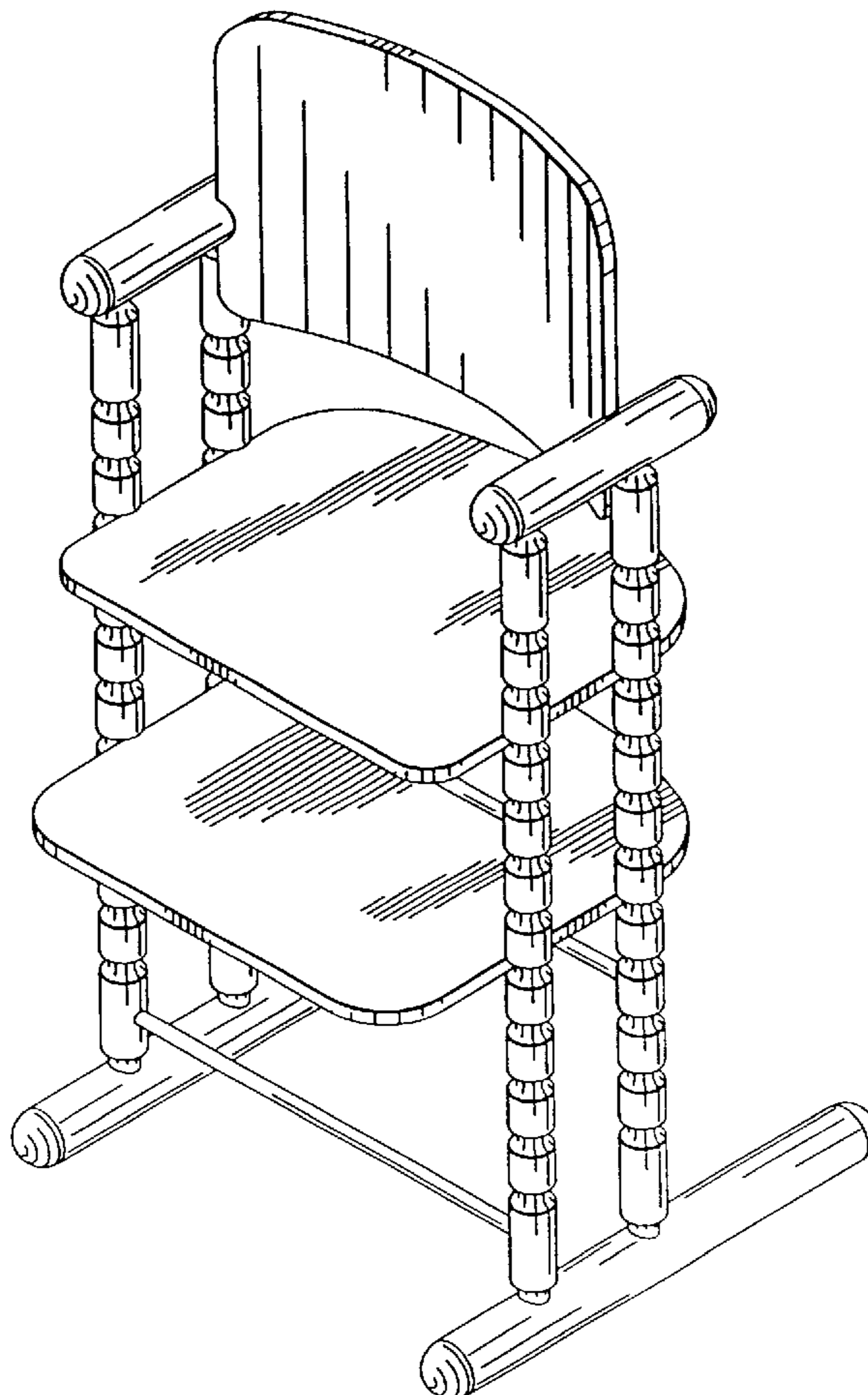

FIG. 1

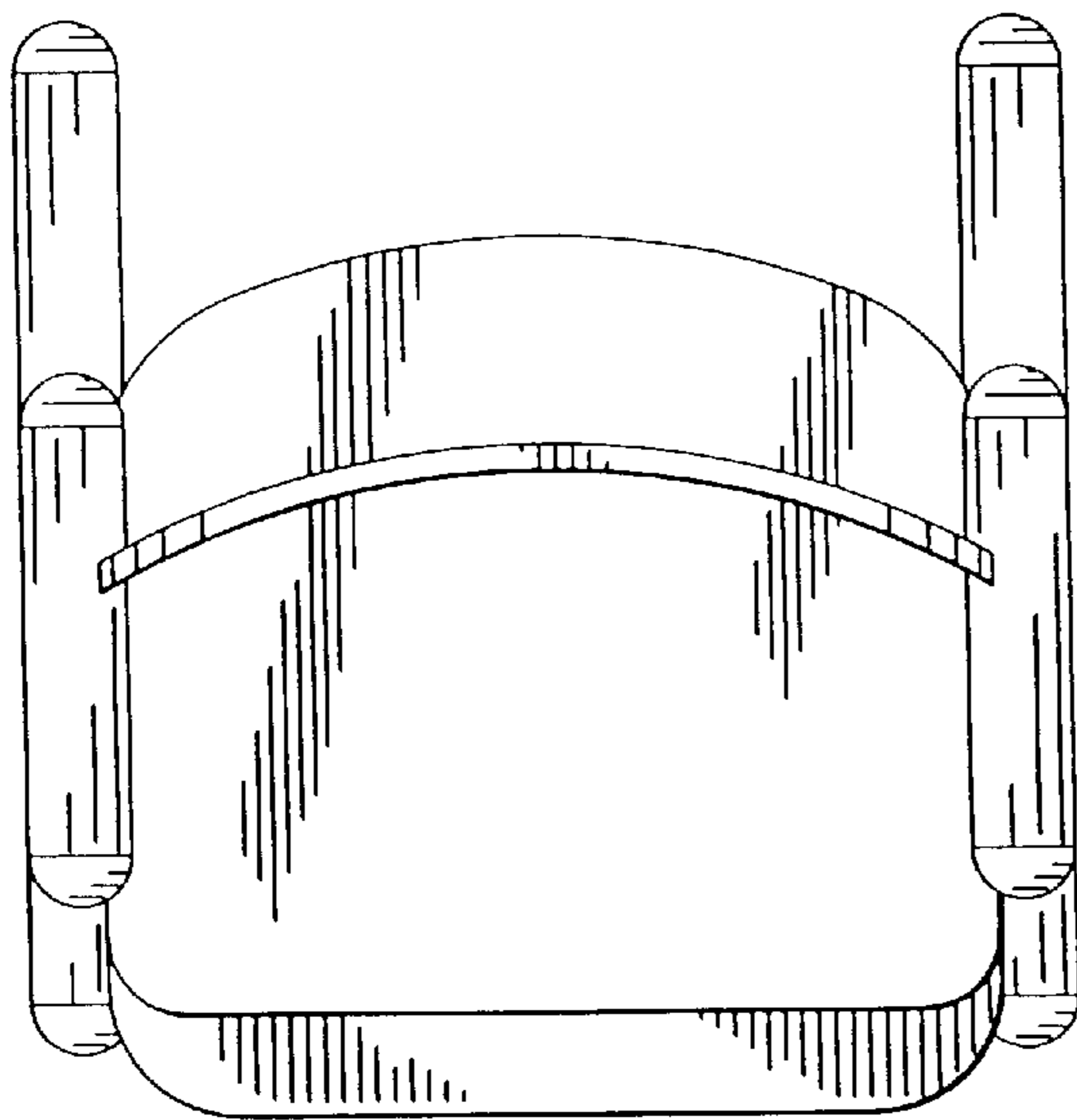
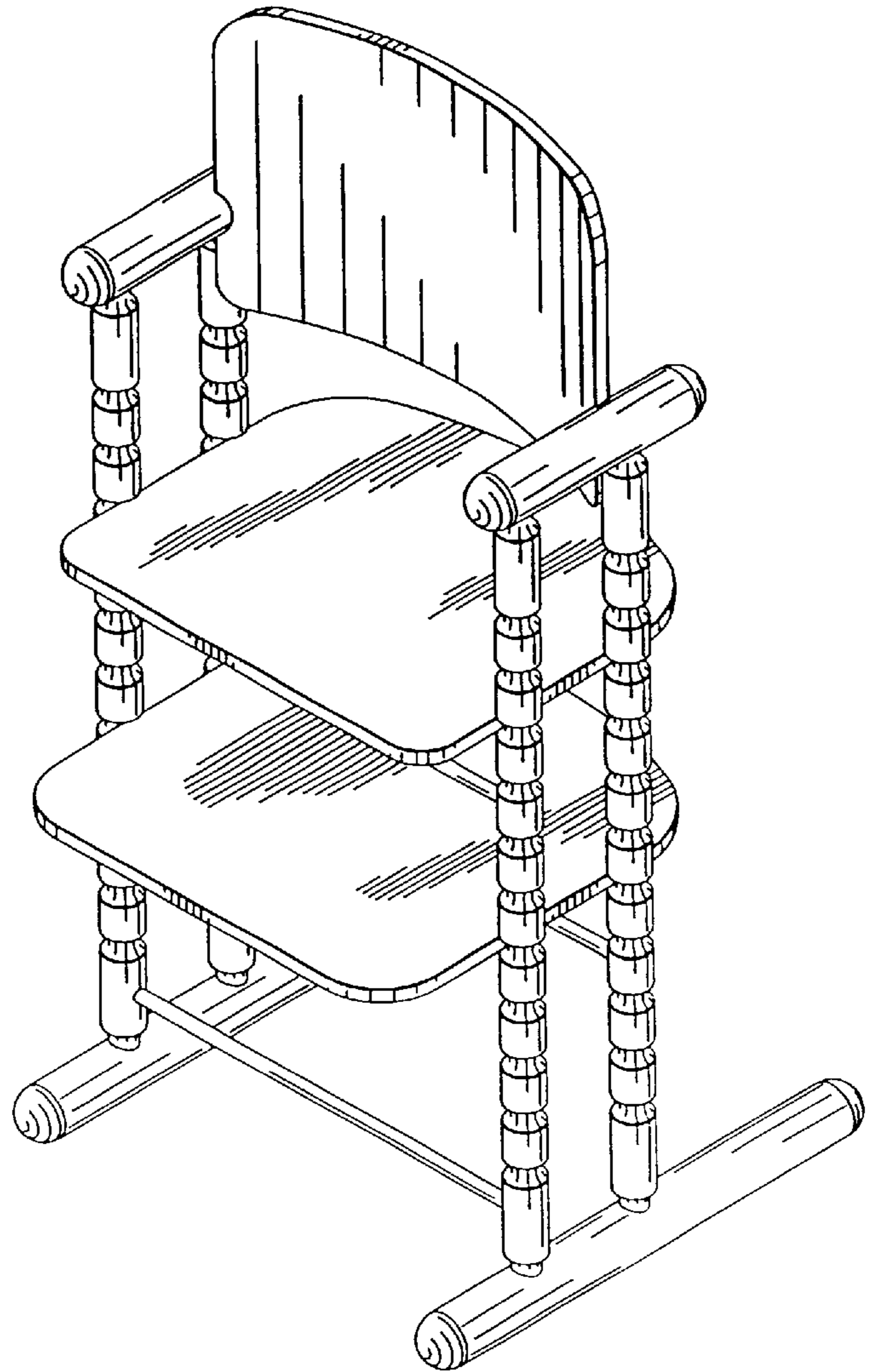

FIG. 2

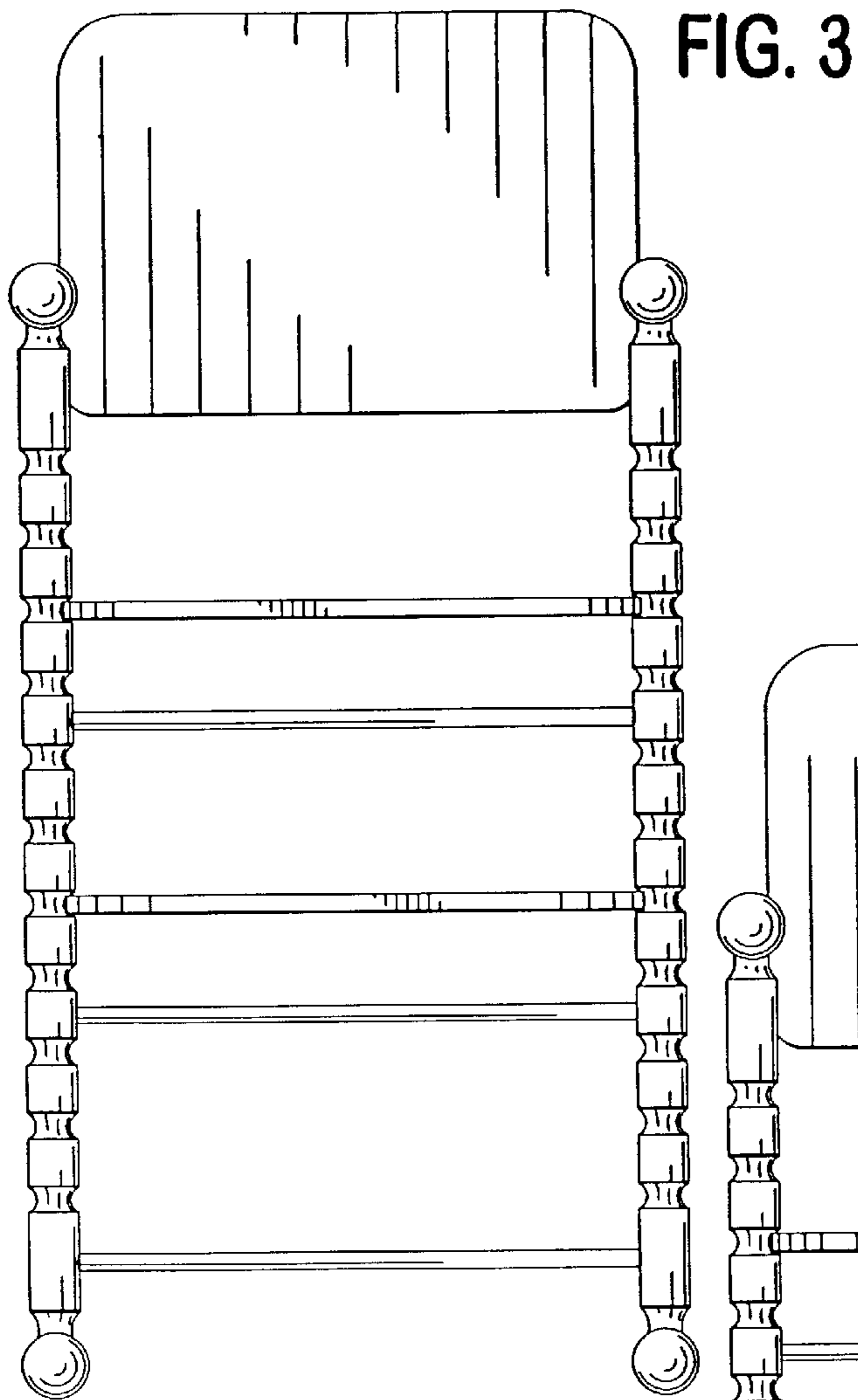
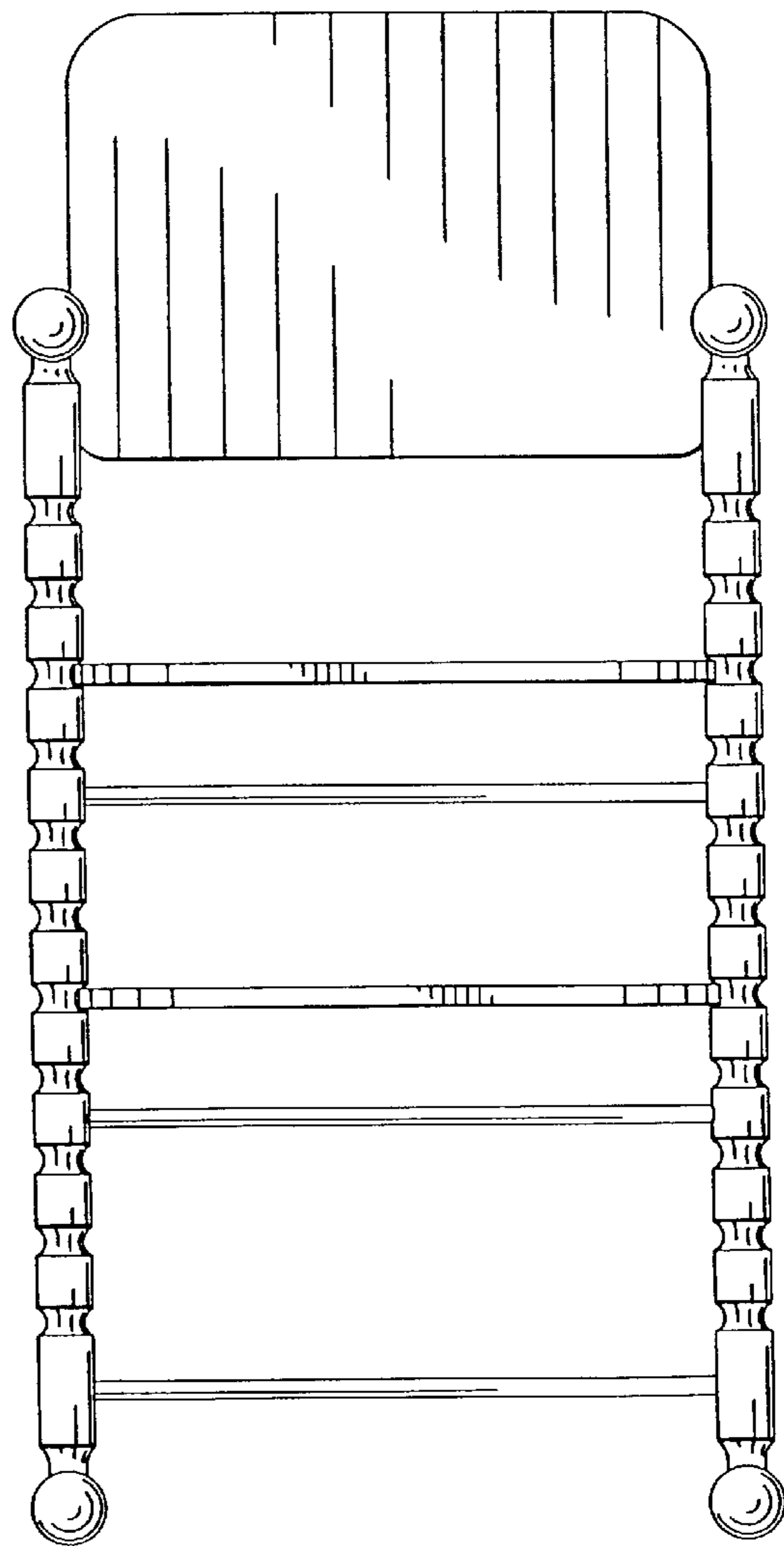

FIG. 4



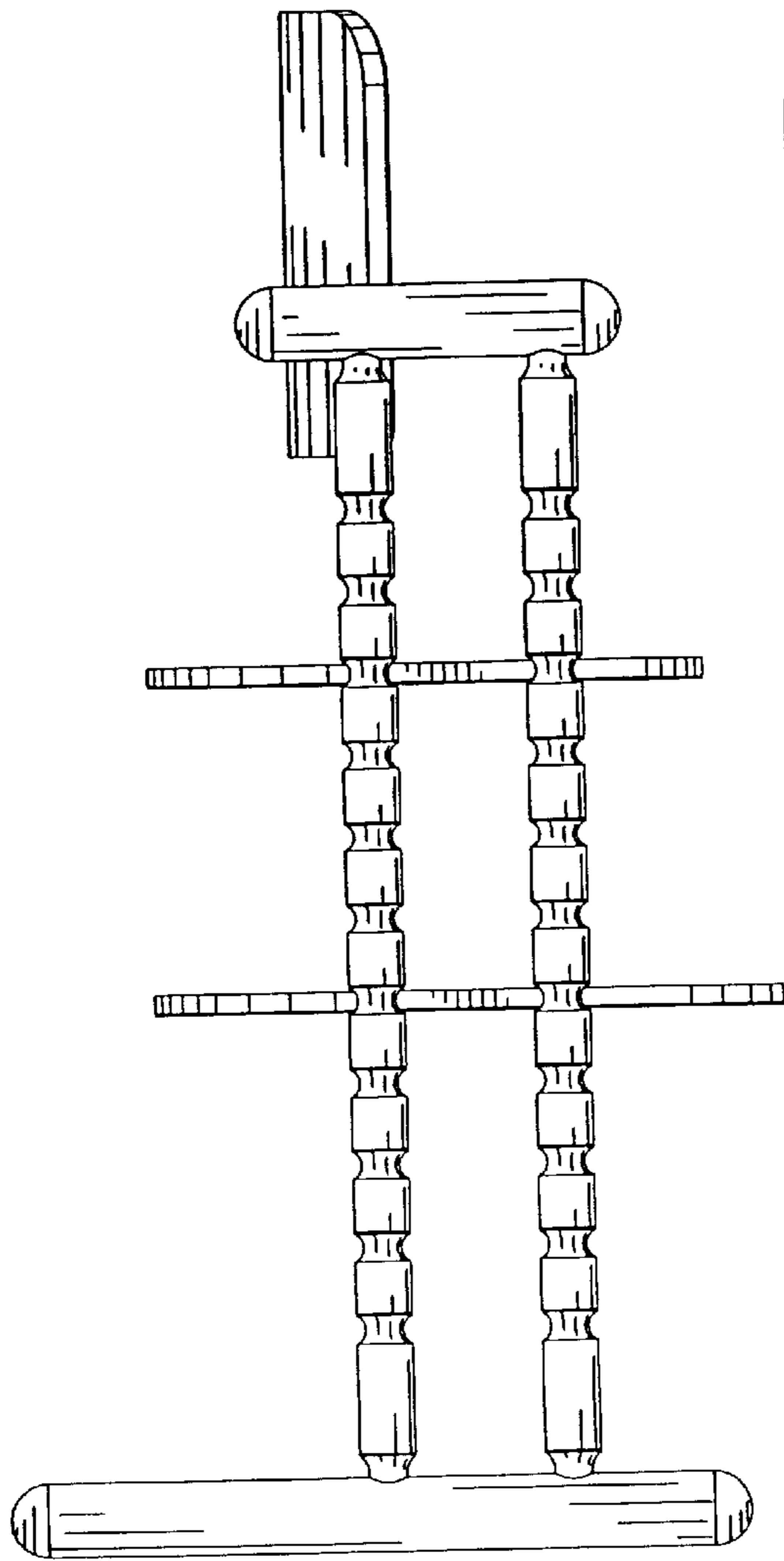

FIG. 5

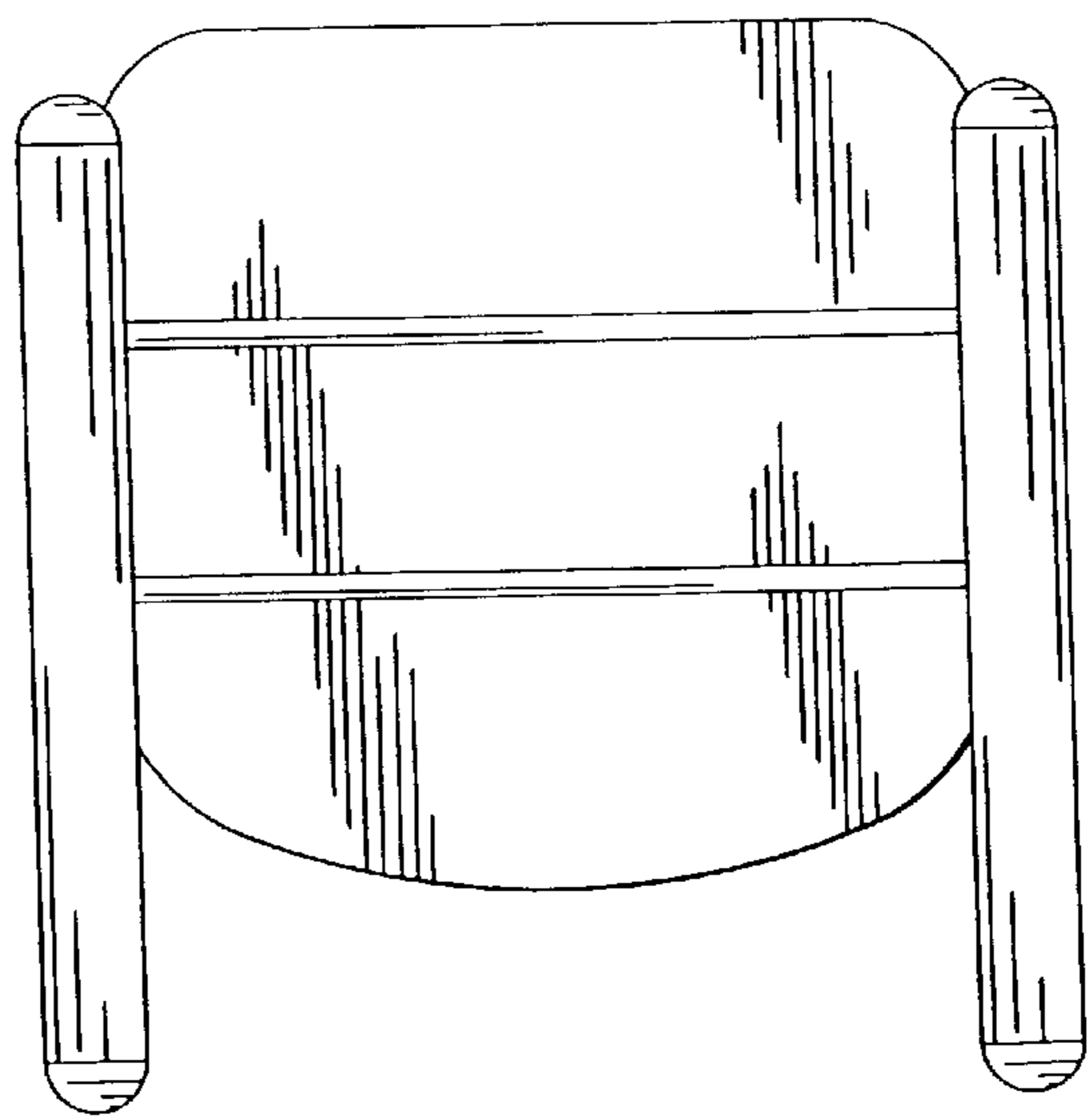

FIG. 6

UNITED STATES PATENT AND TRADEMARK OFFICE  
**CERTIFICATE OF CORRECTION**

PATENT NO. : Des. 461,325 S  
DATED : August 13, 2002  
INVENTOR(S) : Peter Opsvik

Page 1 of 1

It is certified that error appears in the above-identified patent and that said Letters Patent is hereby corrected as shown below:

Title page,

Item [56], **References Cited**, U.S. PATENT 5,490,715, delete "Posvik" and insert therefor -- Opsvik --.

Signed and Sealed this

Twenty-eighth Day of January, 2003

A handwritten signature in black ink, appearing to read "James E. Rogan", with a horizontal line drawn underneath it.

JAMES E. ROGAN  
*Director of the United States Patent and Trademark Office*