



US00D461175S

(12) **United States Design Patent**  
**Yokota**

(10) **Patent No.: US D461,175 S**

(45) **Date of Patent: \*\* Aug. 6, 2002**

(54) **COMBINED WIRELESS TELEPHONE AND  
PLAYER/RECORDER**

(75) Inventor: **Hiroaki Yokota, Tokyo (JP)**

(73) Assignee: **Sony Corporation, Tokyo (JP)**

(\*\*) Term: **14 Years**

(21) Appl. No.: **29/148,251**

(22) Filed: **Sep. 18, 2001**

(51) **LOC (7) Cl. .... 14-03**

(52) **U.S. Cl. .... D14/144; D14/138; D14/168;  
D14/341**

(58) **Field of Search** ..... D14/137, 138,  
D14/218, 147-148, 247-248, 336, 496,  
144, 167, 168, 341-347, 163-165; 379/433.01-433.13,  
419, 434, 428.01-428.04, 420.01-420.04,  
440; 455/550-575, 90; D13/168; D18/2,  
7

(56) **References Cited**

**U.S. PATENT DOCUMENTS**

D346,793 S	*	5/1994	Iino et al. ....	D14/341
D351,378 S	*	10/1994	Nakazawa et al. ....	D14/424
D363,271 S	*	10/1995	Peterson .....	D14/341
D389,465 S	*	1/1998	Heiman et al. ....	D14/336
D396,215 S	*	7/1998	Inukai .....	D14/341
D398,904 S	*	9/1998	Tamaki et al. ....	D14/341
D402,979 S		12/1998	Ogasawara	
D404,376 S	*	1/1999	Shane et al. ....	D14/341
D404,761 S	*	1/1999	Tarpenning et al. ....	D14/341
D408,372 S	*	4/1999	Ota et al. ....	D14/346
D408,375 S		4/1999	Oba	
D408,794 S		4/1999	Ogasawara	
D409,185 S	*	5/1999	Kawashima .....	D14/138
D411,181 S	*	6/1999	Tamaki et al. ....	D14/345
D413,328 S		8/1999	Kazama	
D413,597 S		9/1999	Oba	
D416,253 S		11/1999	Hibino	
D418,117 S	*	12/1999	Wade et al. ....	D14/342
D419,993 S	*	2/2000	Silzer, Jr. ....	D14/138
D422,271 S	*	4/2000	Kawashima .....	D14/343
D423,468 S	*	4/2000	Jenkins .....	D14/342
D423,508 S		4/2000	Nakajima	
D424,029 S	*	5/2000	Collins .....	D14/346

D425,067 S	*	5/2000	Nguyen et al. ....	D14/191
D428,018 S	*	7/2000	Amron .....	D14/496
D428,019 S	*	7/2000	Amron .....	D14/496
D430,134 S		8/2000	Obata et al.	
D432,511 S	*	10/2000	Eckholm .....	D14/138
D434,034 S	*	11/2000	Burke et al. ....	D14/341
D434,739 S	*	12/2000	Hanna et al. ....	D14/138
D437,593 S	*	2/2001	Keeler et al. ....	D14/336
D441,025 S		4/2001	Obata	
D441,359 S	*	5/2001	Iseki et al. ....	D14/341
D441,733 S	*	5/2001	Do et al. ....	D14/138
D441,735 S	*	5/2001	Katayama .....	D14/156
D442,569 S	*	5/2001	Hanna et al. ....	D14/138
D445,418 S	*	7/2001	Chen .....	D14/341
D451,097 S	*	11/2001	Schmeisser et al. ....	D14/371
D451,507 S	*	12/2001	Lin .....	D14/345
D452,488 S	*	12/2001	Ogasawara .....	D14/136
D453,149 S	*	1/2002	Skoger et al. ....	D14/138

**OTHER PUBLICATIONS**

Catalog "Personal Entertainment Organizer Clié", 3 sheets, Sony Corporation (Oct. 2000).

Web page on line catalog "Palm Computing Handheld Vx 3C80401J", 1 sheet, Palm Computing K.K. (Aug. 2001).

Web page "WorkPad c505", 2 sheets, IBM Corporation (Aug. 2001).

\* cited by examiner

*Primary Examiner*—Jeffrey Asch

(74) *Attorney, Agent, or Firm*—Rader, Fishman & Grauer, PLLC

(57) **CLAIM**

The ornamental design for a combined wireless telephone and player/recorder, as shown and described.

**DESCRIPTION**

FIG. 1 is a perspective view of a combined wireless telephone and player/recorder showing my new design; FIG. 2 is a front elevational view thereof; FIG. 3 is a rear elevational view thereof; FIG. 4 is a left side elevational view thereof; FIG. 5 is a right side elevational view thereof; FIG. 6 is a top plan view thereof; and, FIG. 7 is a bottom plan view thereof.

**1 Claim, 4 Drawing Sheets**

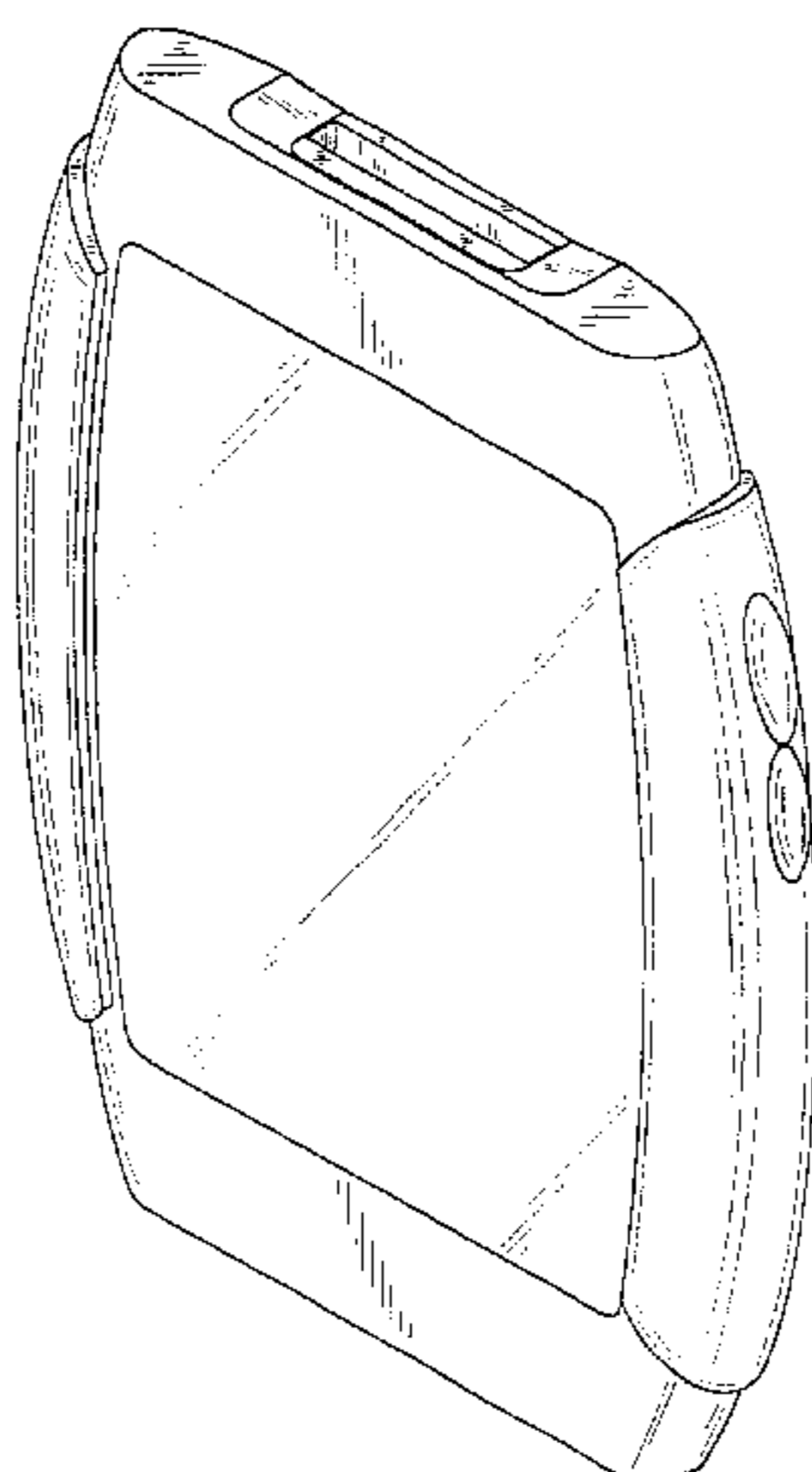

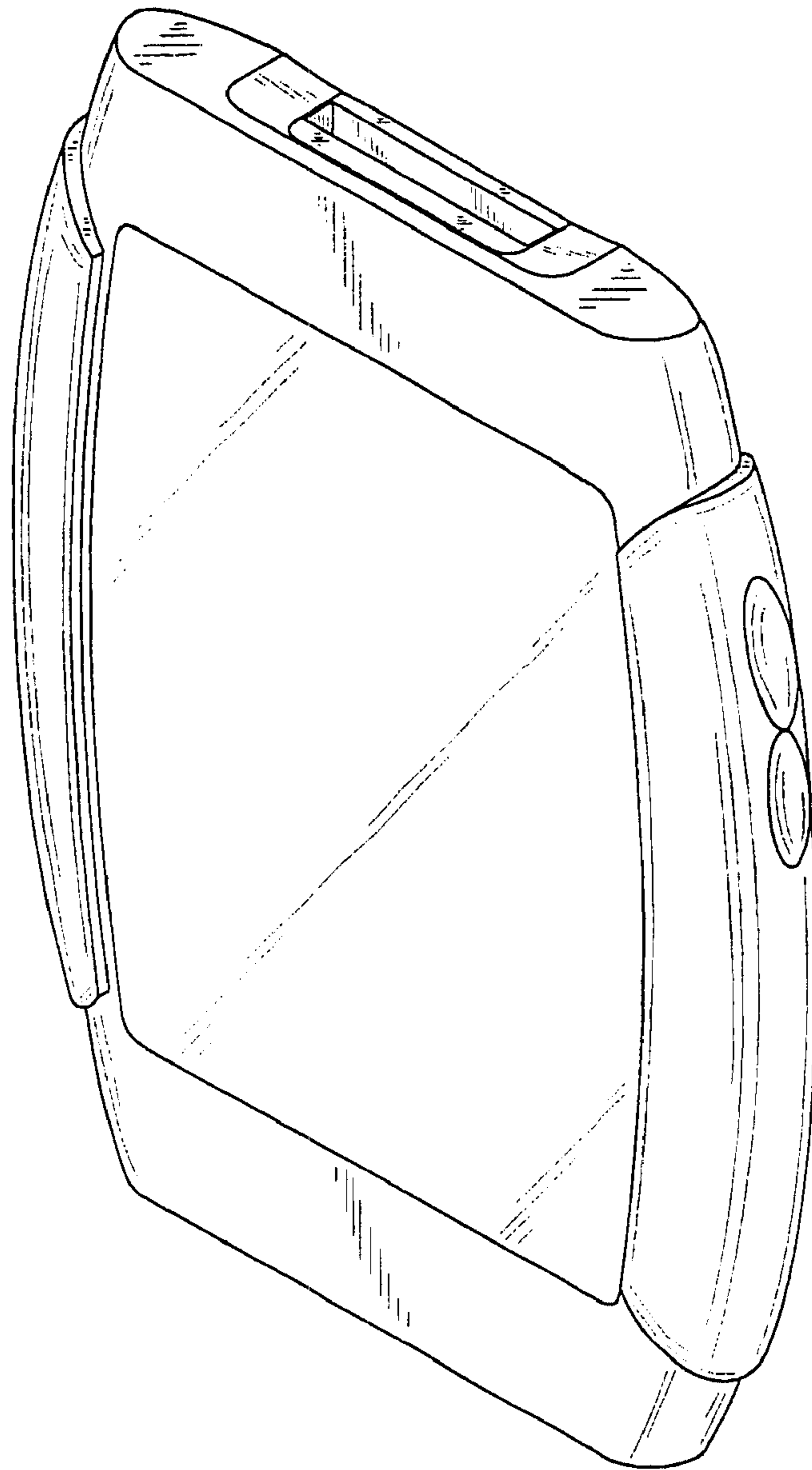
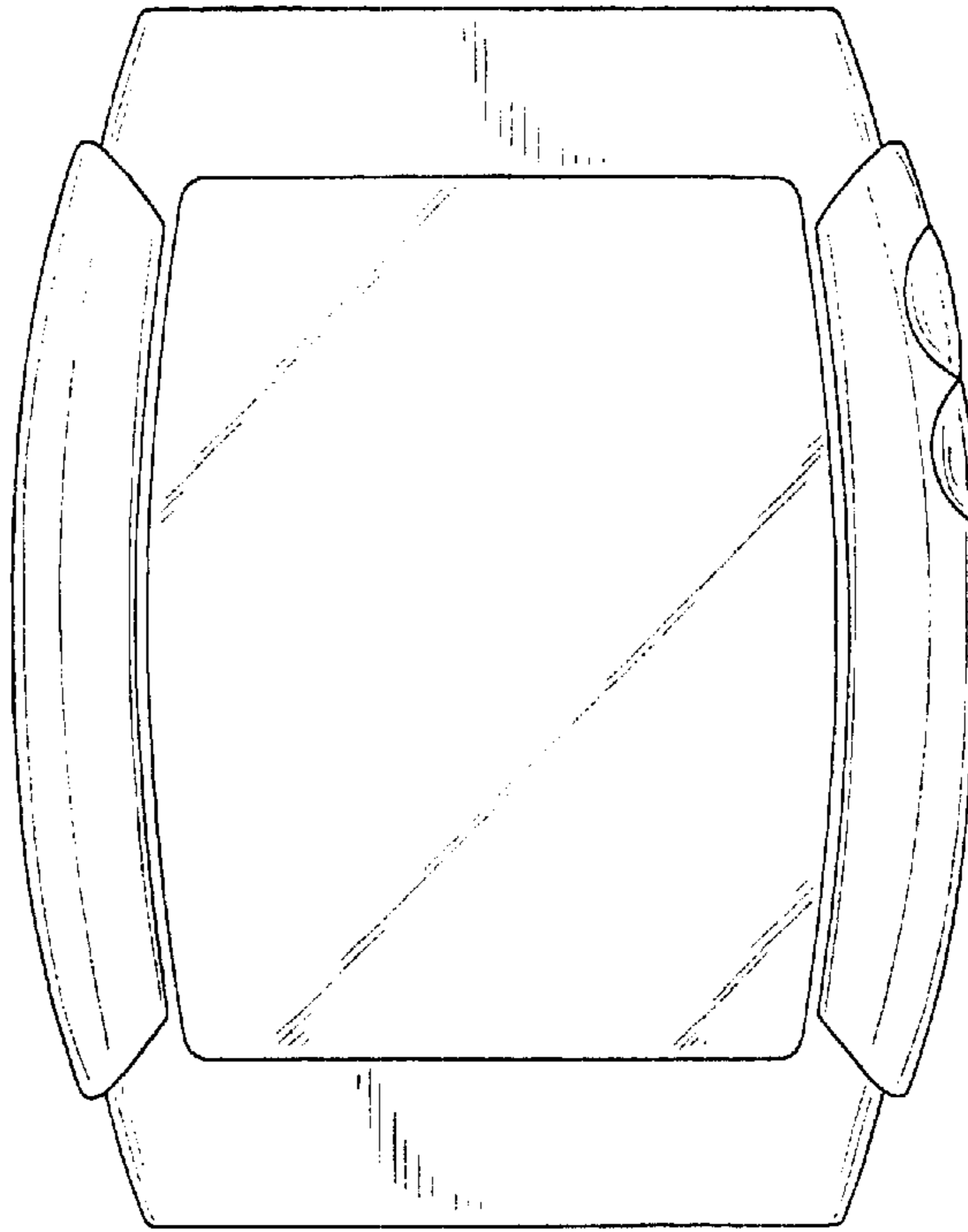
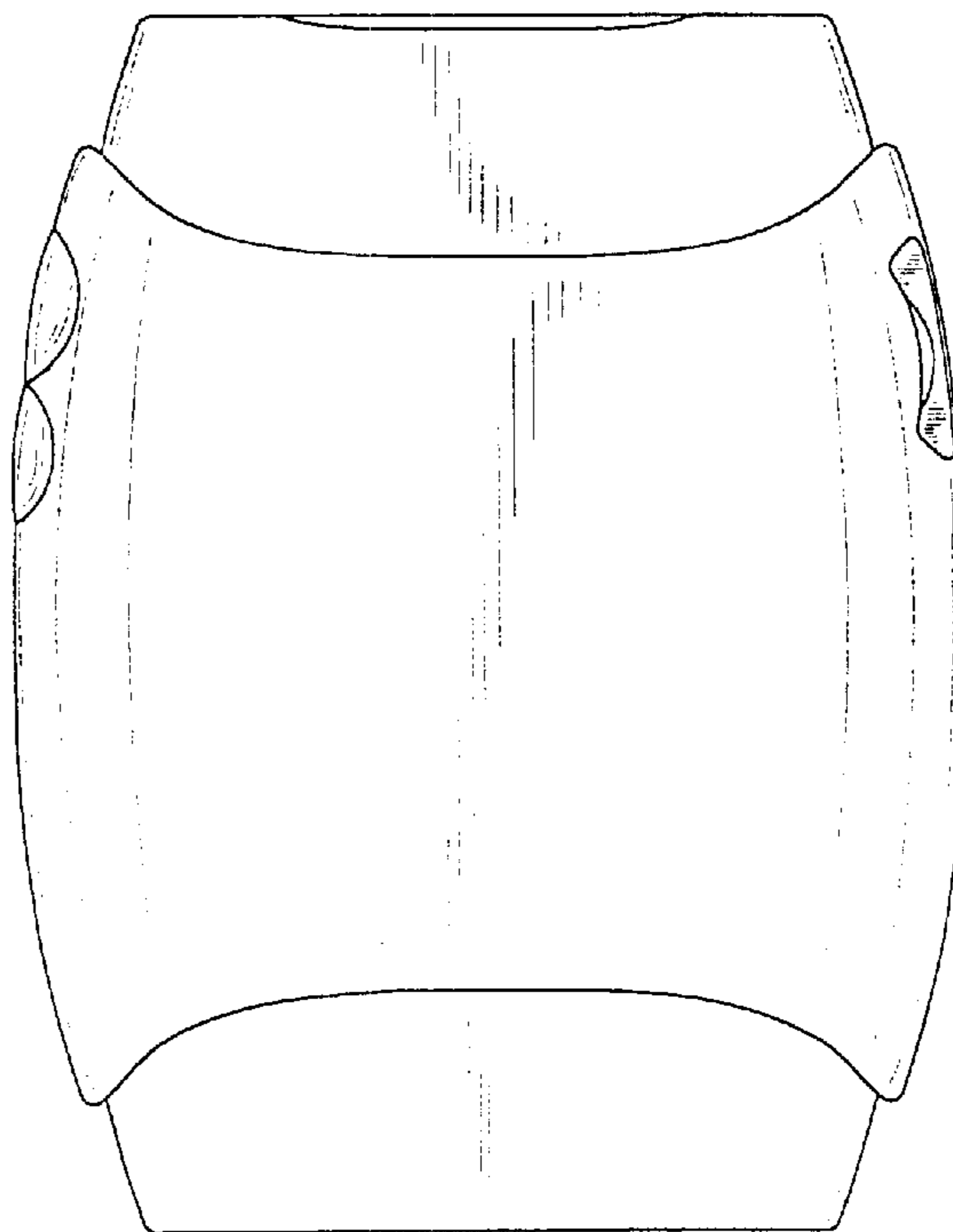

Fig. 1



**Fig. 2**



**Fig. 3**

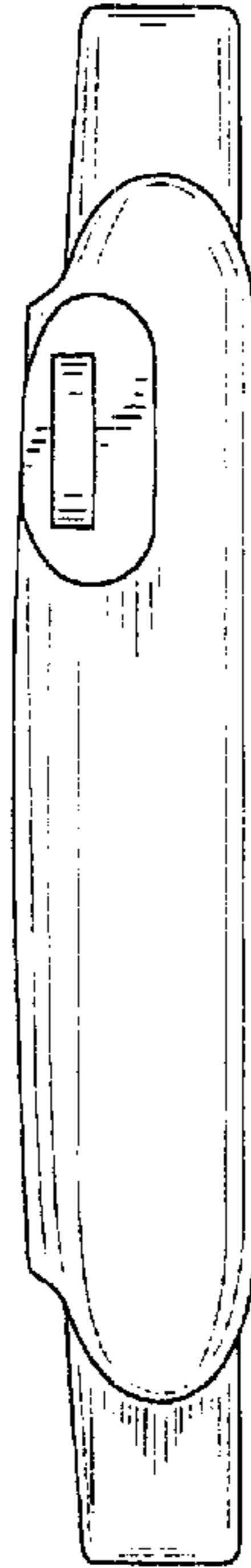

**Fig. 4**

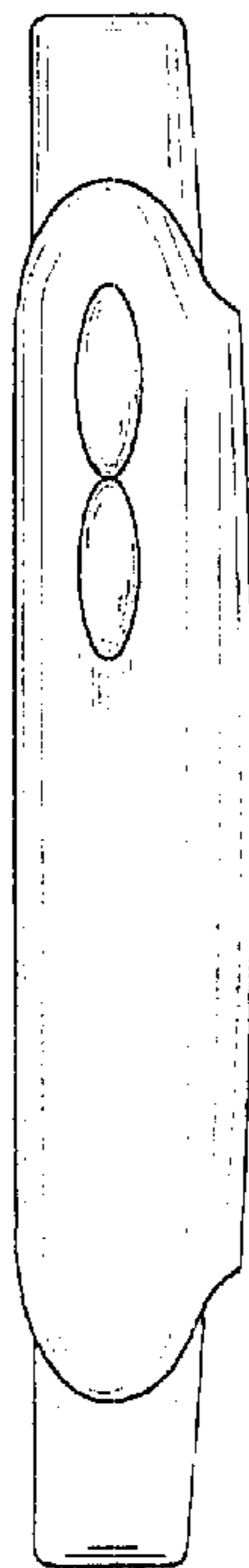

**Fig. 5**

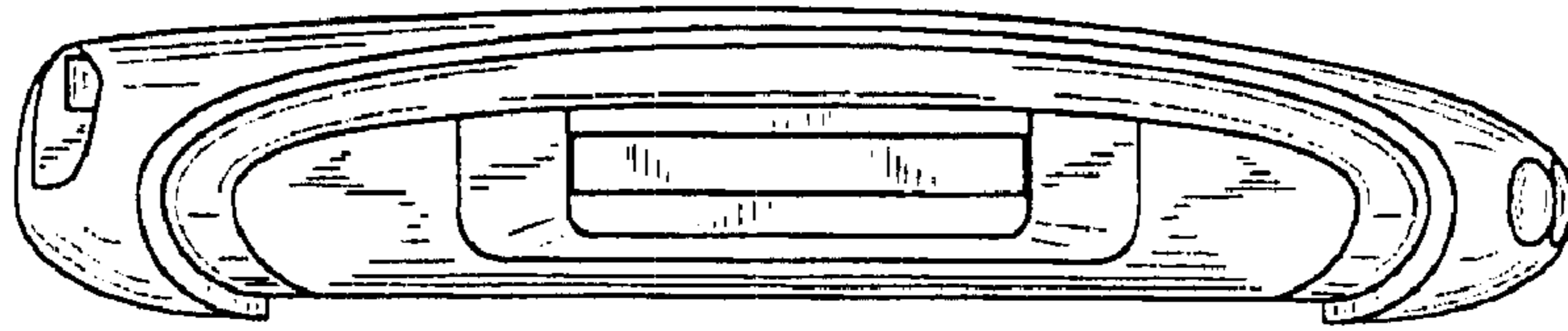

**Fig. 6**

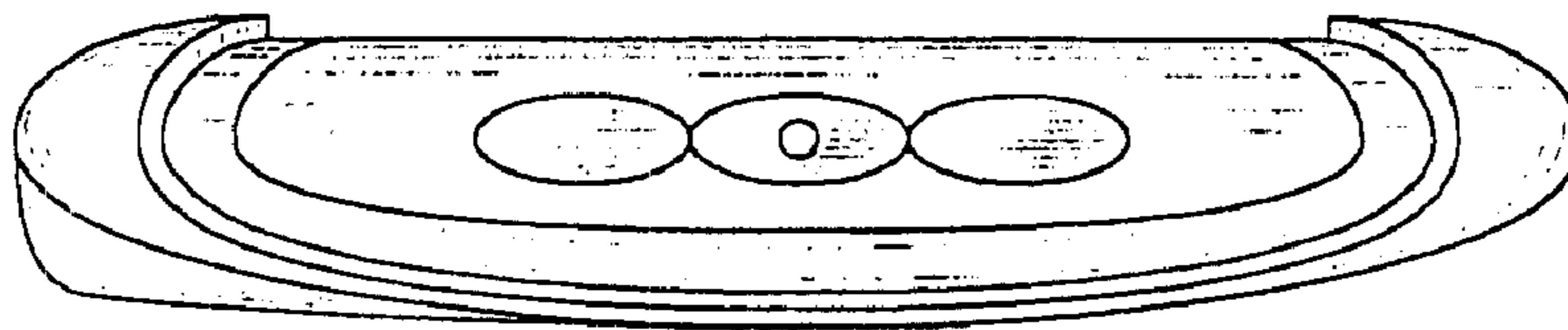

**Fig. 7**