



US00D461104S

(12) **United States Design Patent**  
**Hasegawa**

(10) **Patent No.:** **US D461,104 S**

(45) **Date of Patent:** **\*\* Aug. 6, 2002**

(54) **KNIFE HANDLE**

(75) Inventor: **Katsumi Hasegawa, Seki (JP)**

(73) Assignee: **Kai R & D Center Co., Ltd.,  
Gifu-Ken (JP)**

(\*\*) Term: **14 Years**

(21) Appl. No.: **29/142,650**

(22) Filed: **May 30, 2001**

(30) **Foreign Application Priority Data**

Dec. 6, 2000 (JP) ..... 2000-034885  
Dec. 6, 2000 (JP) ..... 2000-034888

(51) **LOC (7) Cl.** ..... **07-03**

(52) **U.S. Cl.** ..... **D7/649**

(58) **Field of Search** ..... D7/642-645, 648-650,  
D7/401.2; 30/147-150, 329, 340-345

(56) **References Cited**

**U.S. PATENT DOCUMENTS**

D164,163 S \* 8/1951 Gorton ..... D7/649  
D306,812 S \* 3/1990 Kawasaki ..... D7/649  
D426,424 S \* 6/2000 Callahan et al. .... D7/395  
D434,616 S \* 12/2000 Joergensen ..... D7/650  
D435,399 S \* 12/2000 Pease et al. .... D7/649

**OTHER PUBLICATIONS**

Photo from brochure, GM 3, Piano da lavoro in ciliegio  
tasellato, mm 660x440, date unknown.

\* cited by examiner

*Primary Examiner*—Caron D. Veynar

(74) *Attorney, Agent, or Firm*—Nilles & Nilles, S.C.

(57) **CLAIM**

The ornamental design for a knife handle, as shown and  
described.

**DESCRIPTION**

FIG. 1 is a front elevation view of a knife handle showing  
my new design;

FIG. 2 is a top plan view showing the knife handle of FIG.  
1;

FIG. 3 is a bottom plan view showing the knife handle of  
FIG. 1;

FIG. 4 is a right side elevational view showing the knife  
handle of FIG. 1;

FIG. 5 is a left side elevational view showing the knife  
handle of FIG. 1;

FIG. 6 is a cross-sectional view taken along line 6—6 of  
FIG. 1;

FIG. 7 is a cross-sectional view taken along line 7—7 of  
FIG. 1;

FIG. 8 is a cross-sectional view taken along line 8—8 of  
FIG. 1;

FIG. 9 is a cross-sectional view taken along line 9—9 of  
FIG. 1; and,

FIG. 10 is a perspective view showing the knife handle of  
FIG. 1.

The broken lines shown in FIGS. 1-5 and 10 are for  
illustrative purposes only and form no part of the claimed  
design.

**1 Claim, 2 Drawing Sheets**

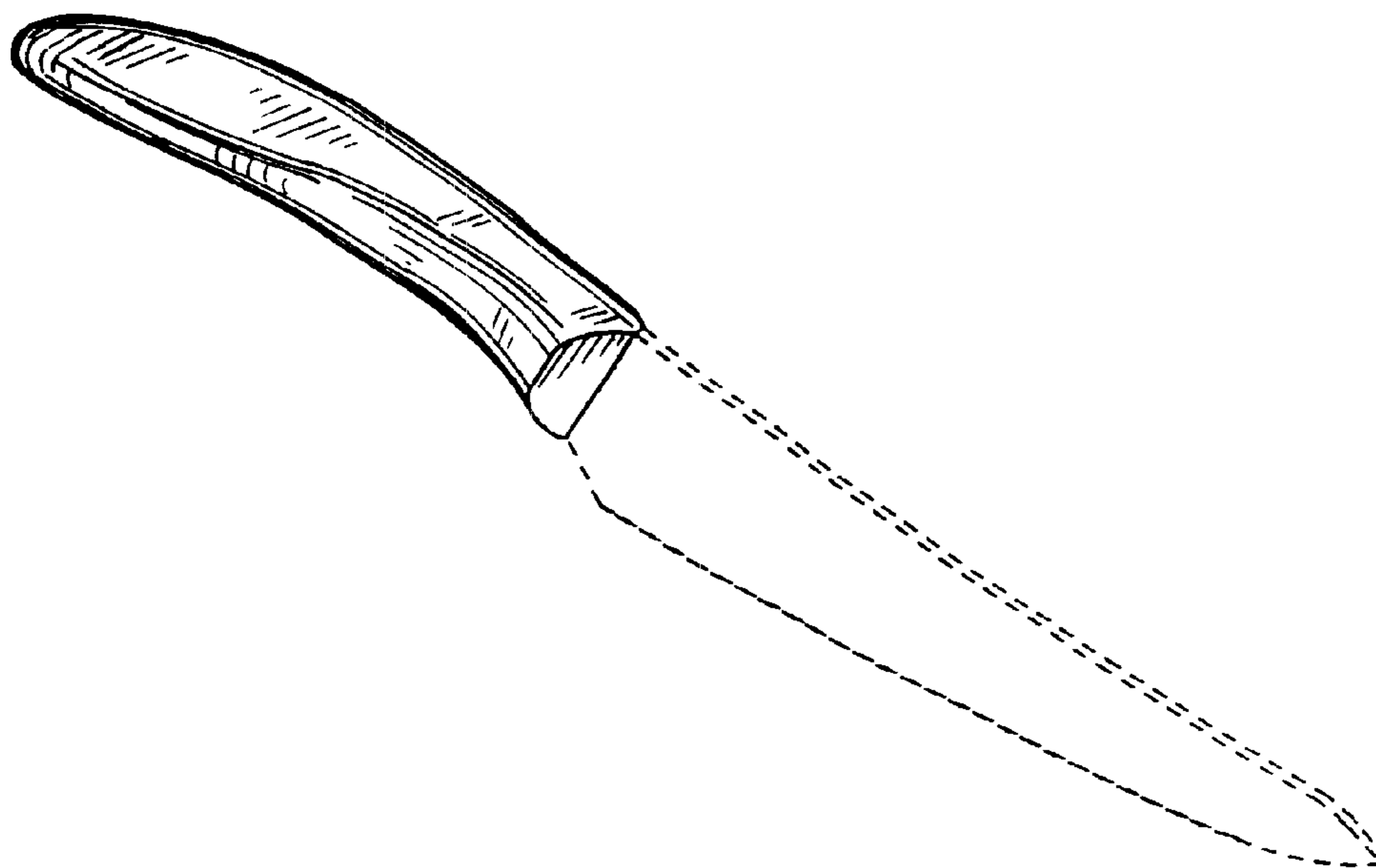

**Fig. 1**

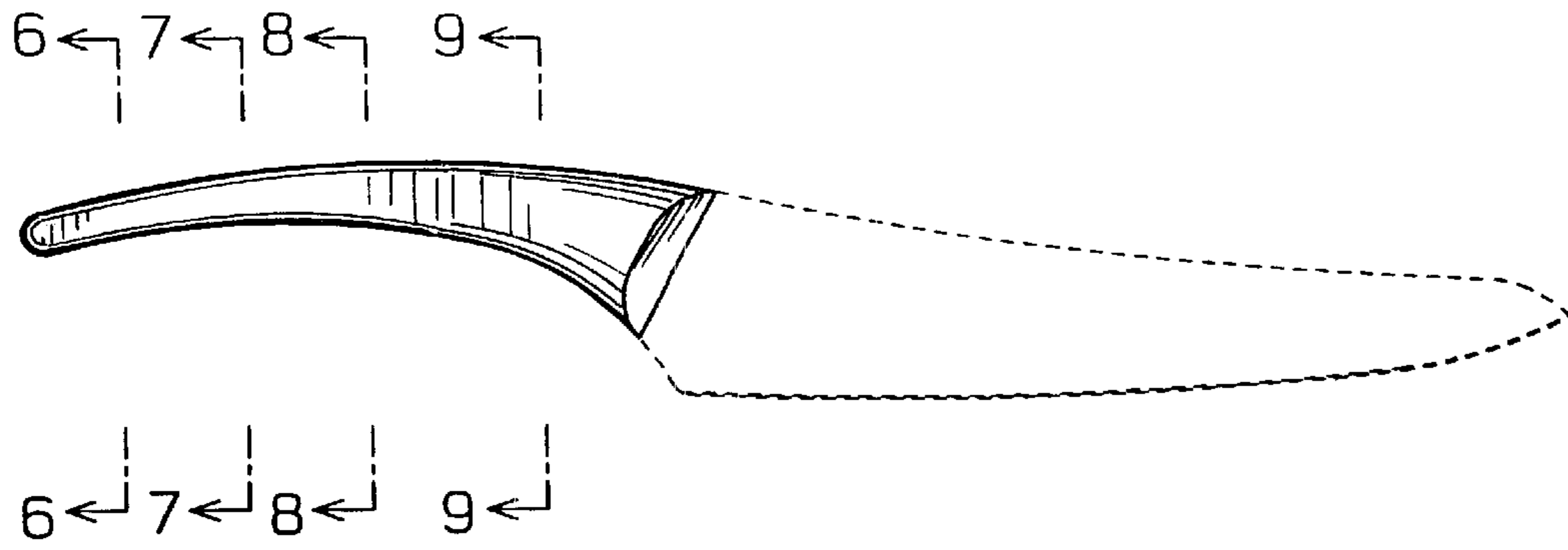

**Fig. 2**

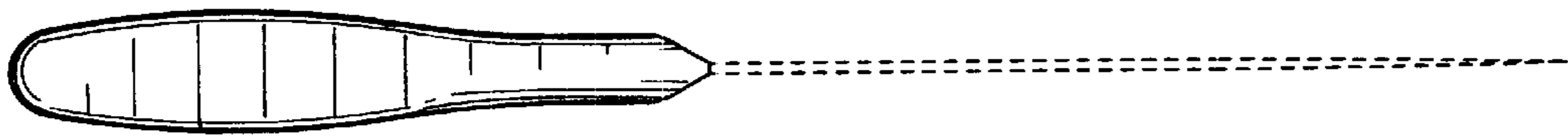

**Fig. 3**

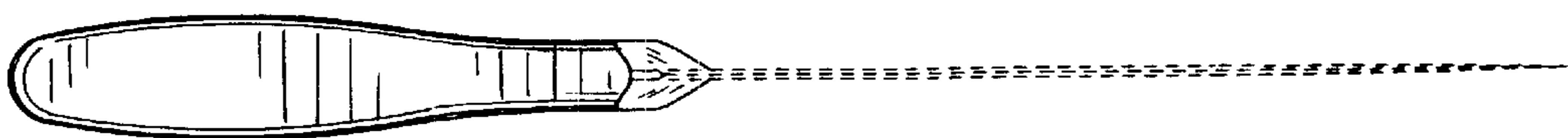

**Fig. 4**

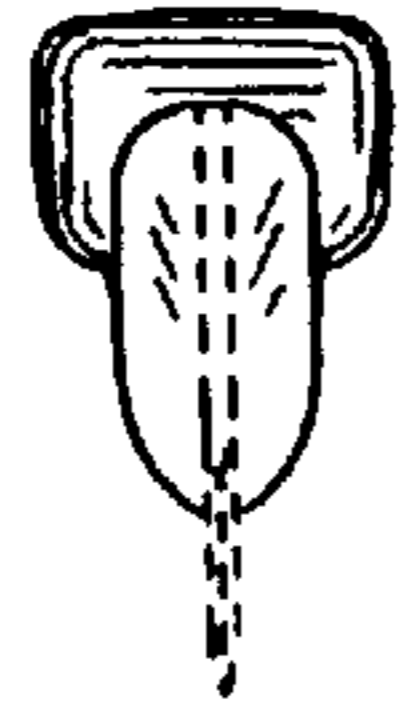

**Fig. 5**

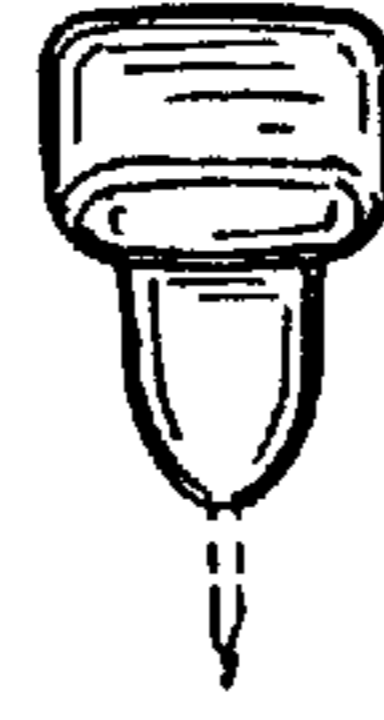

**Fig. 6**



**Fig. 7**



**Fig. 8**



**Fig. 9**

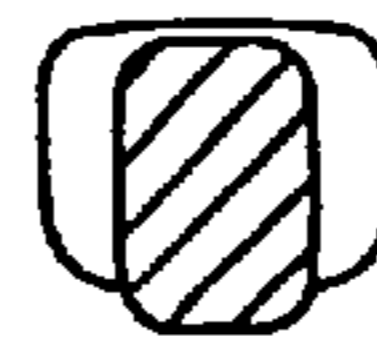

**Fig. 10**

