



US00D461063S

(12) **United States Design Patent** (10) **Patent No.:** **US D461,063 S**  
**Yu** (45) **Date of Patent:** **\*\* Aug. 6, 2002**

(54) **SADDLE FRAME**

(76) Inventor: **Tsai-Yun Yu**, No. 1-2, Lane 1147, Sec. 1, Chung San Rd., Ta Chia Chen, Taichung Hsien (TW)

(\*\*) Term: **14 Years**

(21) Appl. No.: **29/142,202**

(22) Filed: **May 22, 2001**

(51) **LOC (7) Cl.** ..... **06-01**

(52) **U.S. Cl.** ..... **D6/354; D30/138**

(58) **Field of Search** ..... D30/135, 143, D30/134; 297/219.11, 195.11, 195.1, 211, 204, 205, 215, 202; 54/38.1, 39.1, 37.1, 44.1, 44.6, 44.7, 66; D6/354

(56) **References Cited**

**U.S. PATENT DOCUMENTS**

4,099,769	A	*	7/1978	Jacobs	.....	297/205
5,387,024	A	*	2/1995	Bigolin	.....	297/202
6,007,148	A	*	12/1999	Yu	.....	297/211

\* cited by examiner

*Primary Examiner*—Pamela Burgess

(74) *Attorney, Agent, or Firm*—Browdy and Neimark, P.L.L.C.

(57) **CLAIM**

The ornamental design for a “saddle frame”, as shown and described.

**DESCRIPTION**

FIG. 1 is a rear perspective view showing my new design; FIG. 2 shows a right side elevational view of the present design.

FIG. 3 shows a top plan view of the present design.

FIG. 4 shows a front elevational view of the present design.

FIG. 5 shows a bottom plan view of the present design.

FIG. 6 shows a left side elevational view of the present design; and,

FIG. 7 shows a rear perspective view thereof, the broken lines shown are for illustrative purposes only and form no part of the claimed design.

**1 Claim, 4 Drawing Sheets**

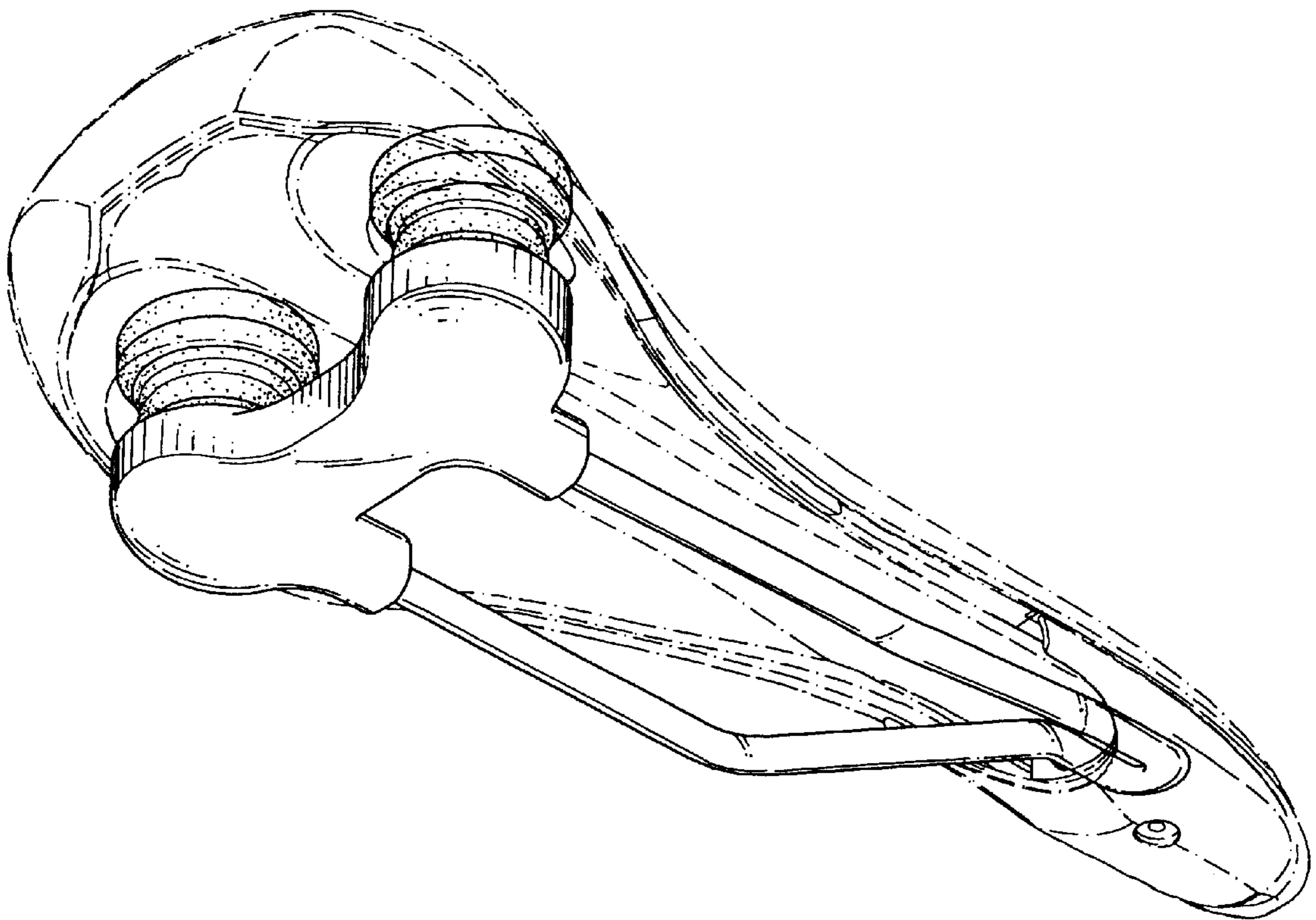

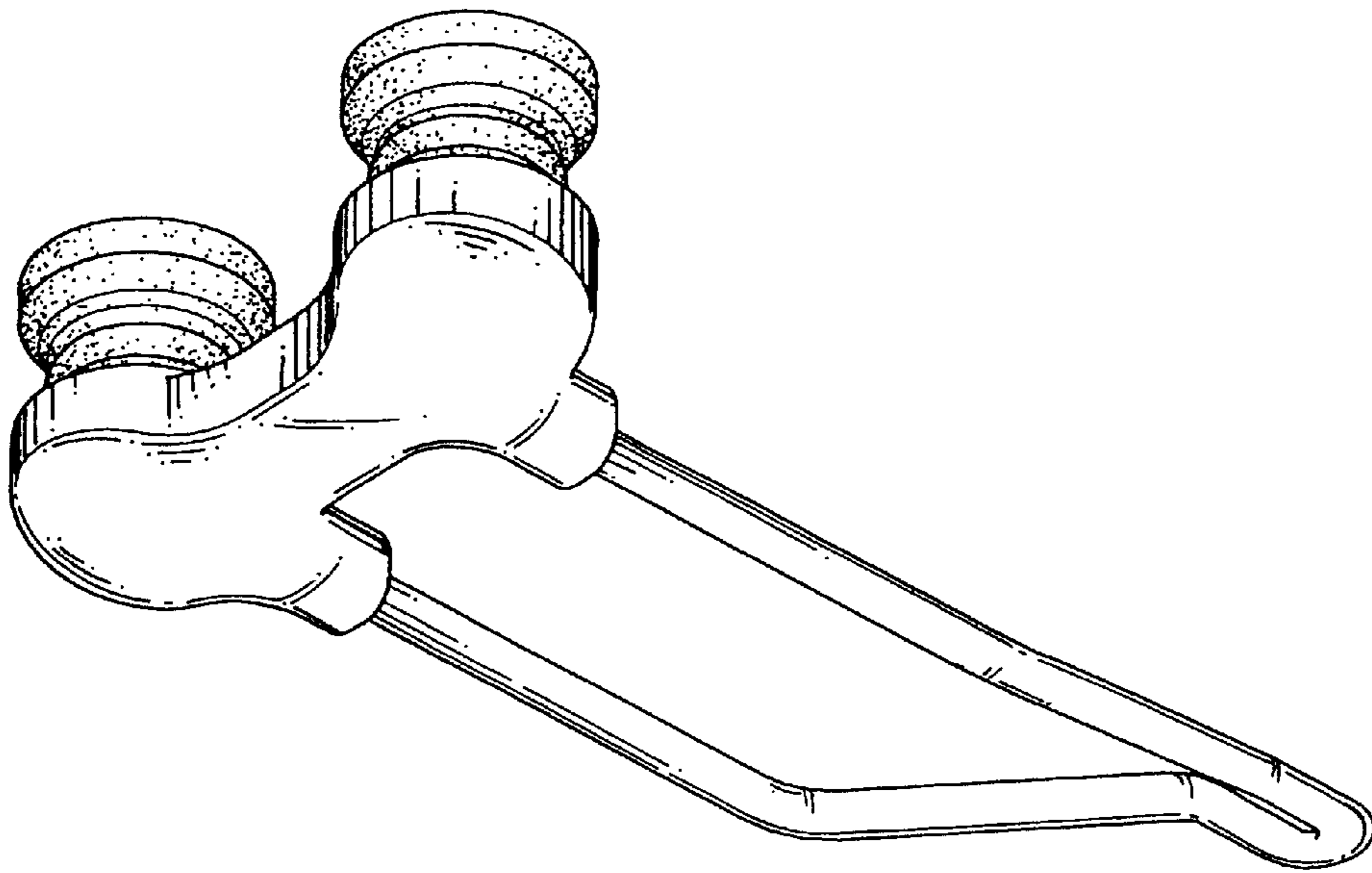

FIG. 1



FIG. 2

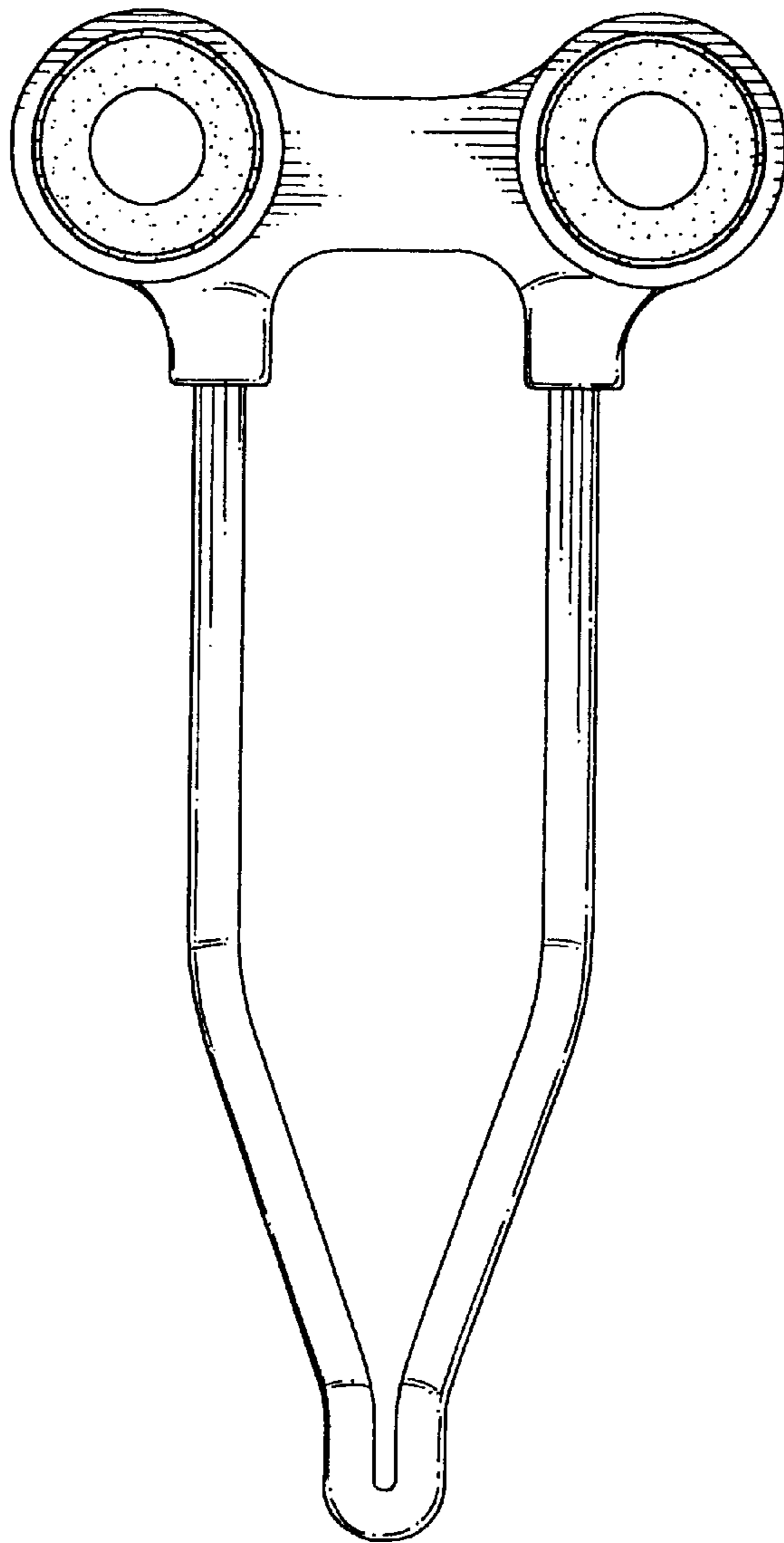

FIG. 3

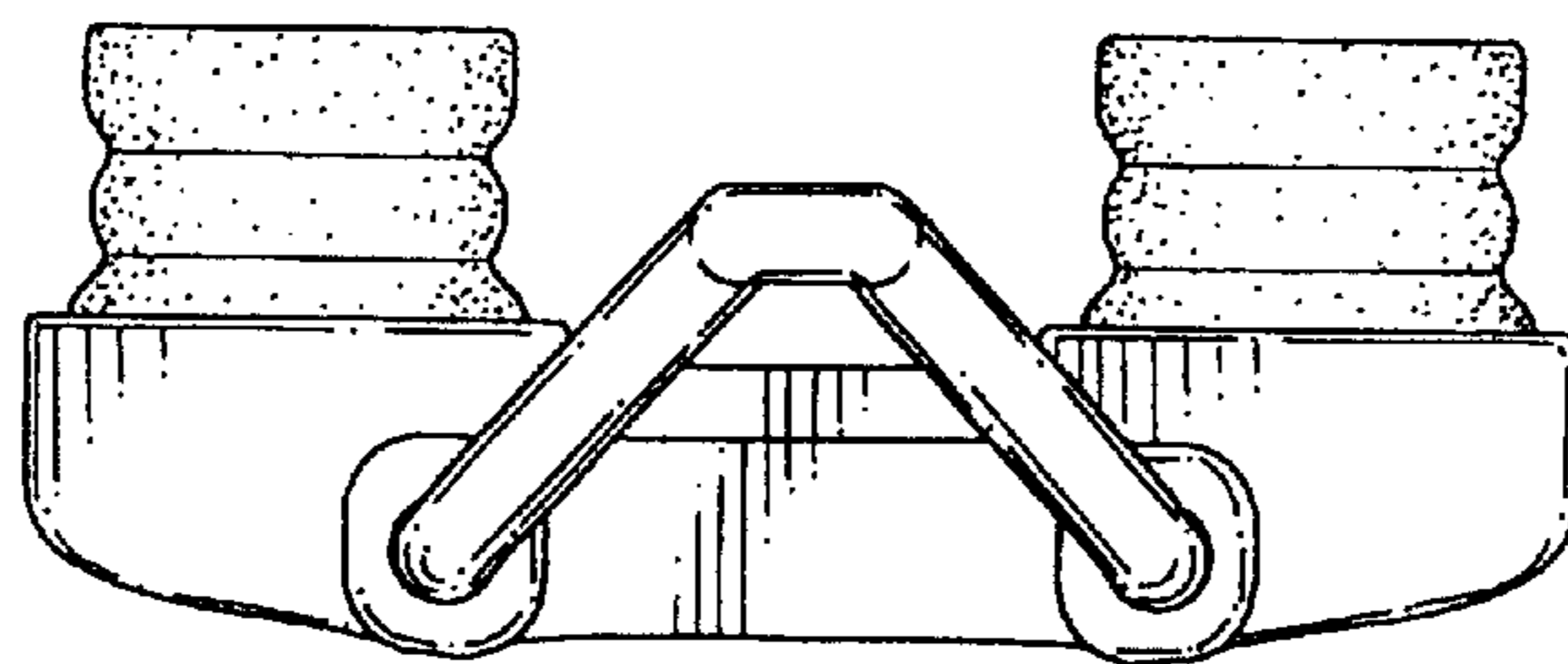

FIG. 4

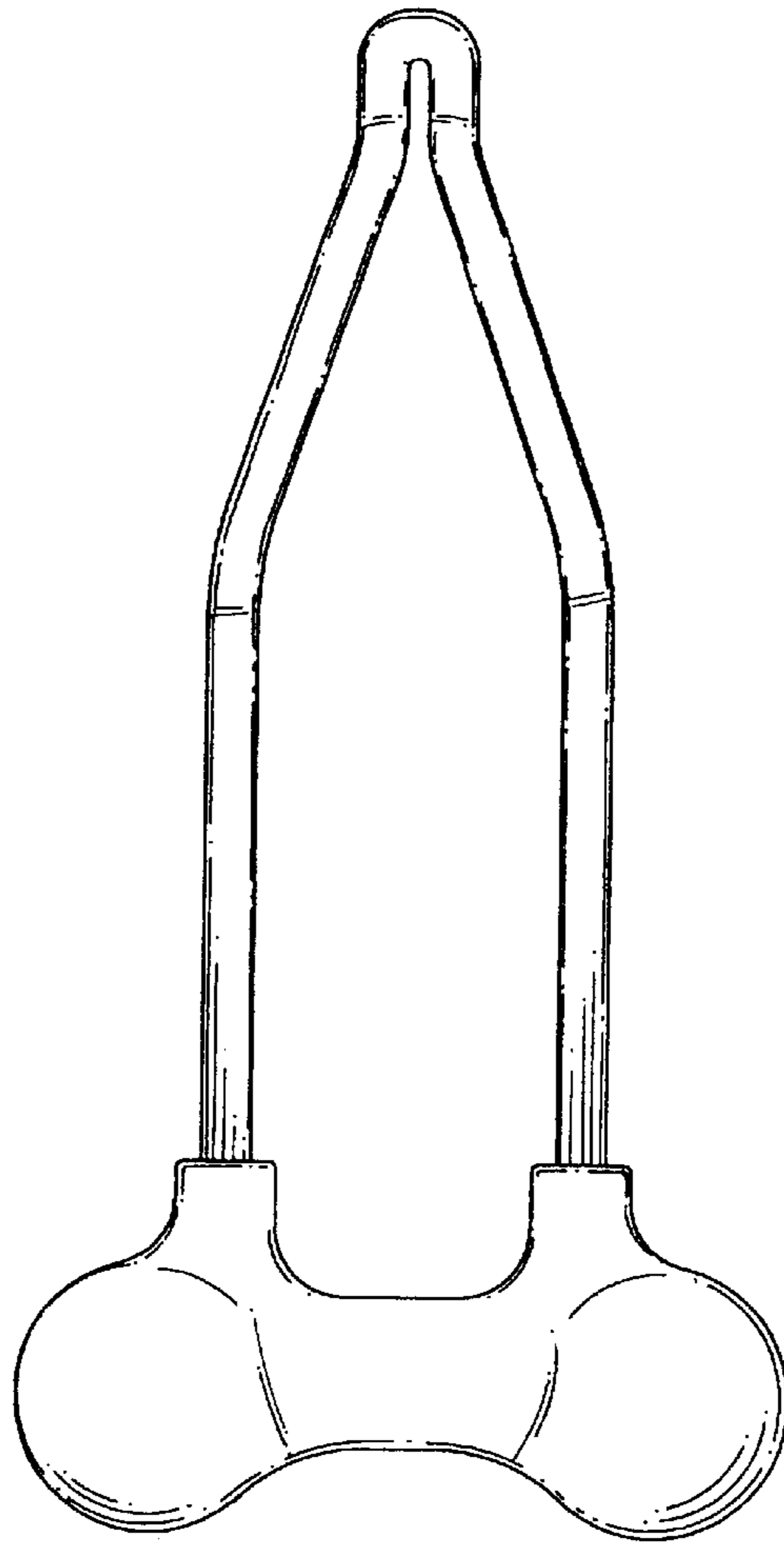

FIG. 5

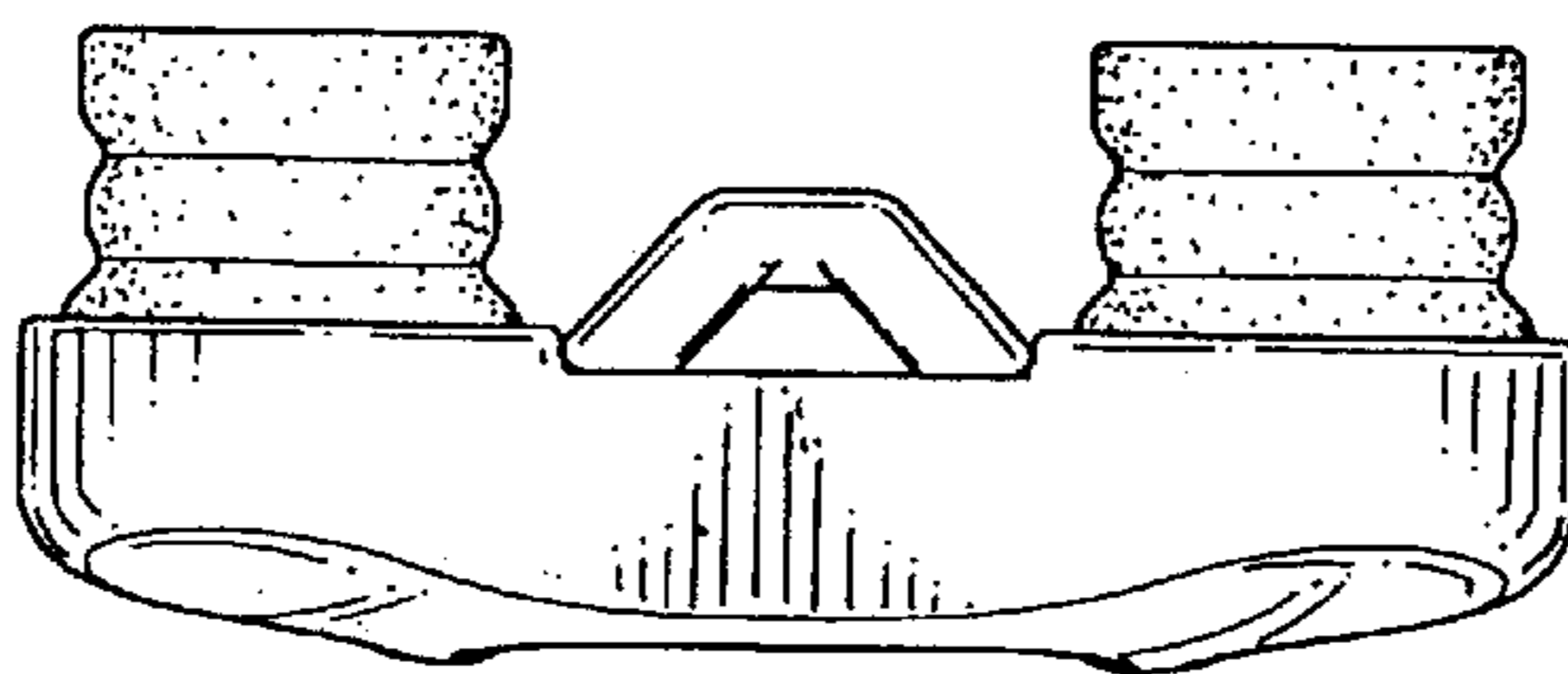

FIG. 6

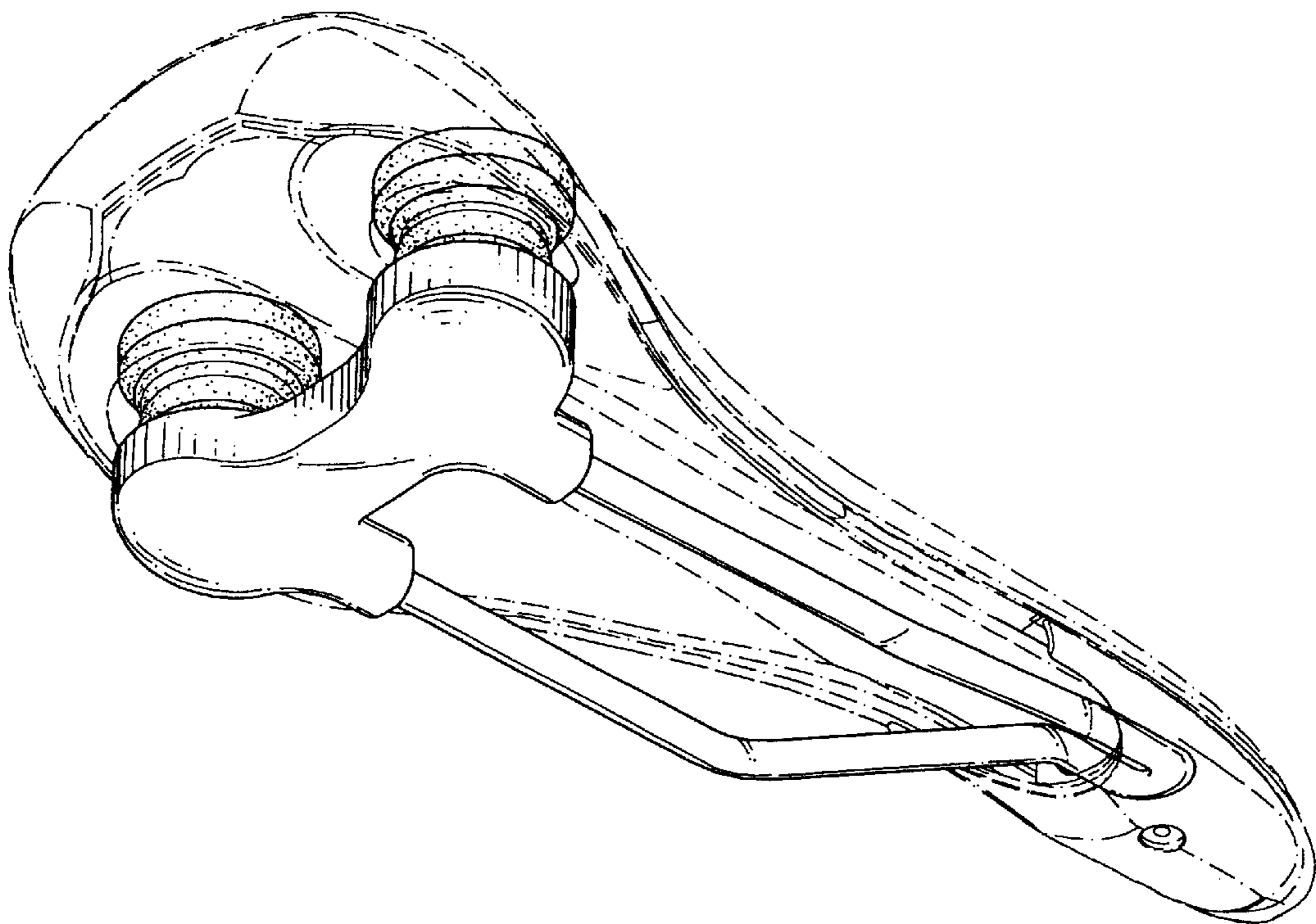

FIG. 7